

sand and mud play unit Lina

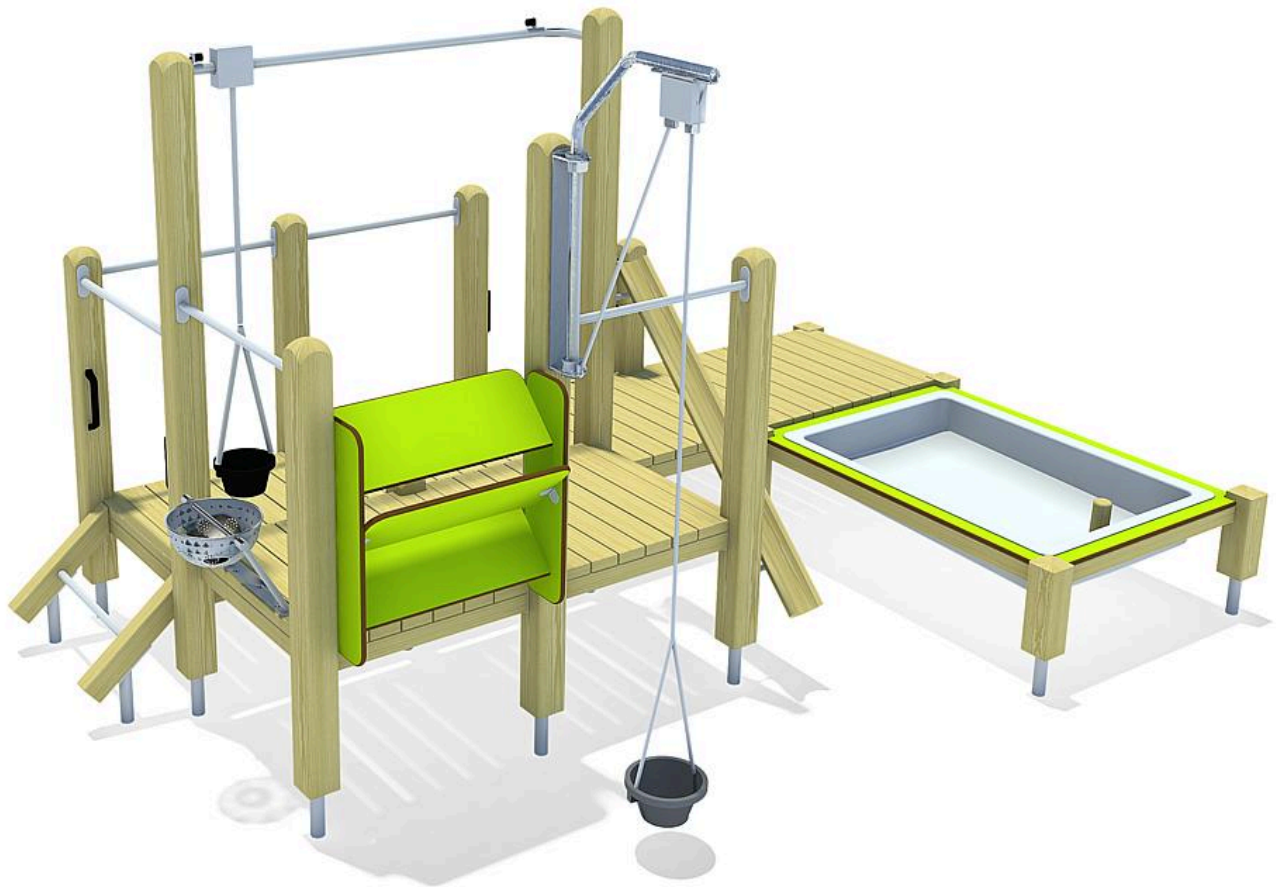

Age indication



Creativity



Living together



Experiencing the



Social skills



Recreation

Scope of delivery



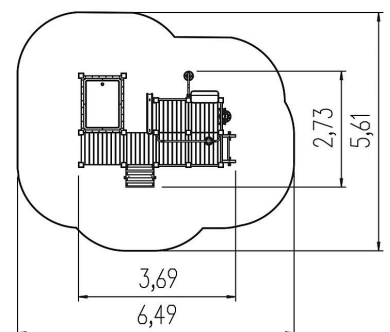
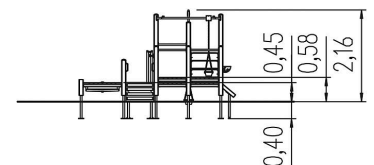





- 15x post construction: SW
- 15x post shoe: steel galvanised
- 6x platform construction: SW
- 1x aqua-basin: HPL, SW, mud tray plastic
- 5x walk-through protection leaf: stainless steel
- 2x set of grips: aluminium, plastic coated
- 1x overhead conveyor: stainless steel, rubber
- 1x ladder: SW, rungs stainless steel
- 1x ramp: HPL, SW
- 1x sand lift: stainless steel, rubber
- 1x sand chute: SW
- 1x sand slide: HPL
- 1x sand sieve: stainless steel
- fittings: stainless steel
- designed for the supervised area













sand and mud play unit Lina



Technical data

	Material	SW pi
	Minimum space	6,50x5,63x2,38 m
	Impact protection net	30,0 m ²
	Free falling height	58 cm
	Ground constitution GE/NL/B	at least stone
	Ground constitution all except GE/NL/B	at least stone
	Certificate	Z2_010651_514_Rev00
	Tested according to standard	EN 1176 - 1/7

Installation information

	Foundations	17x CF or 17x PFs
	Fundamentlevel	ET 400
	Assembly	2 persons/8 h
	PF Accessories	17x 5632540
	PF drainage	-
	PF concrete	-
	PF excavation	1,59 m ³
	CF drainage	-
	CF concrete	0,96 m ³
	CF excavation	2,24 m ³



5 11 029 011 10

sand and mud play unit Lina



CO₂ emissions of the product 1045,1 kg

Material share of renewable raw materials 65%

Recyclate content 22%

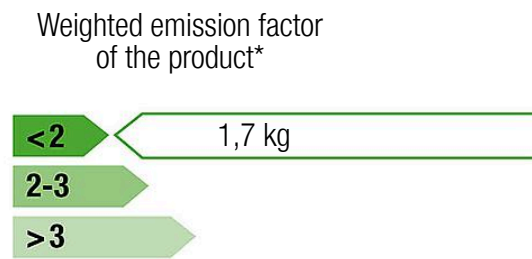

Disclaimer:

This dashboard for the circularity index of the 'Circular Product' certification was generated automatically and is based on the corresponding certification of eibe Produktion + Vertrieb GmbH & Co KG, Industriestraße 1, 97285 Röttingen, which was issued on 16 May 2024 by the Gesellschaft für Klimaschutz München GmbH (GKM GmbH) on the basis of the example product Albion play unit from the eibe unique® product line. eibe Produktion + Vertrieb GmbH & Co KG is liable for the accuracy of the contents. The award criteria of the private-law certification 'Circular Product' of GKM GmbH can be viewed at gesellschaft-klimaschutz.de/zertifizierung/zirkularitaet/.

* The CO₂e emissions of the materials used in the product are taken into account. The emissions that arise during the production process are allocated to the product on a pro-rata basis.

created on: 14 August 2024