

play unit Jannu, solo



Age indication



Fitness



Fine motor skills



Speed

Scope of delivery



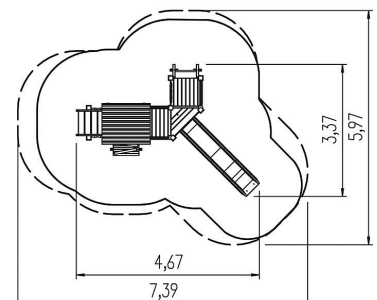
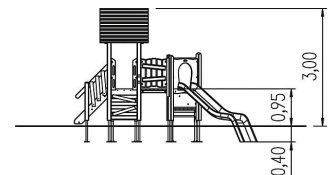







2x adapter: softwood or steel
 11x post construction: softwood or steel
 4x platform construction: softwood
 1x pent roof: softwood
 1x climbing board: high pressure laminate (HPL), climbing grips
 1x sloped ladder: softwood, stainless steel
 1x vertical ladder: stainless steel
 1x ramp: softwood
 1x staircase: softwood
 1x parapet: high pressure laminate (HPL)
 3x parapet: softwood
 1x walk-through protective device: stainless steel
 1x slide entry plate: high pressure laminate (HPL)
 2x access restriction: high pressure laminate (HPL)
 1x play parapet gearwheel: high pressure laminate (HPL)
 6x decoration timber: softwood
 2x set of grips: aluminium, plastic-coated
 1x filling timber: softwood
 fittings: stainless steel













play unit Jannu, solo



Technical data

	Material	SW pi
	Minimum space	6,91x5,61x3,00 m
	Impact protection net	23,0 m ²
	Free falling height	95 cm
	Ground constitution GE/NL/B	at least turf
	Ground constitution all except GE/NL/B	at least turf
	Largest section	10x10x294 cm
	mx. number of users	16
	Certificate	Z2-010651-0526_ZERT
	Tested according to standard	EN 1176 - 1/3/7

Installation information

	Foundations	15x CF or 11x PFs
	Fundamentlevel	ET 400
	Assembly	2 persons/8 h
	PF Accessories	11x 5632540
	PF drainage	-
	PF concrete	-
	PF excavation	2,50 m ³
	CF Accessories	15x 5631120
	CF drainage	-
	CF concrete	0,72 m ³
	CF excavation	1,68 m ³

Accessories

-  Slides for platform heights: 1x 95 cm
- Installation accessories e.g. PF
- Please order accessories separately to complete the appliance.



5 11 517 011 00

play unit Jannu, solo



CO₂ emissions of the product

784 kg

Material share of renewable raw materials

77%

Recyclate content

12%

Circularity score



Weighted emission factor of the product*



Disclaimer:

This dashboard for the circularity index of the 'Circular Product' certification was generated automatically and is based on the corresponding certification of eibe Produktion + Vertrieb GmbH & Co KG, Industriestraße 1, 97285 Röttingen, which was issued on 16 May 2024 by the Gesellschaft für Klimaschutz München GmbH (GKM GmbH) on the basis of the example product Albion play unit from the eibe unique® product line. eibe Produktion + Vertrieb GmbH & Co KG is liable for the accuracy of the contents. The award criteria of the private-law certification 'Circular Product' of GKM GmbH can be viewed at gesellschaft-klimaschutz.de/zertifizierung/zirkularitaet/.

* The CO₂e emissions of the materials used in the product are taken into account. The emissions that arise during the production process are allocated to the product on a pro-rata basis.

created on: 14 August 2024