

hexagonal swing



Age indication



Social skills



Senses



Speed

Scope of delivery



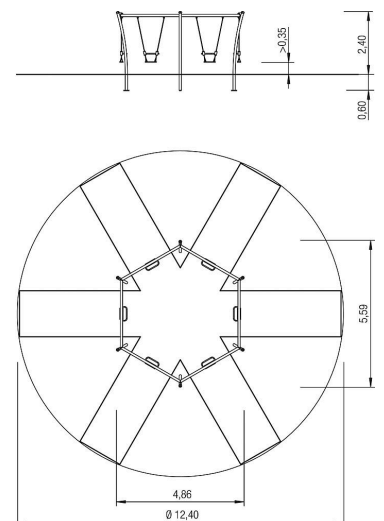



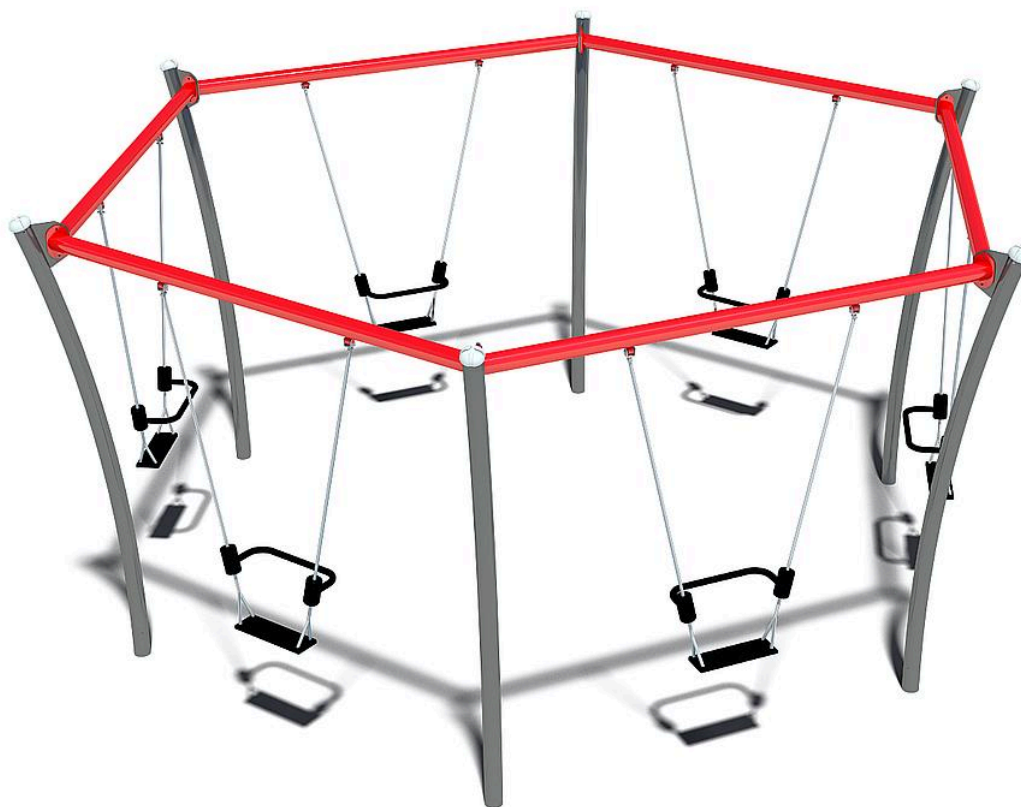



- 1x swing frame: galvanised and powder-coated steel
- 6x swing seats: safety swing seat with jump-off protection and VA-stainless steel chain
- 12x swing joint: POM-bearing, stainless steel
- 6x post cover: PA6





hexagonal swing



Technical data

	Material	powdered steel
	Minimum space	Ø 12,40x3,20 m
	Impact protection net	121,0 m ²
	Free falling height	140 cm
	Ground constitution GE/NL/B	at least lawn
	Ground constitution all except GE/NL/B	at least lawn
	Largest section	305x30x10 cm
	Heaviest section	40 kg
	Certificate	TÜV product service
	Tested according to standard	EN 1176 - 1/2/7
	Service interval (in months)	6

Installation information

	Foundations	6x CF
	Fundamentlevel	ET 900
	Assembly	2 persons/5 h