

play unit Cherry



Age indication



Imagination



Fitness



Recreation



Fine motor skills

Scope of delivery

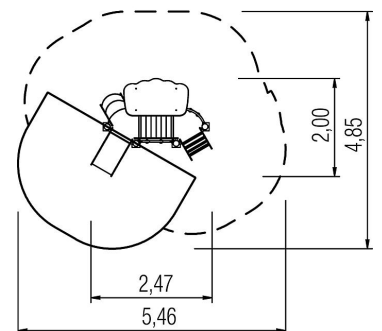
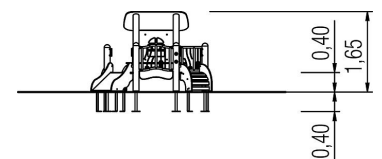

- 1x roof: high-pressure laminate (HPL)
- 1x bench: high-pressure laminate (HPL)
- 1x wall element with window and shutters: high-pressure laminate (HPL), stainless steel
- 1x belly board: high-pressure laminate (HPL)
- 1x arched ramp: softwood, high-pressure laminate (HPL)
- 1x staircase: high-pressure laminate (HPL)
- 2x platform: high-pressure laminate (HPL), softwood
- 2x fence elements: stainless steel, PE
- 1x set posts with post bases: softwood, galvanised steel



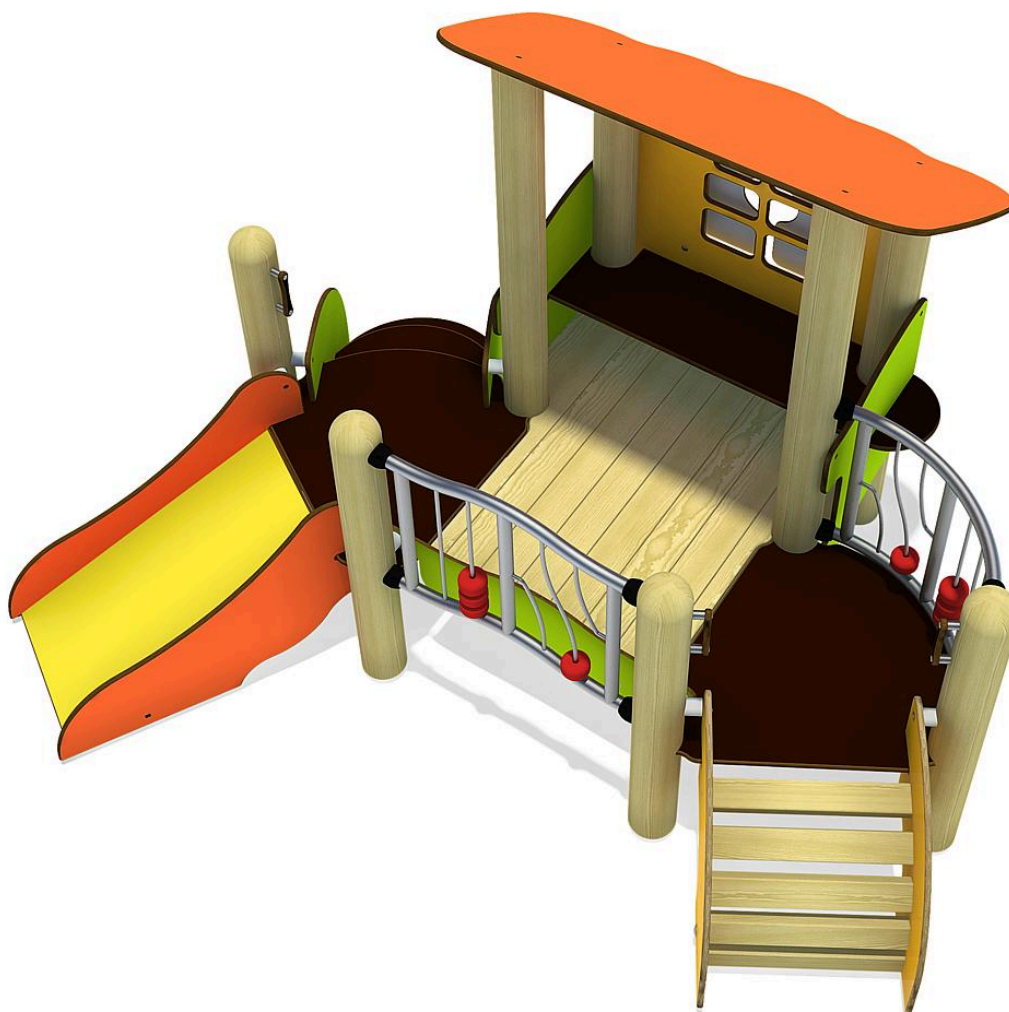









play unit Cherry



Technical data

	Material	SW pi
	Minimum space	5,46x4,85x2,20 m
	Impact protection net	7,5 m ²
	Free falling height	40 cm
	Ground constitution GE/NL/B	at least lawn
	Ground constitution all except GE/NL/B	at least lawn
	Largest section	132x88x1,5 cm
	Heaviest section	23 kg
	mx. number of users	15
	Tested according to standard	EN 1176 - 1/3/7
	Service interval (in months)	6

Installation information

	Foundations	11x CF or 3x PFs + 8x PFr
	Fundamentlevel	ET 400
	Assembly	2 persons/3 h
	PF Accessories	3x 5632540 + 8x 5632550
	PF drainage	-
	PF concrete	-
	PF excavation	0,66 m ³
	CF Accessories	-
	CF drainage	-
	CF concrete	0,40 m ³
	CF excavation	1,20 m ³

Legend: PF=prefabricated foundation, CF=concrete foundation, ET=burial depth, GFRP=glass-fibre reinforced plastic, VA=stainless steel, PH=platform height



5 59 835 011 00

play unit Cherry



CO₂ emissions of the product

571,4 kg

Material share of renewable raw materials

36%

Recyclate content

15%

Circularity score



Weighted emission factor of the product*



Disclaimer:

This dashboard for the circularity index of the 'Circular Product' certification was generated automatically and is based on the corresponding certification of eibe Produktion + Vertrieb GmbH & Co KG, Industriestraße 1, 97285 Röttingen, which was issued on 16 May 2024 by the Gesellschaft für Klimaschutz München GmbH (GKM GmbH) on the basis of the example product Albion play unit from the eibe unique® product line. eibe Produktion + Vertrieb GmbH & Co KG is liable for the accuracy of the contents. The award criteria of the private-law certification 'Circular Product' of GKM GmbH can be viewed at gesellschaft-klimaschutz.de/zertifizierung/zirkularitaet/.

* The CO₂e emissions of the materials used in the product are taken into account. The emissions that arise during the production process are allocated to the product on a pro-rata basis.

created on: 14 August 2024