

5 15 101 011 00

Park bench Vogelsberg



Age indication



Social skills



Living together



Recreation

Scope of delivery

4x stand: galvanised steel
1x platform: softwood
4x round timber: softwood

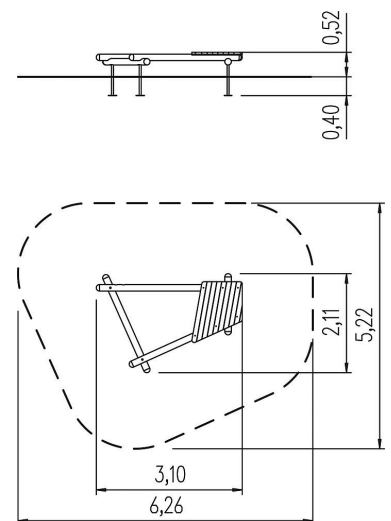











Park bench Vogelsberg



Technical data

	Material	SW pi
	Minimum space	6,26x5,22x2,32 m
	Impact protection net	-
	Free falling height	52 cm
	Ground constitution GE/NL/B	at least stone
	Ground constitution all except GE/NL/B	at least stone
	Largest section	310x14x14 cm

Installation information

	Foundations	4x CF or 4x FFP
	Fundamentlevel	ET 400
	Assembly	2 persons/1.5 h
	PF Accessories	4x 5632540
	PF drainage	-
	PF concrete	-
	PF excavation	0,37 m ³
	CF Accessories	-
	CF drainage	-
	CF concrete	0,19 m ³
	CF excavation	0,45 m ³



5 15 101 011 00

Park bench Vogelsberg



CO₂ emissions of the product

142,1 kg

Material share of renewable raw materials

91%

Recyclate content

8%

Circularity score



Weighted emission factor of the product*



Disclaimer:

This dashboard for the circularity index of the 'Circular Product' certification was generated automatically and is based on the corresponding certification of eibe Produktion + Vertrieb GmbH & Co KG, Industriestraße 1, 97285 Röttingen, which was issued on 16 May 2024 by the Gesellschaft für Klimaschutz München GmbH (GKM GmbH) on the basis of the example product Albion play unit from the eibe unique® product line. eibe Produktion + Vertrieb GmbH & Co KG is liable for the accuracy of the contents. The award criteria of the private-law certification 'Circular Product' of GKM GmbH can be viewed at gesellschaft-klimaschutz.de/zertifizierung/zirkularitaet/.

* The CO₂e emissions of the materials used in the product are taken into account. The emissions that arise during the production process are allocated to the product on a pro-rata basis.

created on: 14 August 2024