

# hexagonal system 210

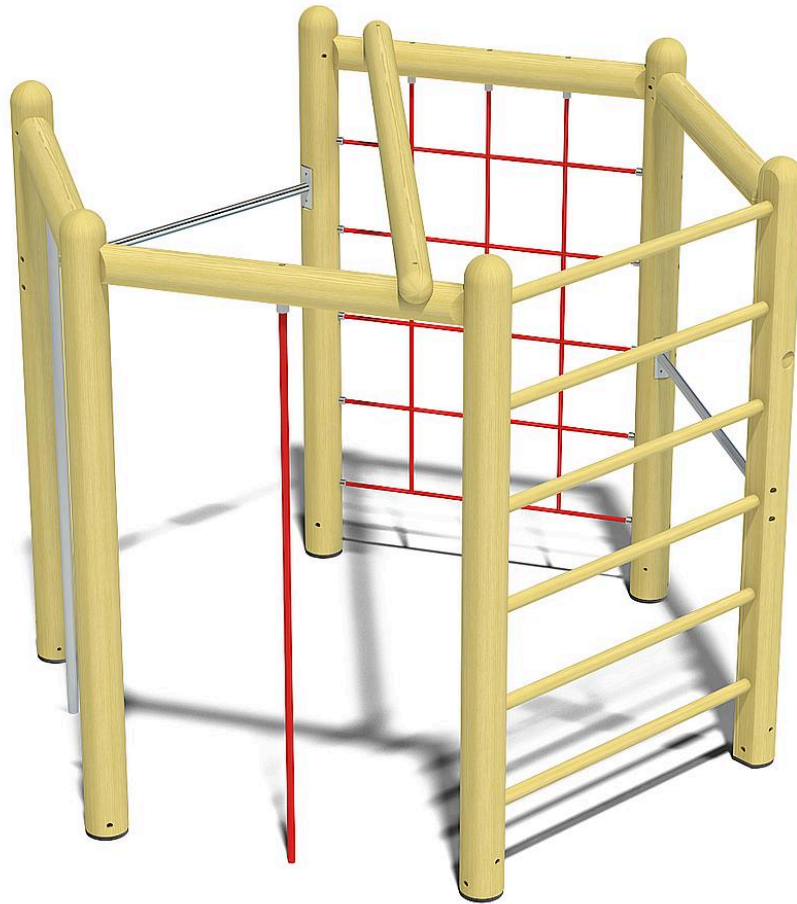

Age indication



Fitness



Living together



Social skills



Senses



Balance

## Scope of delivery



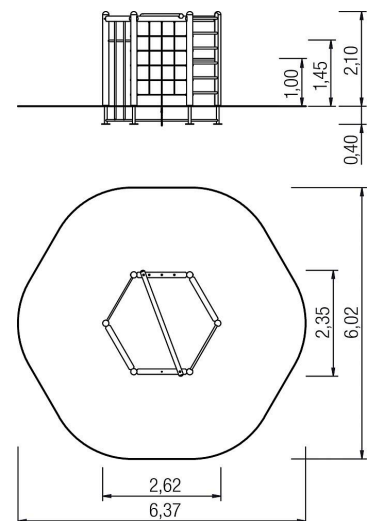

- 1x rung element: softwood, ash
- 2x horizontal bar: galvanised and powder-coated steel
- 2x firemans pole: powder-coated steel
- 1x climbing net: plastic-coated steel cable
- 1x climbing rope: plastic-coated cable
- wood structure H 200 cm: softwood
- post bases: galvanised steel













# hexagonal system 210



## Technical data

	Material	SW pi
	Minimum space	6,37x6,02x2,10 m
	Impact protection net	31,5 m <sup>2</sup>
	Free falling height	205 cm
	Ground constitution GE/NL/B	at least sand
	Ground constitution all except GE/NL/B	at least sand
	Largest section	250x139x14 cm
	Heaviest section	120 kg
	Certificate	TÜV product service
	Tested according to standard	-
	Service interval (in months)	6

## Installation information

	Foundations	6x CF or 6x PFs
	Fundamentlevel	ET 400
	Assembly	2 persons/3 h
	PF Accessories	6x 5632540
	PF drainage	-
	PF concrete	-
	PF excavation	0,57 m <sup>3</sup>
	CF Accessories	6x 5631120
	CF drainage	-
	CF concrete	0,29 m <sup>3</sup>
	CF excavation	0,68 m <sup>3</sup>

Legend: PF=prefabricated foundation, CF=concrete foundation, ET=burial depth, GFRP=glass-fibre reinforced plastic, VA=stainless steel, PH=platform height



5 55 010 5

# hexagonal system 210



**CO<sub>2</sub> emissions of the product**

**344,1 kg**

**Material share of renewable raw materials**

**78%**

**Recyclate content**

**18%**

Circularity score



Weighted emission factor of the product\*



**Disclaimer:**

This dashboard for the circularity index of the 'Circular Product' certification was generated automatically and is based on the corresponding certification of eibe Produktion + Vertrieb GmbH & Co KG, Industriestraße 1, 97285 Röttingen, which was issued on 16 May 2024 by the Gesellschaft für Klimaschutz München GmbH (GKM GmbH) on the basis of the example product Albion play unit from the eibe unique® product line. eibe Produktion + Vertrieb GmbH & Co KG is liable for the accuracy of the contents. The award criteria of the private-law certification 'Circular Product' of GKM GmbH can be viewed at [gesellschaft-klimaschutz.de/zertifizierung/zirkularitaet/](https://gesellschaft-klimaschutz.de/zertifizierung/zirkularitaet/).

\* The CO<sub>2</sub>e emissions of the materials used in the product are taken into account. The emissions that arise during the production process are allocated to the product on a pro-rata basis.

created on: 14 August 2024