

two-seater seesaw



Age indi-
cation



Balance



Social
skills



Senses





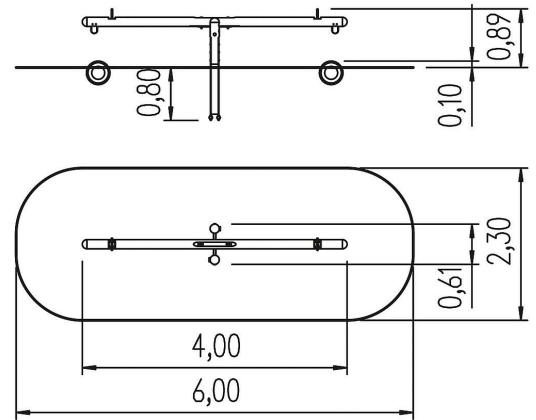







Scope of delivery

- 1x seesaw beam: softwood
- 2x seesaw posts: softwood
- 2x handle: stainless steel
- 2x tyres: rubber
- post shoes: galvanised steel













two-seater seesaw

Technical data

| | | |
|-----------------------------------------------------------------------------------|-------------------------------------------|---------------------|
|  | Material | Larch natural |
|  | Minimum space | 6,86x3,14x3,01 m |
|  | Impact protection net | 12,0 m ² |
|  | Free falling height | 121 cm |
|  | Ground constitution GE/NL/B | at least lawn |
|  | Ground constitution all except GE/NL/B | minimum sand |
|  | Largest section | Ø 16x400 cm |
|  | Heaviest section | 60 kg |
|  | mx. number of users | 2 |
|  | Certificate | TÜV product service |
|  | Tested according to standard | EN 1176 - 1/6/7 |
|  | Service interval (in months) | 6 |

Installation information

| | | |
|-----------------------------------------------------------------------------------|----------------|---------------------|
|  | Foundations | 1x CF |
|  | Fundamentlevel | ET 800 |
|  | Assembly | 2 persons/2 h |
|  | PF Accessories | - |
|  | PF drainage | - |
|  | PF concrete | - |
|  | PF excavation | - |
|  | CF Accessories | - |
|  | CF drainage | 0,06 m ³ |
|  | CF concrete | 0,26 m ³ |
|  | CF excavation | 0,58 m ³ |



5 55 090 033 00

two-seater seesaw



CO₂ emissions of the product

237,2 kg

Material share of renewable raw materials

60%

Recyclate content

29%

Circularity score



Weighted emission factor of the product*



Disclaimer:

This dashboard for the circularity index of the 'Circular Product' certification was generated automatically and is based on the corresponding certification of eibe Produktion + Vertrieb GmbH & Co KG, Industriestraße 1, 97285 Röttingen, which was issued on 16 May 2024 by the Gesellschaft für Klimaschutz München GmbH (GKM GmbH) on the basis of the example product Albion play unit from the eibe unique® product line. eibe Produktion + Vertrieb GmbH & Co KG is liable for the accuracy of the contents. The award criteria of the private-law certification 'Circular Product' of GKM GmbH can be viewed at gesellschaft-klimaschutz.de/zertifizierung/zirkularitaet/.

* The CO₂e emissions of the materials used in the product are taken into account. The emissions that arise during the production process are allocated to the product on a pro-rata basis.

created on: 14 August 2024