

5 67 223 0

Spring rocker Gondola



Age indication



Balance

Scope of delivery

1x frame: stainless steel
2x springs: spring steel

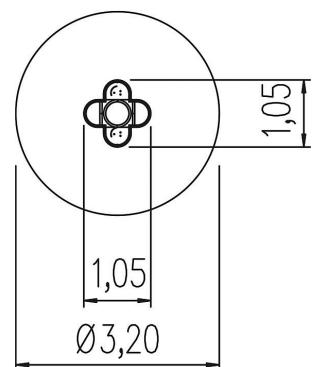
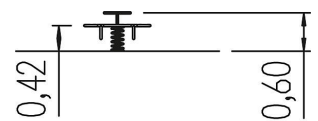





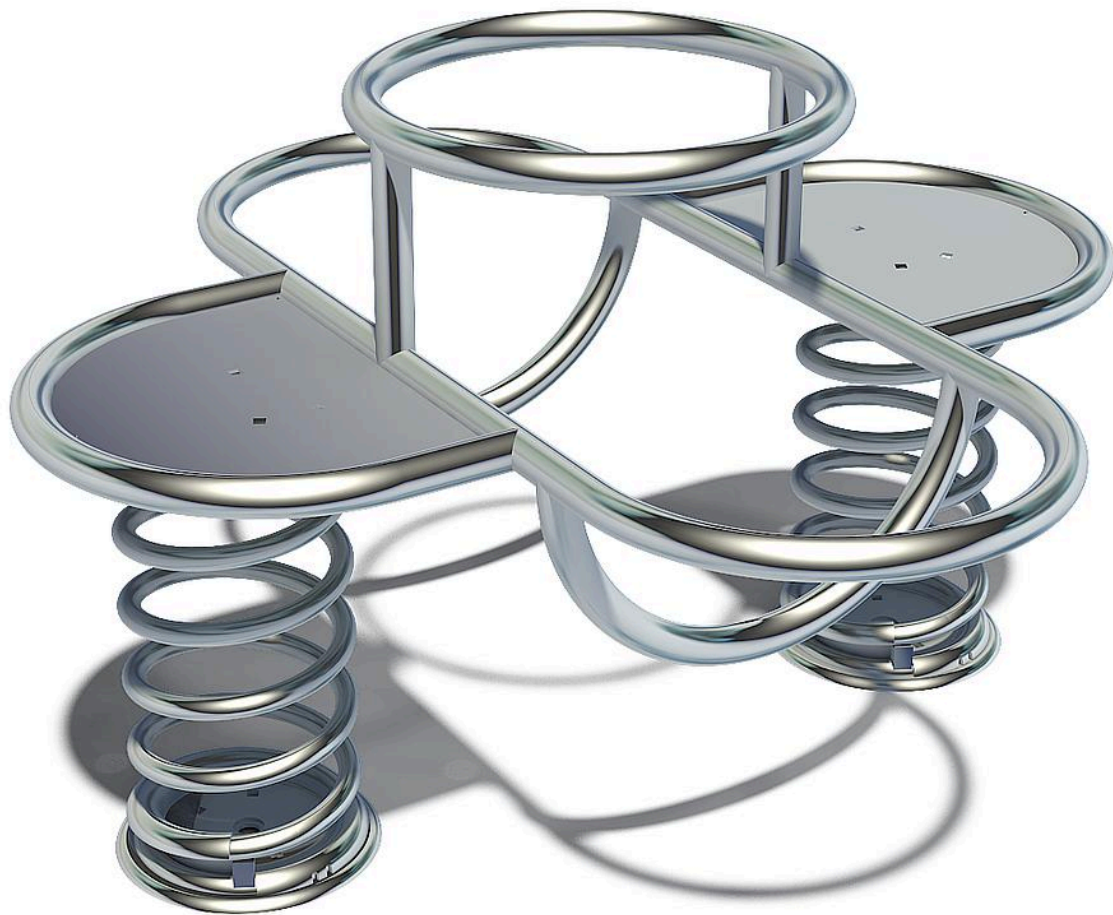





5 67 223 0



Spring rocker Gondola



Technical data

	Material	Stainless steel
	Minimum space	Ø 3,20x2,22 m
	Impact protection net	8,5 m ²
	Free falling height	42 cm
	Ground constitution GE/NL/B	at least lawn
	Ground constitution all except GE/NL/B	at least lawn
	Largest section	113x113x43 cm
	Heaviest section	50 kg
	Certificate	TÜV product service
	Tested according to standard	-

Installation information

	Foundations	2x 5632280 + 1x CF
	Fundamentlevel	ET 480
	Assembly	1 person/1 h



5 67 223 0

Spring rocker Gondola



CO₂ emissions of the product

0 kg

Material share of renewable raw materials

0

Recyclate content

0

Circularity score



Weighted emission factor of the product*



Disclaimer:

This dashboard for the circularity index of the 'Circular Product' certification was generated automatically and is based on the corresponding certification of eibe Produktion + Vertrieb GmbH & Co KG, Industriestraße 1, 97285 Röttingen, which was issued on 16 May 2024 by the Gesellschaft für Klimaschutz München GmbH (GKM GmbH) on the basis of the example product Albion play unit from the eibe unique® product line. eibe Produktion + Vertrieb GmbH & Co KG is liable for the accuracy of the contents. The award criteria of the private-law certification 'Circular Product' of GKM GmbH can be viewed at gesellschaft-klimaschutz.de/zertifizierung/zirkularitaet/.

* The CO₂e emissions of the materials used in the product are taken into account. The emissions that arise during the production process are allocated to the product on a pro-rata basis.

created on: 14 August 2024