

hexagonal unit

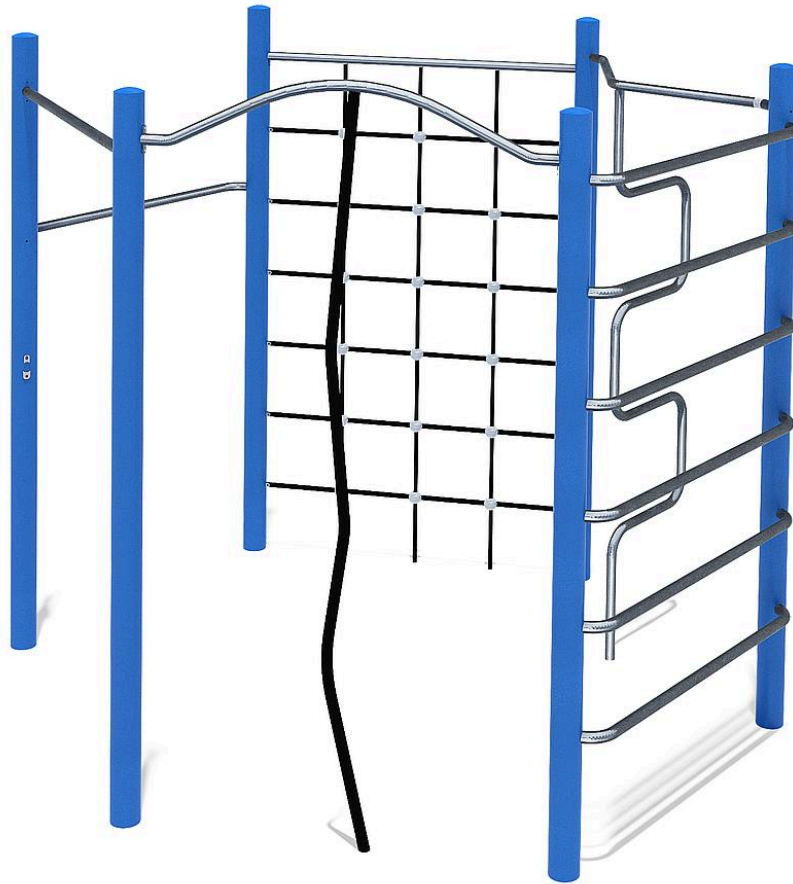

Age indication



Fitness



Balance



Social skills



Senses

Scope of delivery

- 6x posts: steel galvanised and powder-coated
- 1x climbing net: polycoatedsteel cable
- 1x rung element: stainless steel
- 2x horizontal bar: stainless steel
- 1x climbing rope: plastic-coated steel cable
- 1x spiral climbing rod: stainless steel

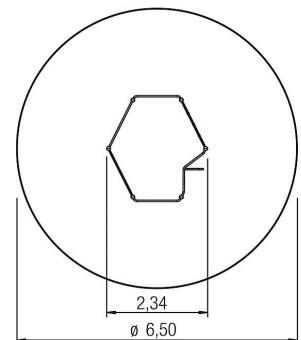
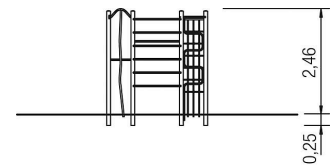



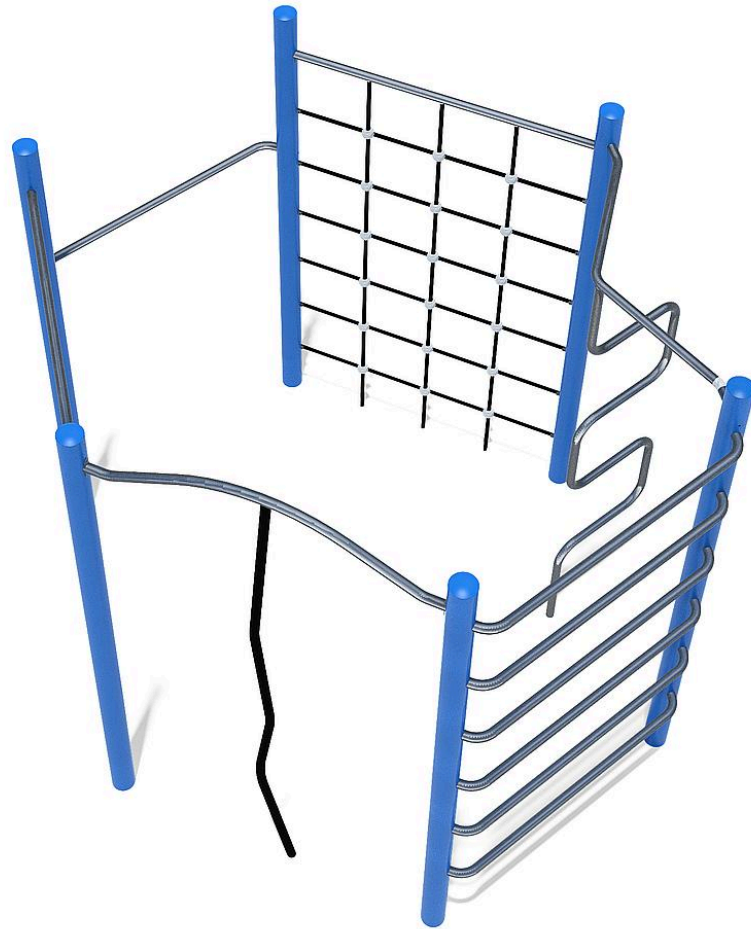







hexagonal unit



Technical data

	Material	powdered steel
	Minimum space	2,75x6,46x4,00 m
	Impact protection net	33,5 m ²
	Free falling height	220 cm
	Ground constitution GE/NL/B	at least sand
	Ground constitution all except GE/NL/B	at least sand
	Largest section	300x120x10 cm
	Heaviest section	80 kg
	Tested according to standard	-
	Service interval (in months)	6

Installation information

	Foundations	8x CF
	Fundamentlevel	ET 900
	Assembly	2 persons/4 h
	PF Accessories	-
	PF drainage	-
	PF concrete	-
	PF excavation	-
	CF Accessories	-
	CF drainage	-
	CF concrete	1,65 m ³
	CF excavation	2,77 m ³