

balancing station Terraserpe



Age indication



Fitness



Balance



Social skills



Senses

Scope of delivery



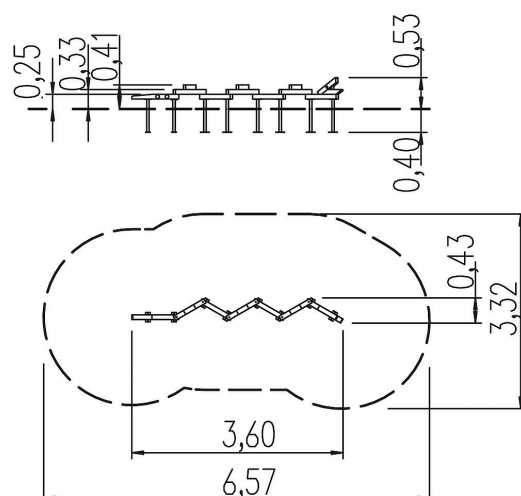



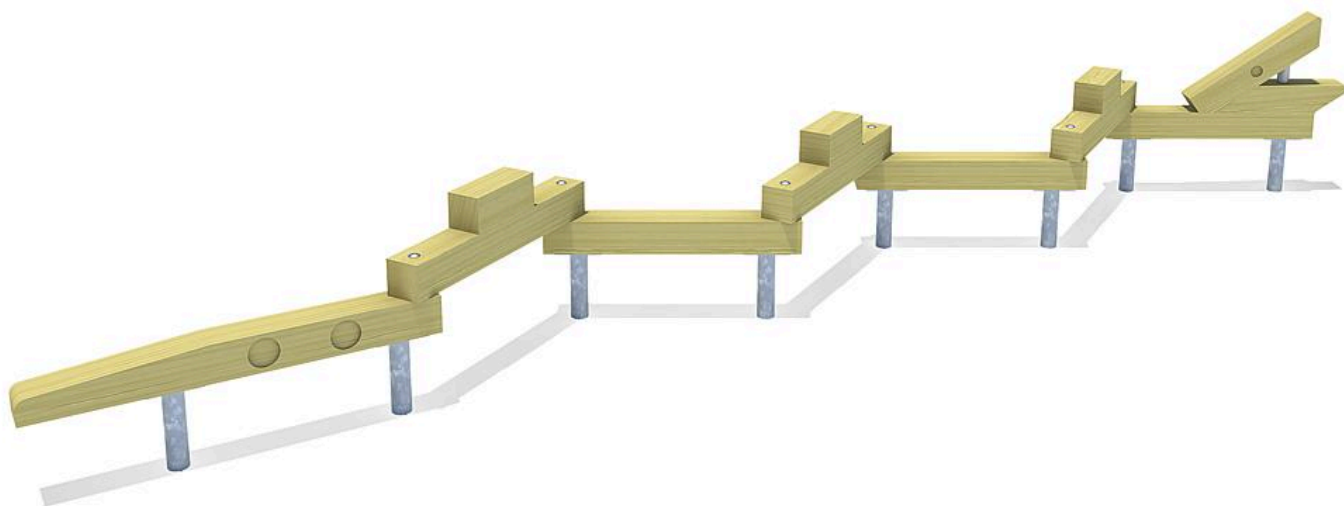



- 1x pre-installed head part: SW
- 3x pre-installed middle parts: SW
- 2x bottom parts: SW
- 1x end part: SW
- 8x post bases: galvanised steel







balancing station Terraserpe



Technical data

	Material	SW pi
	Minimum space	6,57x3,32x2,33 m
	Impact protection net	-
	Free falling height	53 cm
	Ground constitution GE/NL/B	at least stone
	Ground constitution all except GE/NL/B	at least stone
	Largest section	69x36x8 cm
	Heaviest section	5 kg
	Certificate	TÜV product service
	Tested according to standard	-

Installation information

	Foundations	4x CF or 8x PFs
	Fundamentlevel	ET 400
	Assembly	1 person/2 h
	PF Accessories	8x 5632540



5 10 014 011 00

balancing station Terraserpe



CO₂ emissions of the product

177 kg

Material share of renewable raw materials

60%

Recyclate content

37%

Circularity score



Weighted emission factor of the product*



Disclaimer:

This dashboard for the circularity index of the 'Circular Product' certification was generated automatically and is based on the corresponding certification of eibe Produktion + Vertrieb GmbH & Co KG, Industriestraße 1, 97285 Röttingen, which was issued on 16 May 2024 by the Gesellschaft für Klimaschutz München GmbH (GKM GmbH) on the basis of the example product Albion play unit from the eibe unique® product line. eibe Produktion + Vertrieb GmbH & Co KG is liable for the accuracy of the contents. The award criteria of the private-law certification 'Circular Product' of GKM GmbH can be viewed at gesellschaft-klimaschutz.de/zertifizierung/zirkularitaet/.

* The CO₂e emissions of the materials used in the product are taken into account. The emissions that arise during the production process are allocated to the product on a pro-rata basis.

created on: 14 August 2024