

# play unit Monte Viso, solo



Age indication



Speed



Fitness



Social skills



Balance

## Scope of delivery



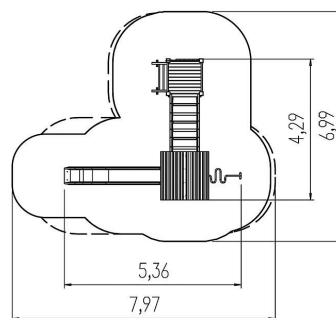
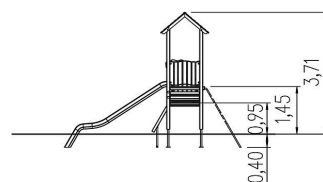







- 8x post construction: softwood or steel
- 8x post shoe: steel galvanised
- 2x platform construction: softwood
- 2x parapet: softwood
- 1x decoration element: high pressure laminate (HPL)
- 2x walk-through protective device: stainless steel
- 2x set of grips: aluminium, plastic coated
- 1x climbing panel: high pressure laminate (HPL)
- 1x ladder: softwood, rungs stainless steel
- 1x slide entry plate: high pressure laminate (HPL)
- 1x saddle roof: softwood
- 1x wobbly bridge sloped: softwood, chain steel galvanised
- 1x wave ladder: stainless steel, softwood
- 1x access restriction: high pressure laminate (HPL)
- fittings: stainless steel













# play unit Monte Viso, solo



## Technical data

|   |   |                     |
|---|---|---------------------|
|  | Material                                  | SW pi               |
|  | Minimum space                             | 7,72x7,00x3,71 m    |
|  | Impact protection net                     | 36,5 m <sup>2</sup> |
|  | Free falling height                       | 145 cm              |
|  | Ground constitution<br>GE/NL/B            | at least turf       |
|  | Ground constitution<br>all except GE/NL/B | at least sand       |
|  | Largest section                           | 0,15x0,15x3,70 m    |
|  | mx. number of users                       | 46                  |
|  | Certificate                               | Z2_010651_514_Rev00 |
|  | Tested according to<br>standard           | EN 1176 - 1/3/7     |

## Installation information

|   |                |                     |
|---|----------------|---------------------|
|  | Foundations    | 11x CF or 11x PFs   |
|  | Fundamentlevel | ET 400              |
|  | Assembly       | 2 persons/10 h      |
|  | PF Accessories | 11x 5632540         |
|  | PF drainage    | -                   |
|  | PF concrete    | -                   |
|  | PF excavation  | 2,50 m <sup>3</sup> |
|  | CF Accessories | 11x 5631120         |
|  | CF drainage    | -                   |
|  | CF concrete    | 0,53 m <sup>3</sup> |
|  | CF excavation  | 1,23 m <sup>3</sup> |

## Accessories

-  Slides for platform heights: 1x 145 cm
- Installation accessories e.g. PF
- Please order accessories separately to complete the appliance.



5 11 503 011 00

# play unit Monte Viso, solo



**CO<sub>2</sub> emissions of the product**

**788,4 kg**

**Material share of renewable raw materials**

**77%**

**Recyclate content**

**14%**

Circularity score



Weighted emission factor of the product\*



**Disclaimer:**

This dashboard for the circularity index of the 'Circular Product' certification was generated automatically and is based on the corresponding certification of eibe Produktion + Vertrieb GmbH & Co KG, Industriestraße 1, 97285 Röttingen, which was issued on 16 May 2024 by the Gesellschaft für Klimaschutz München GmbH (GKM GmbH) on the basis of the example product Albion play unit from the eibe unique® product line. eibe Produktion + Vertrieb GmbH & Co KG is liable for the accuracy of the contents. The award criteria of the private-law certification 'Circular Product' of GKM GmbH can be viewed at [gesellschaft-klimaschutz.de/zertifizierung/zirkularitaet/](https://gesellschaft-klimaschutz.de/zertifizierung/zirkularitaet/).

\* The CO<sub>2</sub>e emissions of the materials used in the product are taken into account. The emissions that arise during the production process are allocated to the product on a pro-rata basis.

created on: 14 August 2024