

# platform with mud tub

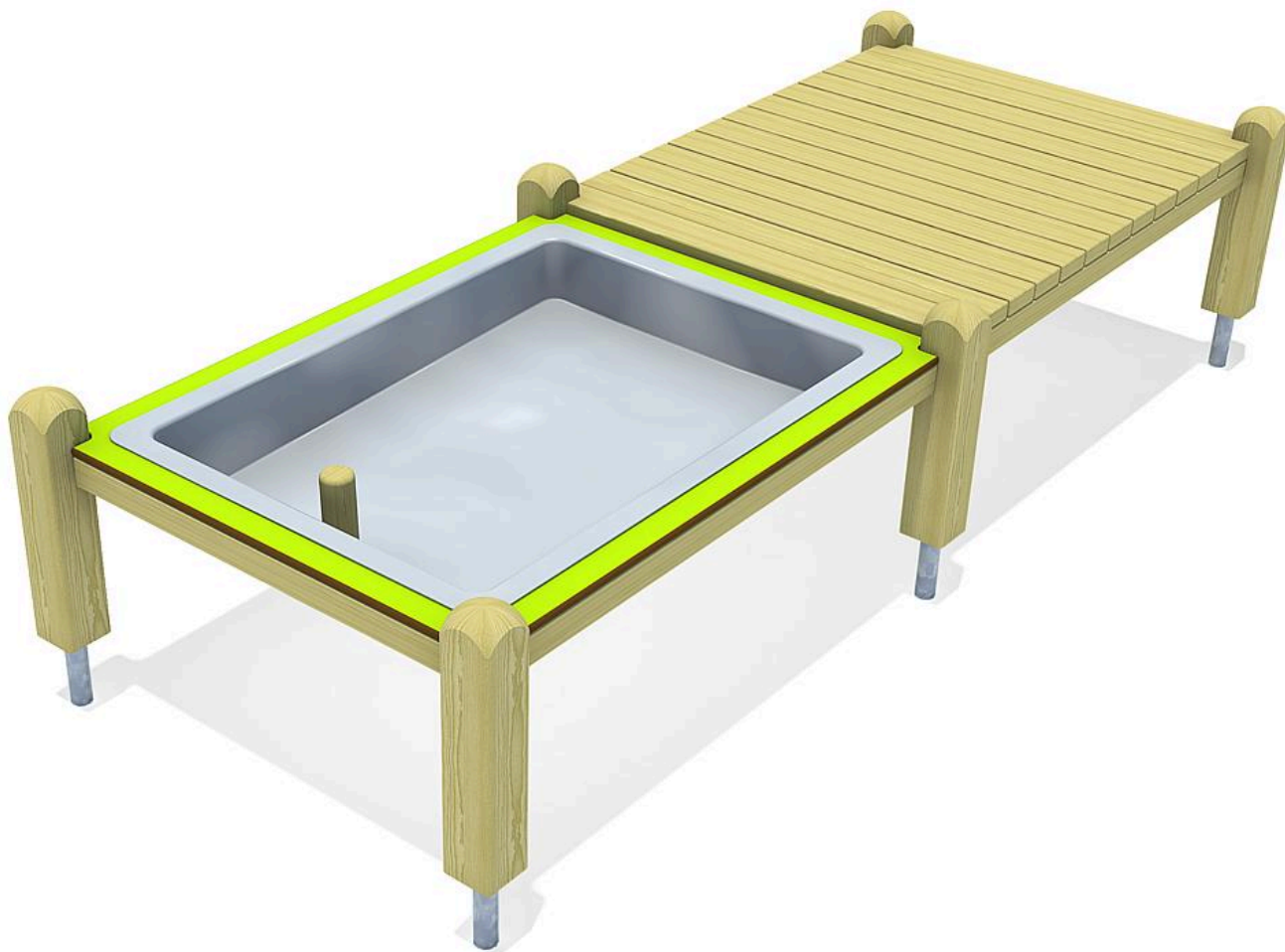

Age indication



Social skills



Experiencing the



Something new to

## Scope of delivery



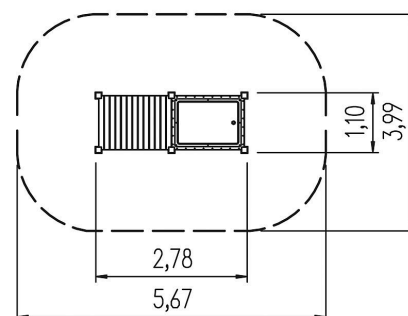
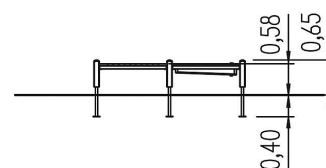



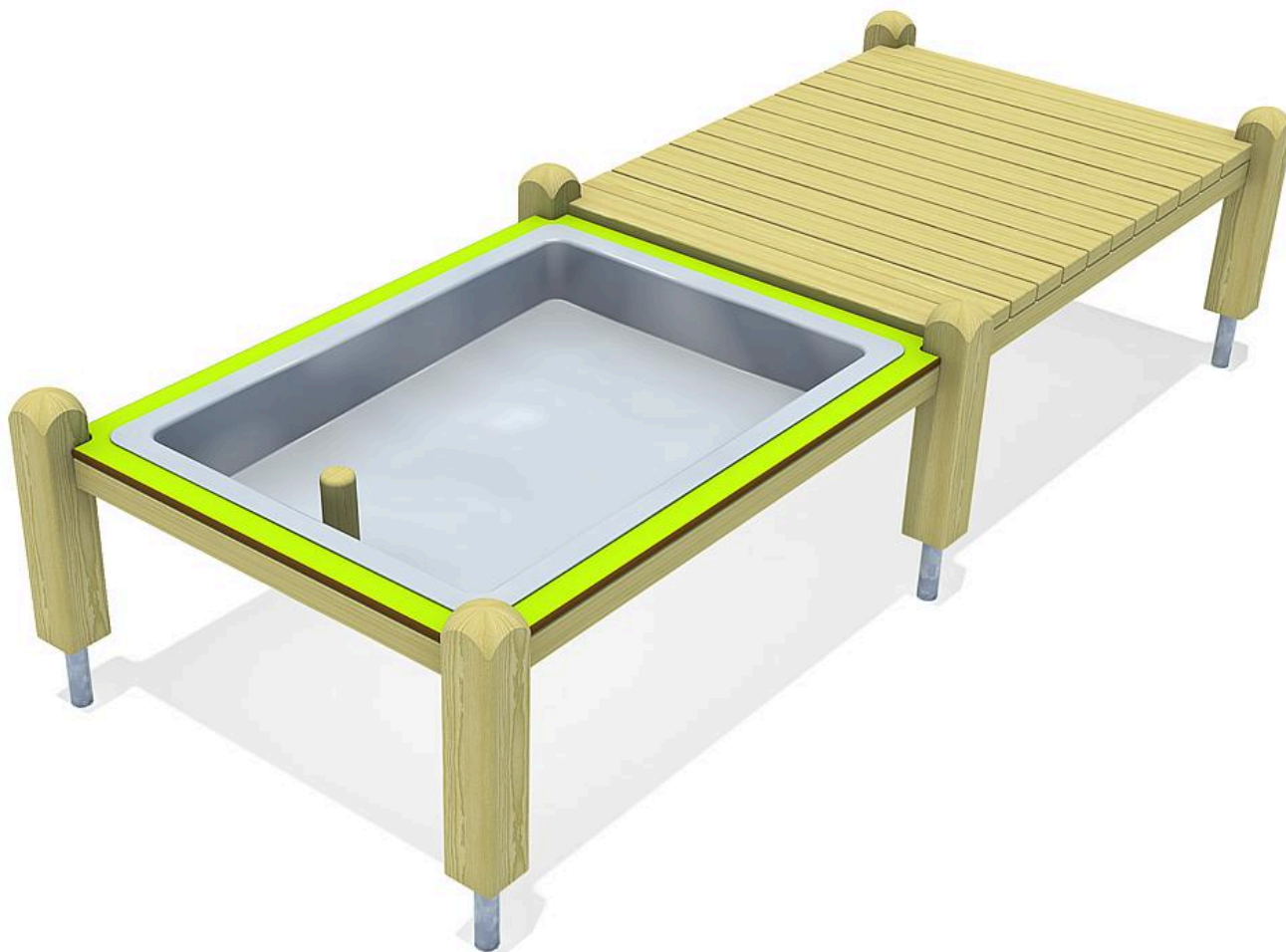

6x post construction: SW  
 6x post shoe: steel galvanised  
 1x platform construction: SW  
 1x aqua-basin: HPL, SW, mud tray plastic  
 fittings: stainless steel  
 designed for the supervised area













# platform with mud tub



## Technical data

	Material	SW pi
	Minimum space	5,68x4,00x2,38 m
	Impact protection net	-
	Free falling height	58 cm
	Ground constitution GE/NL/B	at least stone
	Ground constitution all except GE/NL/B	at least stone
	mx. number of users	8
	Certificate	Z2_010651_0526_Rev00
	Tested according to standard	EN 1176 - 1/7

## Installation information

	Foundations	6x CF or 6x PFs
	Fundamentlevel	ET 400
	Assembly	2 persons/4 h
	PF Accessories	6x 5632540
	PF drainage	-
	PF concrete	-
	PF excavation	0,56 m³
	CF drainage	-
	CF concrete	0,29 m³
	CF excavation	0,67 m³



5 11 043 011 00

# platform with mud tub



**CO<sub>2</sub> emissions of the product**

**375 kg**

**Material share of renewable raw materials**

**60%**

**Recyclate content**

**17%**

Circularity score



Weighted emission factor of the product\*



**Disclaimer:**

This dashboard for the circularity index of the 'Circular Product' certification was generated automatically and is based on the corresponding certification of eibe Produktion + Vertrieb GmbH & Co KG, Industriestraße 1, 97285 Röttingen, which was issued on 16 May 2024 by the Gesellschaft für Klimaschutz München GmbH (GKM GmbH) on the basis of the example product Albion play unit from the eibe unique® product line. eibe Produktion + Vertrieb GmbH & Co KG is liable for the accuracy of the contents. The award criteria of the private-law certification 'Circular Product' of GKM GmbH can be viewed at [gesellschaft-klimaschutz.de/zertifizierung/zirkularitaet/](https://gesellschaft-klimaschutz.de/zertifizierung/zirkularitaet/).

\* The CO<sub>2</sub>e emissions of the materials used in the product are taken into account. The emissions that arise during the production process are allocated to the product on a pro-rata basis.

created on: 14 August 2024