



0.5+



19



0,6m



1 = 3,43m  
2 = 2,93m  
3 = 2,12m



Physical inclusion  
Sensory inclusion  
Cognitive inclusion

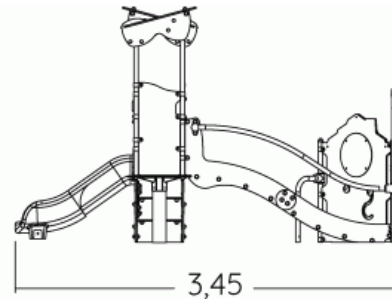
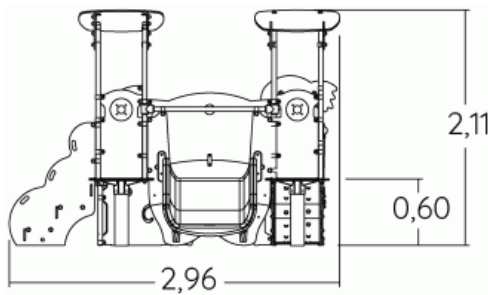

Play value : **23**

role play



x1

sliding



x1

meeting



x1

handling



x4

crawling



x3

hiding



x1

taking shelter



x2

tactile stimulation



x4

visual stimulation



x2

climbing



x2



getting across





x2

## Installation of equipment

**IMPORTANT:** It is essential to refer to the installation instructions for information on the size of the safety areas.

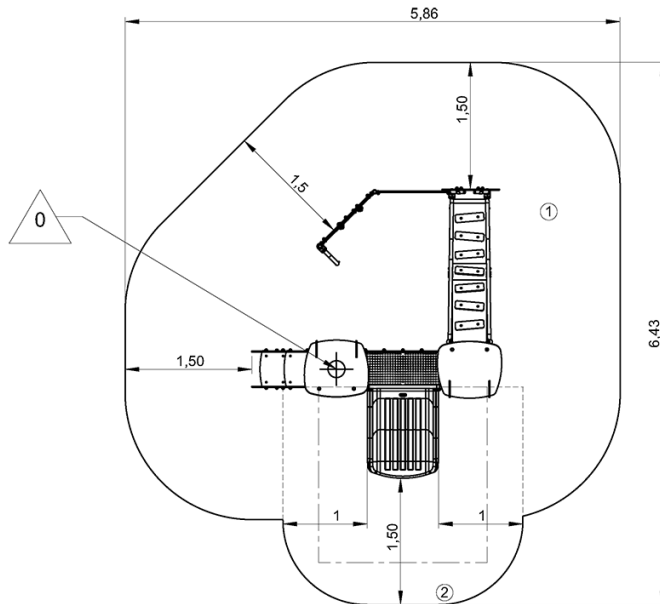
-  Impact area (minimum normative surface)
-  Free space



		
1	0,6m	23,5m <sup>2</sup>
2	1m	7m <sup>2</sup>



2



08h00



0.36m<sup>3</sup>



30.5m<sup>2</sup>



336kg



54kg

