















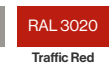

Standard Unit Dimensions:

Width: 4848mm
Height: 3177mm to Centre

Length with Capacities:

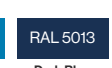
5000mm (24 Cycles)

Colours/Finishes:

		
Galvanised Only	White Aluminium	Anthracite Grey
		
BS 4800 10 A 07 Nimbus Grey	Traffic Red	Jet Black
		
BS 4800 14 C 39 Holly Green	Traffic Yellow	Goose Grey
		
RAL 5015 Mid Blue	Dark Blue	Traffic White
		
BS 4800 20 C 40 Midnight Blue	Dark Admiralty Grey	Moss Green

The colours shown are a guide only.
Please check a colour chart to see the actual colour.

Product Information

The Cambridge Cycle Shelter offers a stunning feature shelter with the practicality of being able to accommodate 24 cycles under one unit. Modular in design the Cambridge Cycle Shelter can be linked to form banks of shelters to accommodate large quantities of cycles with access from both sides of the shelter.

Features

- Robust modular construction featuring load bearing purlins and glazed bar system
- Heavy-duty circular uprights and box section purlins and trimmers, assembled with anti-tamper high strength bolts
- Anti-climb end frames
- Submerged baseplates
- Accessible from both sides
- Hot dipped galvanized to BS EN ISO 1461:2022
- 5mm Clear View PETg UV Roof Cladding
- Breacam Compliant Configurations

Materials Used

- Framework - Mild Steel
- Cladding - 4 mm PETG uv
- Fasteners - Zinc Plated
- Cover Strips - Pre-galvanized steel flat

Broxap Limited, Rowhurst Industrial Estate, Chesterton, Newcastle-under-Lyme, Staffordshire, ST5 6BD T: 01782 564411 E: info@broxap.com W: www.broxap.com



Cambridge Cycle Shelter BXMW/CA/1

Finish Options

- Galvanised to BS EN ISO 1461:2022
- Galvanised to BS EN ISO 1461:2022 & Polyester Powder Coated

Weather Resistance

Cladding is UV Stabilised
Wind resistant to 23m/s

Fire Resistance

Cladding is fire tested to '1Y' for BS 476

Guarantees, Warranties, Design-Life and Life-Expectancies

- 25 year structural guarantee*
- 34 year (min) life expectancy for Hot Dip Galvanizing
- 8-10 year life expectancy on standard powder coatings
- 10-15 year life expectancy on Duplex (Zinc Coated) powder coatings
- 10 years' manufacturers guarantees* on cladding material(s)
- 10 years' warranty* on material (only)
- 12 months' warranty* on parts & labour

*Maintenance and other qualifying criteria apply

Options

- Trapezoidal Roof Cladding
- Opal Roof Cladding
- Powder Coating to a wide range of colours
- LED or solar lighting
- Multiple Banks to Increase Cycle Capacity
- Full Installation Service

Diagram

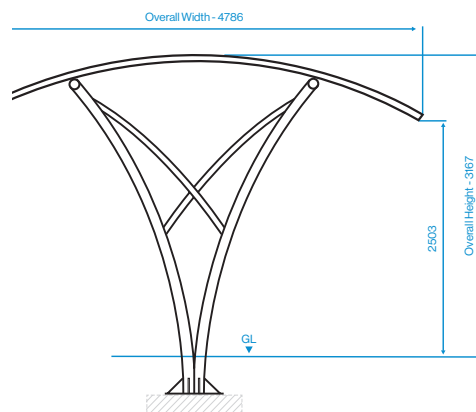

Installation

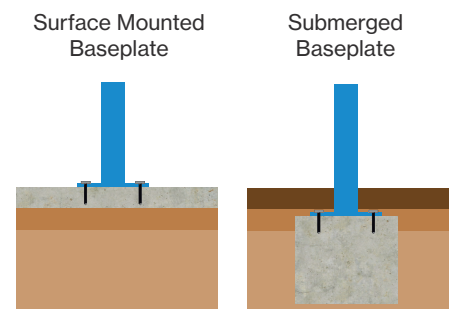

Standard Unit Dimensions:

Width: 4848mm

Height: 3177mm to Centre

Length with Capacities:

5000mm (24 Cycles)

Colours/Finishes:

Galvanised Only	RAL 9006 White Aluminium	RAL 7016 Anthracite Grey
BS 4800 10 A 07 Nimbus Grey	RAL 3020 Traffic Red	RAL 9005 Jet Black
BS 4800 14 C 39 Holly Green	RAL 1023 Traffic Yellow	BS 4800 00 A 05 Goose Grey
RAL 5015 Mid Blue	RAL 5013 Dark Blue	RAL 9016 Traffic White
BS 4800 20 C 40 Midnight Blue	BS 4800 18 B 25 Dark Admiralty Grey	RAL 6005 Moss Green

The colours shown are a guide only.
Please check a colour chart to see the actual colour.

Broxap Limited, Rowhurst Industrial Estate, Chesterton, Newcastle-under-Lyme, Staffordshire, ST5 6BD T: 01782 564411 E: info@broxap.com W: www.broxap.com

