









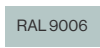

## Lanarkshire Planter BX45 4000

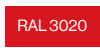

### Standard Unit Dimensions:

Length: 1000mm  
Width: 1000mm  
Height: 750mm  
Weight: 95kg

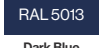
### Planter Colours/Finishes:

 Galvanised Only Finish	 RAL 9006 White Aluminium	 RAL 7016 Anthracite Grey
 BS 4800 10 A 07 Nimbus Grey	 RAL 3020 Traffic Red	 RAL 9005 Jet Black
 BS 4800 14 C 39 Holly Green	 RAL 1023 Traffic Yellow	 BS 4800 00 A 05 Goose Grey
 RAL 5015 Mid Blue	 RAL 5013 Dark Blue	 RAL 9016 Traffic White

The colours shown are a guide only.  
Please check a colour chart to see the  
actual colour.

### Product Information

The Lanarkshire Planter is a large capacity steel planter in 3mm galvanised steel, with single galvanised steel liner and two gold alloy bands as standard.

### Features

- Additional option to powder coat in an RAL or BS colour
- Free standing

### Materials Used

- Galvanised steel

### Options

- Can be customised to create special public or corporate identity through the addition of logos, crests, coats of arms, lettering, dates or other unique elements
- Laser cut logos, lettering, etc with an anodised aluminium backing plate

Broxap Limited, Rowhurst Industrial Estate, Chesterton, Newcastle-under-Lyme, Staffordshire, ST5 6BD T: 01782 564411 E: info@broxap.com W: www.broxap.com



**Diagram**

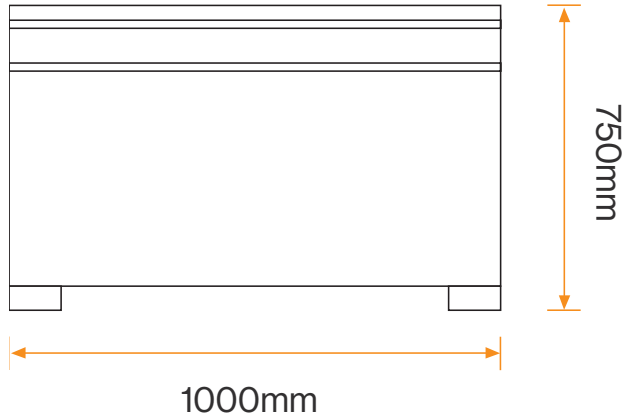

**Installation**

Free Standing  
 Planter



**Standard Unit Dimensions:**

Length: 1000mm  
 Width: 1000mm  
 Height: 750mm  
 Weight: 95kg

**Planter  
 Colours/Finishes:**

Galvanised Only Finish	White Aluminium	Anthracite Grey
Nimbus Grey	Traffic Red	Jet Black
Holly Green	Traffic Yellow	Goose Grey
Mid Blue	Dark Blue	Traffic White

The colours shown are a guide only.  
 Please check a colour chart to see the actual colour.

Broxap Limited, Rowhurst Industrial Estate, Chesterton, Newcastle-under-Lyme, Staffordshire, ST5 6BD T: 01782 564411 E: info@broxap.com W: www.broxap.com

