

Installation Instructions

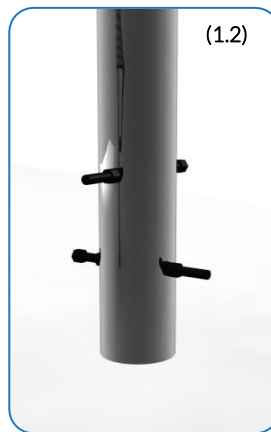
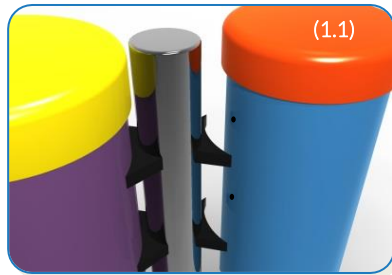

1. Attach the steel leg to each of the congas with the M10x50 security screws, square washers and PU mounts. (1.1) (See Assembly Guide)

2. Attach Ground Fixings to legs. (1.2) (See Ground Fix Post Installation Sheet)

3. Excavate 1 hole for the Steel leg 250mm diameter by 300mm deep, in desired location upon decision from customer.

4. Locate (lower) legs into hole making sure they are vertical and level prior to concreting in place.

5. Once happy with location of the Instrument, fill hole using rapid hardening concrete. Be sure to compact concrete around legs and leave to dry according to manufactures guidelines.

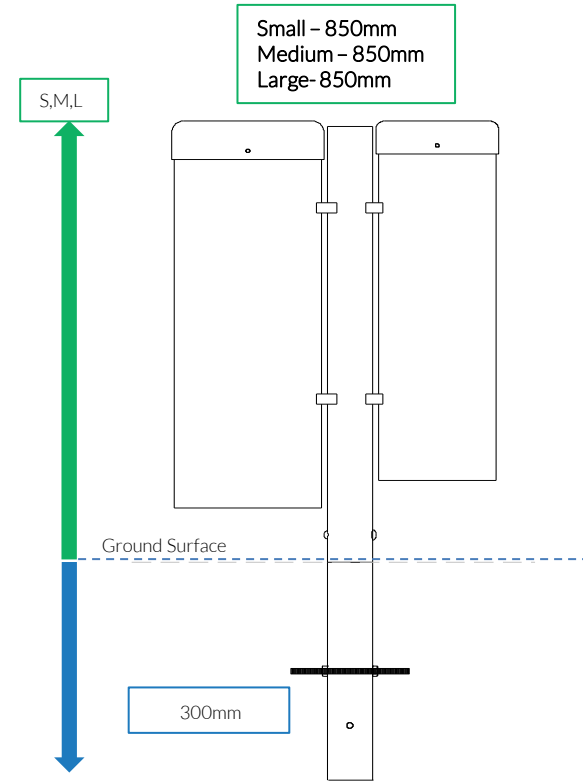
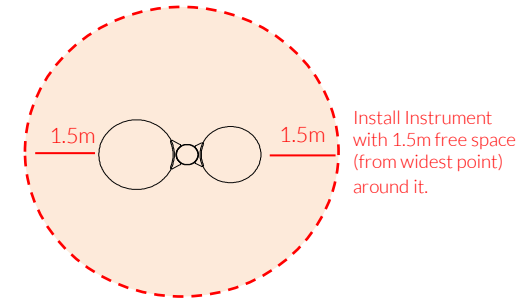

Weight of heaviest part 3.8kg (Large drum Small Congas)
Weight of heaviest part 4.5kg (Large drum Medium Congas)
Weight of heaviest part 5.2kg (Large drum Large Congas)

Ground Fixed

Congas
Page 1 of 3



Instrument Components:

- x4
- M10x50 Security Screw
- x4
- M10x50x3 Square washer
- x2
- PU 200 Mount
- x2
- PU 250 Mount

Metric Conversion:
250mm/ 10"
400mm/ 16"
850mm/ 33"
1.5m/ 59"



Ground Fix Components:

- x2
- M10x200 Threaded Bar
- x4
- M10 Nut



Spares available from percussionplay.com or from your local distributor

14.8 Kg
15 Kg
20 Kg

Assembly Guide PPCONG

Tools:

 x1
TX 45 Driver Bit

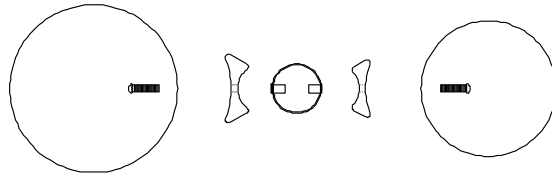

PPCONG PLAN

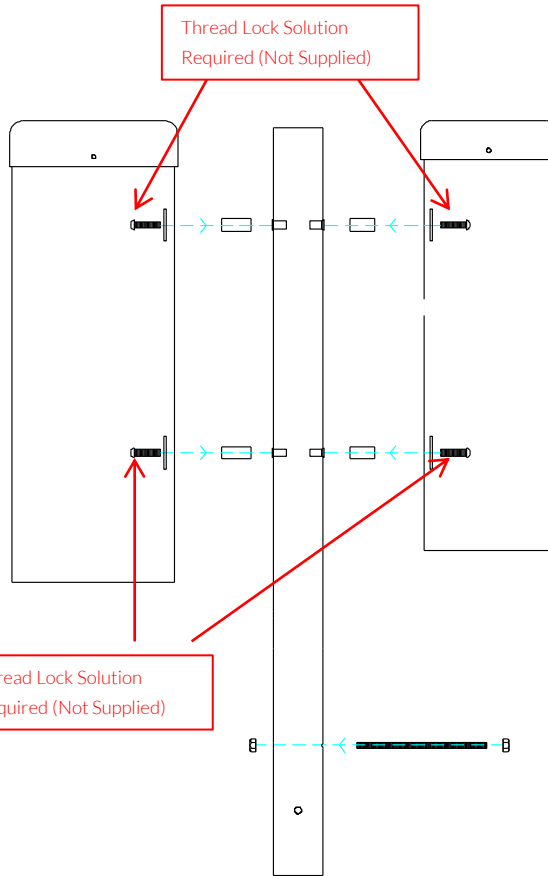



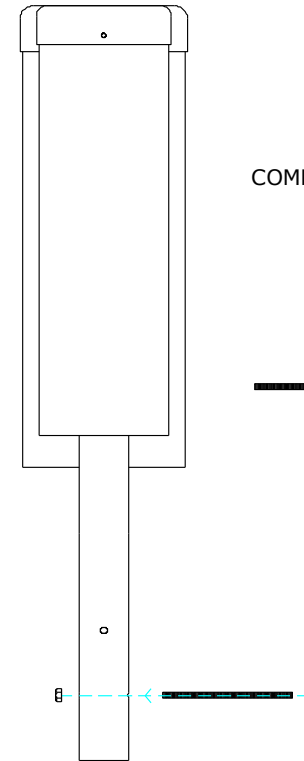



PPCONG FRONT



PPCONG SIDE

COMPONENTS LIST:





-  M10x50 Pin torx X4
-  M10x50x3 square washer X4
-  M10 Nut X4
-  M10x200 Threaded Bar X2
-  PU MOUNT 200 X2
-  PU MOUNT 250 X2

Ground Fixed

Congas
Page 2 of 3



Instrument Components:

-  x4
M10x50 Security Screw
-  x4
M10x50x3 Square washer
-  x2
PU 200 Mount
-  x2
PU 250 Mount

Thread Lock Solution
Required (Not Supplied)



Ground Fix
Components:

-  x2
M10x200 Threaded Bar
-  x4
M10 Nut



Spares available from
percussionplay.com or from your
local distributor

14.8 Kg
15 Kg
20 Kg

Ground Fix Post Installation

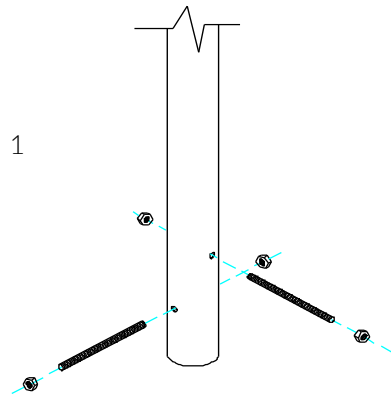

1
Insert M10x 200 Threaded bar into pre drilled holes in Ground Fixing Post

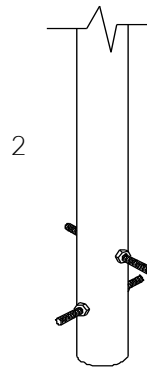

2
Fix M10x 200 Threaded bar in place using M10 Nuts

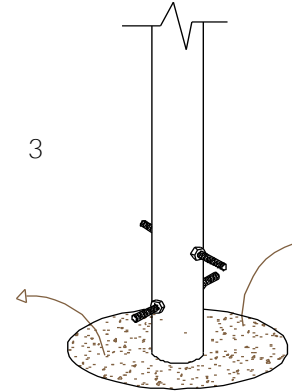

3
Excavate a hole with a 250mm diameter tapering down to 350mm diameter and 350mm depth

Foundations should not present a hazard. These foundations are recommended as a guide, for more information on foundation details for various surface see Part 1 of BS EN 1176.

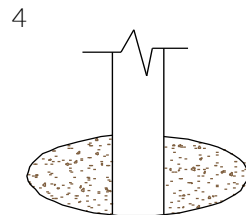

4
Compact base of hole with 50mm of aggregate. Lower ground Fix post attached of instrument into hole (check instrument straight and level before filling with concrete)

300mm min depth

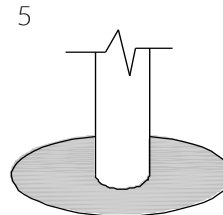

5
Fill hole with fast drying concrete to manufacturers specifications.

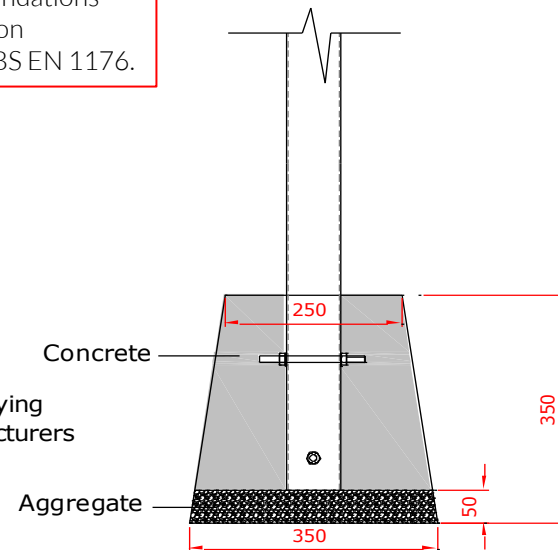

Ground Fixed

Congas
Page 3 of 3



Components:

-  x2
- M10x200 Bolt
-  x4
- M10 Nut

Metric Conversion:
50mm/ 2"
250mm/ 10"
350mm/ 14"
400mm/ 16"
450mm/ 18"



Installation Instructions



1. Attach the steel leg to each of the congas with the M10x50 security screws, square washers and PU mounts. (1.1) (See Assembly Guide)

2. Attach Frost Extension to legs (1.2) (See Ground Fix Post Installation Sheet)

3. Excavate 1 hole for the Steel leg 250mm diameter by 900mm deep, in desired location upon decision from customer.

4. Locate (lower) legs into hole making sure they are vertical and level prior to concreting in place.

5. Once happy with location of the Instrument, fill hole using rapid hardening concrete. Be sure to compact concrete around legs and leave to dry according to manufactures guidelines.

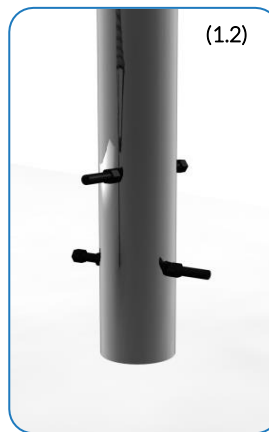
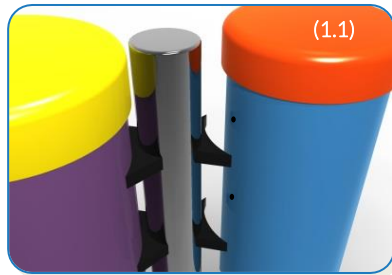
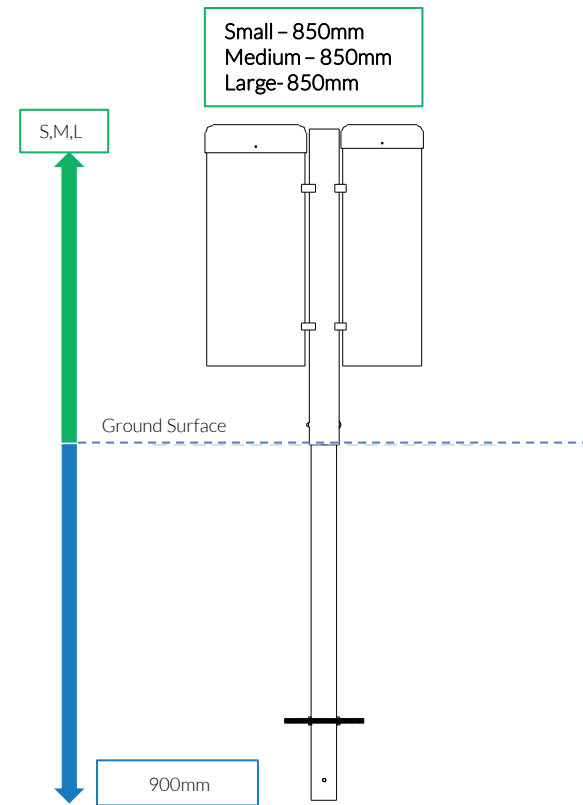
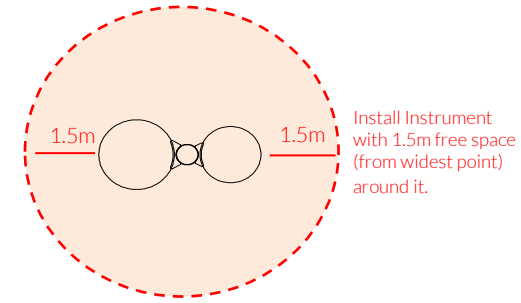

Weight of heaviest part 3.8kg (Large drum Small Congas)
 Weight of heaviest part 4.5kg (Large drum Medium Congas)
 Weight of heaviest part 5.2kg (Large drum Large Congas)

Frost Extension

Congas
Page 1 of 3



Instrument Components:

- x4
- x4
- x2
- x2

Metric Conversion:
 250mm/ 10"
 850mm/ 33"
 900mm/ 35 7/16"
 1.5m/ 59"



Ground Fix Components:

- x2
- x4
- x1
- x1



Spares available from percussionplay.com or from your local distributor

14.8 Kg
15 Kg
20 Kg