

Installation Instructions

Ground Fixed

Akadinda
Page 1 of 2



1. Assemble Akadinda frame comprising 2x 'X'-shaped legs and 1x horizontal beam. (See **Assembly Guide**). Cover 8 holes on horizontal beam using **4x30mm caps** (1.1)



2. Locate M8x80mm eye bolts through pre drilled holes using flat washers on both sides of the timber to prevent the fixing pulling into the timber. Secure in place with **M8 nyloc nuts**, cover 4 holes in ends using **4x30mm caps**. (1.3)



3. Place Akadinda in desired location and mark 4 holes for excavation.

4. Excavate holes to min depth **150mm** according to required height for intended players. Hole depth guide below.

5. Locate legs in holes and check levels prior to concreting in place. Once happy with location and levels, **fill holes using rapid hardening concrete**. Leave to dry according to manufactures guidelines.

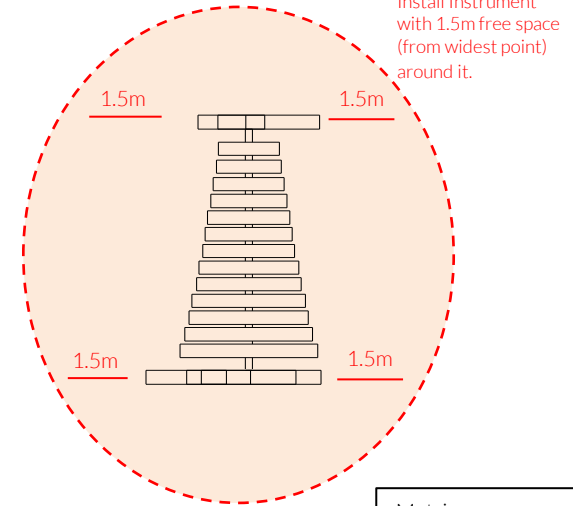

Install Instrument with 1.5m free space (from widest point) around it.

Metric Conversion:	
150mm/ 6"	
250mm/ 10"	
360mm/ 14"	
400mm/ 16"	
500mm/ 20"	
650mm/ 26"	
750mm/ 30"	
900mm/ 35"	
1.5m/ 59"	

Height to centre of notes:
KS0 3-5 500mm Depth 400mm
KS1 5-7 650mm Depth 250mm
KS2 7-11 750mm Depth 150mm
Adult 900mm Surface Mounted

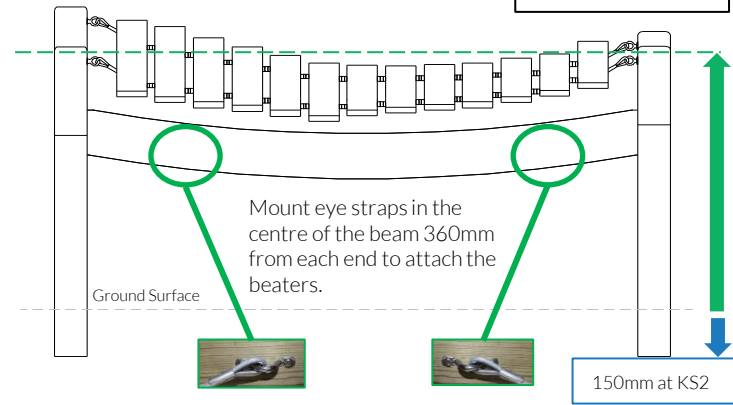

Weight of heaviest part **28kg** (Frame)

Instrument Components:

- M10 Wedge Nut X2
- M10x30 SS Washer X2
- M8x25 SS Washer X8
- Eye Straps X2
- M8 Lock Nut X4
- 10x38mm Secure Screw X4
- M10x130 Bolt X2
- 5x70mm Screw X4
- Black Caps X8



Pair Large Red Beaters X2



Spares available from percussionplay.com or from your local distributor

48 Kg

Assembly Guide PPAKAD





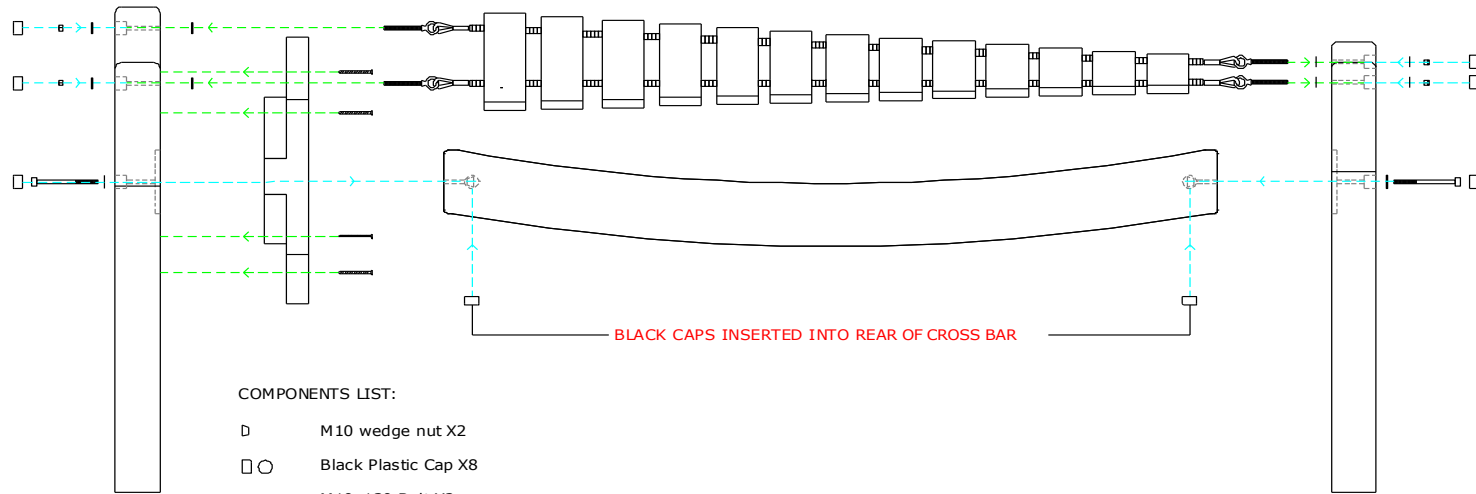

Tools:



x1
TX 25 Driver Bit



COMPONENTS LIST:

-  M10 wedge nut X2
-  Black Plastic Cap X8
-  M10x130 Bolt X2
-  M10x30 washer X2
-  M8x25 washer X8
-  5x70 screw X4
-  M8 Nyloc nut X4

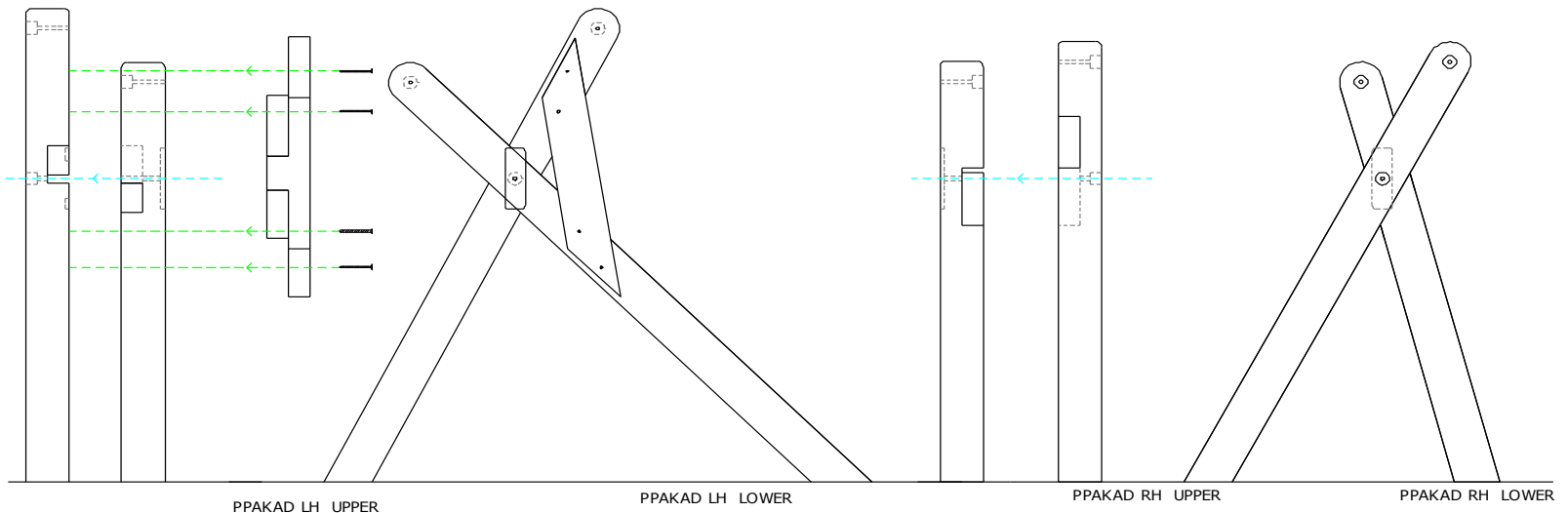

Ground Fixed
Akadinda
Page 2 of 2

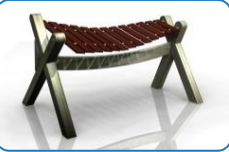

Instrument Components:

-  M10 Wedge Nut X2
-  M10x30 SS Washer X2
-  M8x25 SS Washer X8
-  Eye Straps X2
-  M8 Lock Nut X4
-  5x40mm Secure Screw X4
-  M10x130 Bolt X2
-  5x70mm Screw X4
-  Black Caps X8



Pair Large Red Beaters X2

Spares available from percussionplay.com or from your local distributor

48 Kg