











Standard Unit Dimensions:

Width: 4200mm
Height to Lower Eaves: 2675mm
Height to Ridge: 3211mm

Length with Capacities:

3600mm (16 Cycles)
4100mm (20 Cycles)
5000mm (24 Cycles)

Colours/Finishes:

 Galvanised Only	 RAL 9006 White Aluminium	 RAL 7016 Anthracite Grey
 BS 4800 10 A 07 Nimbus Grey	 RAL 3020 Traffic Red	 RAL 9005 Jet Black
 BS 4800 14 C 39 Holly Green	 RAL 1023 Traffic Yellow	 BS 4800 00 A 05 Goose Grey
 RAL 5015 Mid Blue	 RAL 5013 Dark Blue	 RAL 9016 Traffic White

The colours shown are a guide only.
Please check a colour chart to see the actual colour.

Product Information

The versatility of the Cambridge Hybrid cycle shelter means that the shelter can be retro-fitted with extensions at a later date pushing the parking capacity upwards whilst keeping installation costs low.

Features

- Robust Modular Construction Featuring Tubular End Frames
- Heavy-Duty Circular Uprights and Box Section Purlins and Trimmers, Assembled with Anti-Tamper High Strength Bolts
- Anti-Climb End Frames
- Surface Mounted Baseplates
- Hot Dipped Galvanized to BS EN ISO 1461:2009
- 4mm Clear View PETg UV Roof Cladding
- Bream Compliant Configurations

Materials Used

- Framework - Mild Steel
- Cladding - 4mm PETg UV
- Fasteners - Zinc Plated
- Cover Strips - Pre-galvanized steel flat

Broxap Limited, Rowhurst Industrial Estate, Chesterton, Newcastle-under-Lyme, Staffordshire, ST5 6BD T: 01782 564411 E: info@broxap.com W: www.broxap.com



Finish Options

- Galvanised to BS EN ISO 1461:2009
- Galvanised to BS EN ISO 1461:2009 & Polyester Powder Coated

Weather Resistance

Cladding is UV Stabilised
Wind resistant to 23m/s

Fire Resistance

Cladding is fire tested to EN ISO 11925-2

Guarantees, Warranties, Design-Life and Life-Expectancies

- 25 year structural guarantee*
- 34 year (min) life expectancy for Hot Dip Galvanizing
- 8-10 year life expectancy on standard powder coatings
- 10-15 year life expectancy on Duplex (Zinc Coated) powder coatings
- 10 years' manufacturers guarantees* on cladding material(s)
- 10 years' warranty* on material (only)
- 12 months' warranty* on parts & labour

*Maintenance and other qualifying criteria apply

Options

- Steel Profile, Trapezoidal Roof Cladding
- Powder coating to a wide range of colours
- LED or Solar Lighting
- Full Installation Service

Diagram

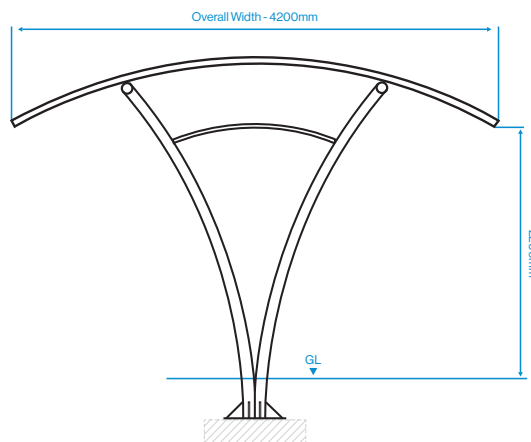

Installation

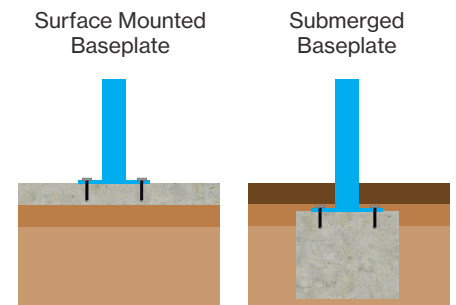

Standard Unit Dimensions:

Width: 4200mm
Height to Lower Eaves: 2200mm

Length with Capacities:

3600mm (16 Cycles)
4100mm (20 Cycles)
5000mm (24 Cycles)

Colours/Finishes:

Galvanised Only	RAL 9006 White Aluminium	RAL 7016 Anthracite Grey
BS 4800 10 A 07 Nimbus Grey	RAL 3020 Traffic Red	RAL 9005 Jet Black
BS 4800 14 C 39 Holly Green	RAL 1023 Traffic Yellow	BS 4800 00 A 05 Goose Grey
RAL 5015 Mid Blue	RAL 5013 Dark Blue	RAL 9016 Traffic White

The colours shown are a guide only.
Please check a colour chart to see the actual colour.

Broxap Limited, Rowhurst Industrial Estate, Chesterton, Newcastle-under-Lyme, Staffordshire, ST5 6BD T: 01782 564411 E: info@broxap.com W: www.broxap.com

