

 **6+**  
 **2**  
 **1,3m**  

 1 = 2,75m  
 2 = 0,4m  
 3 = 1,57m



Motor inclusion  
Sensory inclusion  
Mental inclusion

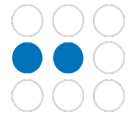
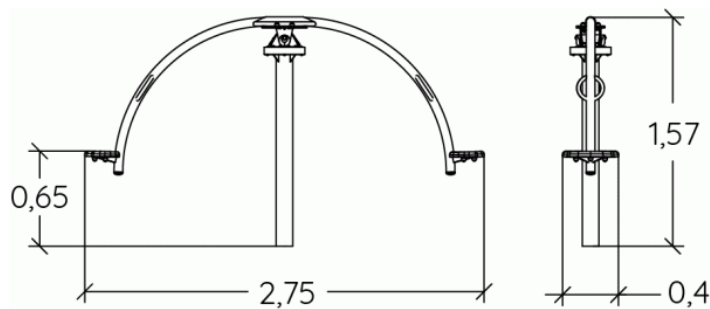

If installed onto wetpour safer surfacing, we recommend a NON-FINES CONCRETE BASE.



**Play value :**

**4**

meeting



x1

swinging



x1

balancing



x1



rotating



x1



## Installation of equipment

**IMPORTANT:** It is essential to refer to the installation instructions for information on the size of the safety areas.

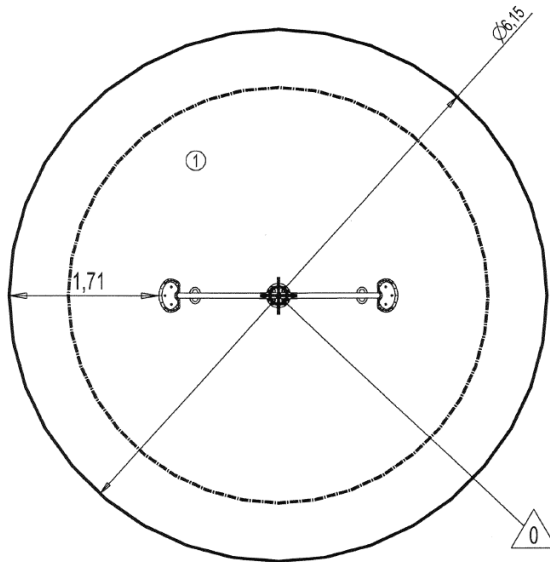
-  Impact area (minimum normative surface)
-  Free space



Point de Référence  
Setting Out Point  
Punto de referencia  
Bezugspunkt  
Referentiepunt

		
1	1,30m	30m <sup>2</sup>



2



03h00



0.3m<sup>3</sup>



30m<sup>2</sup>



101kg



37kg

