

*Safe and sustainable
spaces with*
BAMBOO DECKING





Bamboo: the fastest growing plant in the world



MOSO® BAMBOO X-TREME®
 certified 100% proven
 durable - stable - sustainable

| | | |
|--------------------|------------------|---|
| | Certified | Proven |
| Durable | | Since 2008 over 5 million m² installed, in more than 60 countries. |
| Fire rated | | |
| Sustainable | | |



*high stability:
end-match system*

MOSO[®] Bamboo and Gripsure

With Bamboo X-treme[®], MOSO[®] has developed a truly **ecological** and **durable** alternative to increasingly scarce tropical hardwood and non-renewable materials. MOSO[®] uses a **unique** Thermo-Density[®] **process** of heat-treatment at 200°C followed by High Density[®] compression to enhance the **hardness, dimensional stability, fire resistance** and **durability** to a level **superior** to the best tropical hardwood species. MOSO[®] Bamboo X-treme[®] can be used for **outdoor decking, cladding, fencing and outdoor furniture**.

Gripsure, the UK's exclusive distributor of MOSO[®] Bamboo, are excited to introduce MOSO[®] Bamboo with Gripsure, a sustainable non-slip decking solution that offers an attractive finish to both commercial and residential projects, whilst keeping you safe on your feet all year round.

Table of contents

| | |
|--|----|
| From bamboo to MOSO [®] Bamboo | 4 |
| Discover the Bamboo benefits | 5 |
| MOSO [®] Bamboo decking range | 7 |
| MOSO [®] Bamboo with Gripsure decking range | 9 |
| MOSO [®] Bamboo accessories | 10 |
| MOSO [®] Bamboo installation instructions | 12 |
| MOSO [®] Bamboo maintenance & cleaning | 14 |
| MOSO [®] Bamboo vs. tropical hardwoods | 16 |
| MOSO [®] Bamboo test results | 18 |
| The sustainability of MOSO [®] Bamboo | 20 |
| MOSO [®] Bamboo user information | 22 |

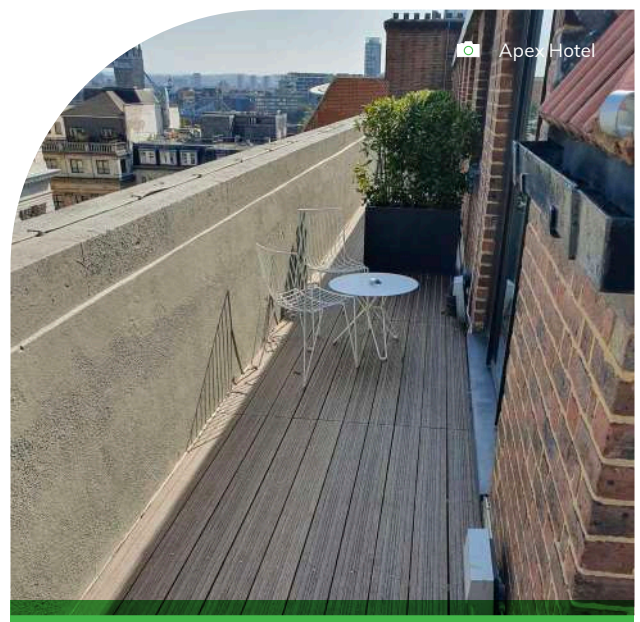

Apex Hotel
Tower Bridge, London

From bamboo to MOSO® Bamboo

Moso bamboo is one of the fastest growing plants on earth. The bamboo stems grow from an underground root system and after 4-5 years a stem can be harvested, while the others continue to grow. This means the bamboo can be used without destroying the forest. The fast growth and abundant availability makes bamboo a rapidly renewable resource, and a perfect material for many applications in and around buildings. With good reason, it's often called **'the building material of the future'**. However, bamboo as a raw material cannot be used outdoors without a protective treatment. Due to its high "sugar"-components, bamboo is more susceptible to being attacked by micro-organisms and fungi. Let us explain how we get from the raw bamboo material to the final product, MOSO® Bamboo X-treme®, through a production process called Thermo-Density®.

Stem to strands

After harvesting, the mature bamboo stems are split in a longitudinal direction and the outer and inner skins are removed. The strips are then crushed using a number of incision rollers which create cross linked strands. The untreated strands are a light yellow colour.

Thermal treatment

In several steps, the strands are heated up to 200°C in the presence of saturated steam (to protect the wood from charring or burning) and cooled down. During thermal processing, the moisture content changes and the sugar content is removed from the material. Furthermore, this process changes the colour of the bamboo from white/yellow to deep/dark brown.

From strands to product

The dark bamboo strands are dipped into phenolic glue (< 10% of the weight of the bamboo). After drying, the strands are put into a mould, and are then compressed under high temperature and pressure to cure the glue. The output is a large panel, which is cut into smaller sections (boards or beams). These are then further processed and profiled to become the required shape (for example, for decking: a grooved surface and edge grooved to allow installation with fasteners). As a last step, depending on the customer's request, the boards can be prefinished.

Harvesting after 4-5 years



Modifying the bamboo strands with a heat-treatment at 200°C



Split the Moso bamboo stems, remove the outer skin and crush the strips into strands



Compressing the strands into Thermo-Density® material



Creating the final profile and surface

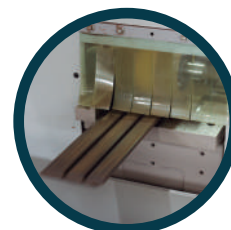

MOSO® Bamboo X-treme®: material is more stable, harder and stronger than almost any other hardwood in the world!

Thermo-Density®

We call the combination of compressing and thermally treating strands a Thermo-Density® process. It increases the density from 650-700 kg/m³ to approx. 1.150 kg/m³ and improves the hardness of this product significantly. After pressing, the material is stronger and harder than almost any other hardwood in the world. At the same time, the dimensional stability of bamboo is improved by approximately 50%.

Besides stability and hardness improvements, the durability is improved to the best durability class possible, from Class 5 to Class 1: Class 1 (EN 350) CEN/TS 15083-2 - simulated graveyard test and Class 1 (EN 350) CEN/TS 15083-1.

durability class according to EN 350 (CEN/TS 15083-2 / CEN/TS 15083-1)

| | 5 | 4 | 3 | 2 | 1 |
|-----------------------|---|---|---|---|---|
| MOSO® Bamboo X-treme® | | | | | |
| Ipé | | | | | |
| Strand Woven Bamboo | | | | | |
| Bangkirai | | | | | |
| Oak | | | | | |
| Scots Pine | | | | | |

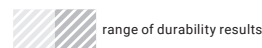

MOSO® Bamboo X-treme® is also well protected against superficial fungi Class 0 (EN 152), and achieves the use/risk Class 4 according to EN 335.

Only MOSO® can ensure you have the original, unique Bamboo X-treme® product. Other products that attempt to copy the original, do not offer the same quality or level of durability, dimensional stability and ecology. With a look-alike product, there is a large risk of claims after installation. **Always ask for the original, certified MOSO® Bamboo X-treme® products!**

Discover the **Bamboo** benefits



Hard & durable

- Biological durability Class 1 (EN 350 / CEN/TS 15083-2), simulated graveyard test / Class 1 (EN 350 / CEN/TS 15083-1).
- Use Class 4 in accordance with EN 335.
- Effectiveness against blue stain Class 0 (EN 152).
- Exceptionally hard: Brinell >9.5 kg/mm² (harder than any tropical hardwood available).
- MOSO provides Bamboo X-treme® outdoor products with up to 25 years warranty.
- Gripsure provides a 15-year non-slip performance warranty.



High stability

- Very stable as a result of a unique Thermo-Density® process of heat-treatment combined with High Density® compression.
- Far more stable than tropical hardwoods - enabling an end-match system (tongue & groove on ends).
- Limited tendency to torsion.
- No gap between the ends of the boards necessary.
- Only 5-6 mm expansion space between the boards.

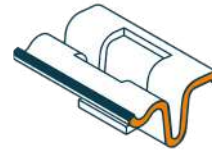

Easy to install

- Can be installed using hidden fasteners (edge grooved) or face screwed.
- Both sides of the board - grooved or flat - can be used.
- Fixed board length 1850 mm, easy for 1 person to install, no complicated installation plans necessary.
- MOSO® Fasteners make it easy to install and uninstall.
- End-match system simplifies the installation by allowing the joint to float between the joists.
- Complementing Thermo-Density® sub frame joists available.



Economical

- Simple and fast installation: up to 30% savings in installation costs!
- Reduced waste because of the end-matched connection.
- Cost effective transportation because of the fixed 1850 mm length.
- Cost effective and space reducing stocking because of unique multi usable board.



Beautiful appearance

- A beautiful, natural hardwood look.
- Choice of flat or grooved surface in one reversible board.
- Use of hidden MOSO® Fasteners avoids face screwing and plugging.
- Free of knots and natural plant resins.
- Choice between natural greying or retaining the brown colour with an exterior finish.



Endless resource

- Made from bamboo; with a growing speed of up to 1 meter per day it is the fastest growing plant on earth.
- Ready to harvest after 4-5 years (compared to up to 100 years for hardwood species) - no deforestation.
- Consisting of approx. 90% natural bamboo.



CO₂ neutral

- Official LCA and carbon footprint studies (EN 15804) confirm that MOSO® Bamboo X-treme® is CO₂ neutral during the product lifespan*.
- No use of fungicide in the production.



Fire rated

- Achieves fire resistance Class Bfl-s1 (decking) and B-s1-d0 (cladding, fencing, beams) (EN 13501-1) without use of fire retardants.
- Achieves flame spread index Class A following ASTM E84.
- As a result, MOSO® Bamboo X-treme can be easily applied in public projects without additional protective measures.

*) This includes the CO₂ (biogenic carbon - EN 16449) stored in the product.

WARRANTY
25
YEARS



Tim Baynham - Wildlife Safety Solutions

Imagine Africa - Luxury Tented Camp (900 m²) South Africa

The Mayfair Townhouse Hotel

London

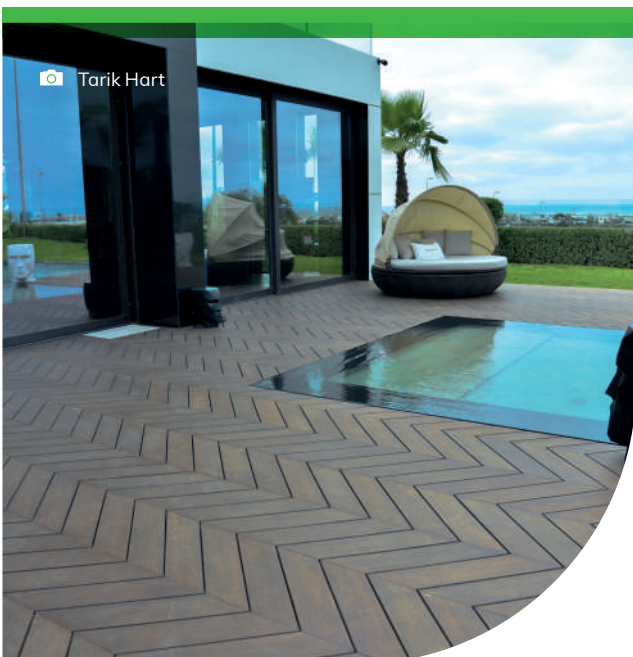

Tarik Hart



Tom Nicholson

6

Private Residence Casablanca

Casablanca, Morocco

MOSO® Bamboo decking range

Bamboo X-treme® Standard Groove / Flat

A special, unique Thermo-Density® process at 200°C provides MOSO® Bamboo X-treme® the highest durability class possible in the appropriate EU norms and increases the hardness and stability. The special symmetrical shape of the sides offers the possibility to choose between either the grooved or the flat surface.

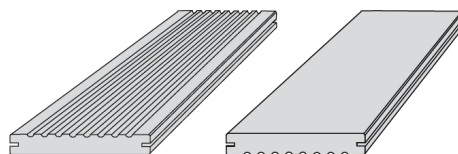

Bamboo X-treme® Decking Groove / Flat 137 mm

| | |
|----------------|---|
| Installation | On joists, with fasteners or screwed |
| Edges | Longitudinal sides with radius, end sides beveled |
| Dimensions | 1850 x 137 x 20 mm |
| Finish | Oiled Woca, end sides sealed |
| Product code | BO-DTHT171G |
| Finish | Finished sikkens Cetol, end sides sealed |
| Product code | BO-DTHT171G-01 |
| Finish | Unfinished |
| Product code | BO-DTHT170G |
| Board | 0.253 m ³ - 1.85 m ¹ - 5.5kg |
| Pallet content | 192 pcs. - 48.66 m ² - 355.2 m ¹ - ca. 1100kg |



Bamboo X-treme® Decking Groove / Flat 155 mm

| | |
|----------------|--|
| Installation | On joists, with fasteners or screwed |
| Edges | Longitudinal sides with radius, end sides beveled |
| Dimensions | 1850 x 155 x 20 mm |
| Finish | Oiled Woca, end sides sealed |
| Product code | BO-DTHT191G |
| Board | 0.287 m ³ - 1.85 m ¹ - 6.3 kg |
| Pallet content | 168 pcs. - 48.178 m ² - 310.8 m ¹ - ca. 1100kg |



Bamboo X-treme® Decking Groove / Flat 178 mm

| | |
|----------------|---|
| Installation | On joists, with fasteners or screwed |
| Edges | Longitudinal sides with radius, end sides beveled |
| Dimensions | 1850 x 178 x 20 mm |
| Finish | Oiled Woca, end sides sealed |
| Product code | BO-DTHT211G |
| Finish | Finished sikkens Cetol, end sides sealed |
| Product code | BO-DTHT211G-01 |
| Finish | Unfinished |
| Product code | BO-DTHT210G |
| Board | 0.329 m ³ - 1.85 m ¹ - 6.9kg |
| Pallet content | 144 pcs. - 47.42 m ² - 266.4 m ¹ - ca. 1100kg |

Bamboo X-treme® Decking 30 mm - Standard Groove / Flat

The board shape offers the possibility to choose between either the grooved or the flat surface. The 30 mm thickness allows installation with more space between the joists or more load on the normal span.

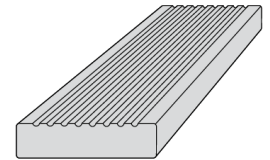

Bamboo X-treme® Decking Groove / Flat 137 x 30 mm

| | |
|----------------|---|
| Installation | On joists, screwed |
| Edges | Longitudinal sides with radius, end sides beveled |
| Dimensions | 1850 x 137 x 30 mm |
| Finish | Oiled Woca, end sides sealed |
| Product code | BO-DTHT371 |
| Board | 0.253 m ³ - 1.85 m ¹ - 8.3kg |
| Pallet content | 128 pcs. - 32.44 m ² - 236.8 m ¹ - ca. 1100kg |

Bamboo X-treme® Decking - Curved

MOSO® Bamboo X-treme® “Curved” means that the surface is slightly convex and smoothly planed. Due to the light, central elevation of 1.5 mm, the water drains directly to the side, so that the boards, e.g. after rain, quickly dry up again and become less dirty. The new shape also makes installation easier – unlike other decking boards, no slope is required for the installation.

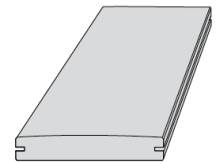

Bamboo X-treme® Decking Curved 155 mm

| | |
|----------------|--|
| Installation | On joists, with fasteners or screwed |
| Edges | Longitudinal sides with radius, end sides beveled |
| Dimensions | 1850 x 155 x 20 mm |
| Finish | Oiled Woca, end sides sealed |
| Product code | BO-DTHT191G-C |
| Finish | Brushed, oiled Woca, end sides sealed |
| Product code | BO-DTHT191G-C-R |
| Board | 0.287 m ³ - 1.85 m ¹ - 6.3kg |
| Pallet content | 168 pcs. - 48.178 m ² - 310.8 m ¹ - ca. 1100kg |

MOSO® Bamboo N-durance®

MOSO® Bamboo N-durance® Decking is a solid, Outdoor-Density® board, made from compressed bamboo strips. Bamboo N-durance® has a warm caramel colour, resulting from a steam-pressure treatment on the bamboo material. A special crushing and compression technique increases the hardness and stability and provides MOSO® Bamboo N-durance® with the highest durability class possible in the appropriate EU norms.

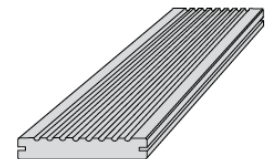

Bamboo N-durance® Decking Groove / Flat 137 mm

| | |
|----------------|---|
| Installation | On joists, with fasteners or screwed |
| Edges | Longitudinal sides with radius, end sides beveled |
| Dimensions | 1850 x 137 x 20 mm |
| Finish | Oiled Woca, end sides sealed |
| Product code | BO-DTC171G |
| Board | 0.253 m ³ - 1.85 m ¹ - 5.92 kg |
| Pallet content | 192 pcs. - 48.66 m ² - 355.2 m ¹ - ca. 1140kg |

MOSO® Bamboo with Gripsure decking range

Gripsure have created a slip resistant version of the MOSO® Bamboo decking, combining sustainability and durability with long-lasting safety. Gripsure have over 30 years' experience in non-slip coatings and hold the highest slip ratings on the market, ensuring a safe solution for any commercial or residential project. We understand that decking is not just for summer which is why our boards guarantee to keep you on your feet all year round, whatever the weather.

Slip resistance

Gripsure non-slip decking has been independently tested using the pendulum test (the operation and calibration of which are described in BS7976:2002 parts 1 and 3) operated to the United Kingdom Slip Resistance Group Guidelines (UKSRG). Gripsure Bamboo will achieve a minimum wet PTV value of 79+.

HSE gives 3 categories of risk for PTV scores to be measured against:

| PTV Value | Slip Potential |
|-----------|-------------------------|
| 0-24 | High risk of slipping |
| 25-35 | Medium risk of slipping |
| 36 + | Low risk of slipping |



Bamboo X-treme® Non-Slip Decking Groove / Flat 137 mm

| | |
|-------------------|---|
| Installation | On joists, with fasteners or screwed |
| Edges | Longitudinal sides with radius, end sides beveled |
| Dimensions | 1850 x 137 x 20 mm |
| Anti-slip inserts | 2 non-slip inserts with grey bauxite aggregate. Different aggregate colours are available on request. |
| PTV rating | 79 + |
| Finish | Oiled Woca, end sides sealed |
| Product code | BO-DTHT |
| Board | 0.253 m ³ - 1.85 m ¹ - 5.5kg |
| Pallet content | 168 pcs. - 48.178 m ² - 310.8 m ¹ - ca. 1100kg |



Bamboo N-durance® Non-Slip Decking Groove / Flat 137 mm

| | |
|-------------------|---|
| Installation | On joists, with fasteners or screwed |
| Edges | Longitudinal sides with radius, end sides beveled |
| Dimensions | 1850 x 137 x 20 mm |
| Anti-slip inserts | 2 non-slip inserts with grey bauxite aggregate. Different aggregate colours are available on request. |
| PTV rating | 79 + |
| Finish | Oiled Woca, end sides sealed |
| Product code | BO-DTHT |
| Board | 0.253 m ³ - 1.85 m ¹ - 5.92 kg |
| Pallet content | 192 pcs. - 48.66 m ² - 355.2 m ¹ - ca. 1140kg |

MOSO® Bamboo

accessories

The MOSO® Bamboo X-treme® Accessories are made of the same material as the decking boards: Thermo-Density® heat-treated bamboo.



Bamboo X-treme® Sub Frame Joist

| | |
|----------------|--|
| Finish | Unfinished |
| Edges | Square edge |
| Dimensions | 2440 x 60 x 40 mm |
| Product code | BO-SB155 |
| Beam | 2.44 m ³ - 6.5 kg |
| Pallet content | 180 pcs. - 439.2 m ¹ - ca. 1200kg |



Bamboo X-treme® Edge Profile 20 mm

| | |
|----------------|--|
| Finish | On joists, with fasteners or screwed |
| Edges | Longitudinal sides with radius, end sides beveled |
| Dimensions | 1850 x 65 x 30 mm |
| Product code | BO-DTHTBN171G |
| Beam | 0.12 m ² - 1.85 m ¹ - 2.8 kg |
| Pallet content | 312 pcs. - 37.52 m ¹ 577.2 m ¹ - ca. 877kg |

The MOSO® Bamboo N-durance® additional products are made of the same material as the decking boards: Outdoor-Density® bamboo. The edge profile is intended for an elegant finish of the sides of the decking. Edge profiles can also be used to create stairs.



Bamboo N-durance® Edge Profile 20 mm

| | |
|----------------|--|
| Finish | On joists, with fasteners or screwed |
| Edges | Longitudinal sides with radius, end sides beveled |
| Dimensions | 1850 x 65 x 30 mm |
| Product code | BO-DTCBN171G |
| Beam | 0.12 m ² - 1.85 m ¹ - 2.8 kg |
| Pallet content | 312 pcs. - 37.52 m ¹ 577.2 m ¹ - ca. 877kg |

MOSO® Bamboo accessories

Fasteners and screws

MOSO® Bamboo Decking can be easily installed with MOSO® Fasteners, alternatively screwed down. When installed with fasteners, there will be 5-6 mm gaps between the boards. The fasteners are supplied with matching stainless steel screws (square bit). For installation on aluminium sub frame joist, special screws are available.



© Moso

Fasteners Asymmetric with Screws

| | |
|---------------------|---|
| Material | Stainless Steel A2 (AISI304) |
| Colour | Brown |
| Fastener dimensions | 27 x 22.5 x 10.8 mm |
| Screwn dimensions | 4.5 x 30 mm |
| For boards | 20 mm |
| Product code | CLIP - SCREWBX08 |
| Sales unit | 90 pcs. In each box 1 screw bit (square) is supplied. |



Fasteners Start/End with Screws

| | |
|---------------------|---|
| Material | Stainless Steel A2 (AISI304) |
| Colour | Brown |
| Fastener dimensions | 27 x 17 x 31 mm |
| Screwn dimensions | 4.5 x 30 mm, metal colour |
| For boards | 20 mm |
| Installation | Screw on top of the joist |
| Product code | CLIP - SCREWBX802 |
| Sales unit | 30 pcs. In each box 1 screw bit (square) is supplied. |

Recommended quantity*

- 137 mm - 20 Pcs./m²
- 155 mm - 17 Pcs./m²
- 178 mm - 14 Pcs./m²

* Based on distance of 462.5mm between the sub frame joist axes.

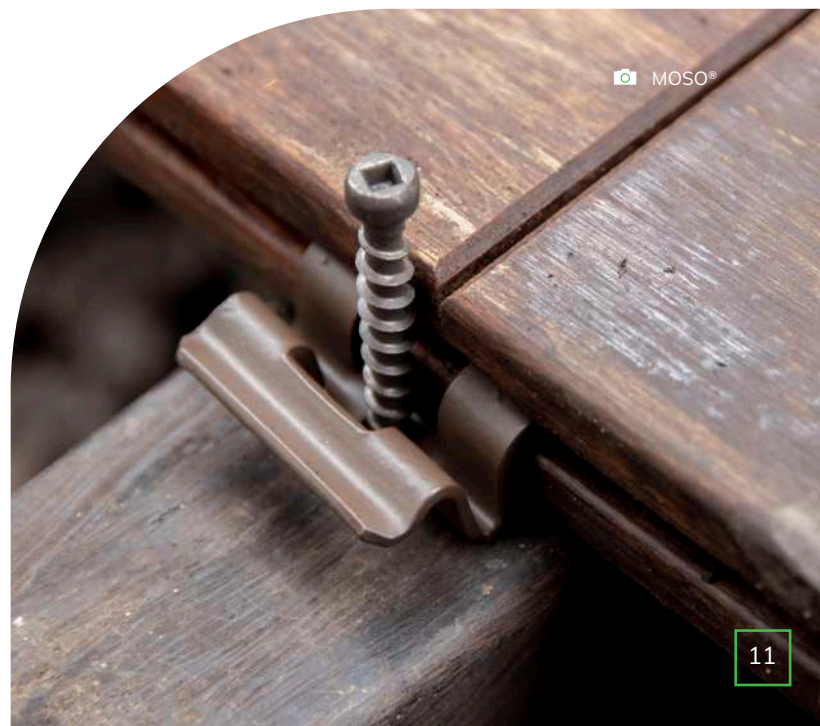

MOSO® Bamboo

installation instructions

Before installation

- Waterlogging under the decking must be avoided by preparing a water permeable ground structure. This can be achieved by sand layers and gravel dispersion above.
- Use cement/stone tiles 40-50 mm thick or pedestals, to support the sub frame (see drawing).
- Place a root barrier under the tiles and pedestals to prevent weeds growing under the decking.
- Install the decking boards with a slope of 1-2% to enable water to run off the surface.
Alternatively, the decking can be installed without a slope, but due to the fact that water stays on the surface longer, it is possible more superficial cracks will develop. If the installation is done without a slope, more cleaning will be required.
- The decking with the curved surface BO-DTHT191G-C can be installed without a slope. Thanks to the curved surface, fast drainage from the boards is guaranteed.
- Ensure good ventilation of the decking by keeping at least 20 mm gap from walls and objects and avoid closing the decking at the sides. The gap between the boards must be open to ensure unrestricted ventilation.
- When the surface / soil underneath the decking is not fast drying, there should be at least 100 mm distance between the decking and the surface underneath.

- Use sub frame joists with the minimum size of 40x60 mm. MOSO® recommends the use of MOSO® Bamboo X-treme® Sub frame joists, which are specifically produced for use in combination with our decking products. Alternatively, suitable joists are those with the same durability class as the decking; aluminum sub frame joists, stable hardwood joists or pine joists. When using hardwood or pine as joists, make sure the moisture content of these joists is below 12%. Avoid direct contact with the soil.
- MOSO® Sub frame joists can be installed without gaps, connecting the joists with screws and glue suited for outdoor use. Other sub frame joists should be installed according to the instructions of the supplier.
- In order to create a stable deck frame, the outsides of the frame have to be connected at regular intervals to the ground / structure below. Alternatively cross bracing can be applied.
- Install the boards on sub frame joists with 462.5 mm space between the joists (centre-to-centre) so each board is supported by 5 joists. Always install the ends of the boards exactly on the joist. Distance between sub frame joist depends on category of use. For non-residential use, please contact MOSO.
- If a random installation pattern is preferred, make sure that the sub frame joists (centre-to-centre) are no more than 300 mm apart.
- Always install cut boards on at least 3 sub frame joists.

Please note

- The MOSO® Bamboo X-treme® Outdoor Decking Board is a natural product, some variation in colour, grain and appearance is normal. Colour can change fast from dark brown to brown or grey, depending on the climatic conditions and maintenance schedule. Occasionally, some bleeding can appear.
- Small cracks and splinters on the surface and on the end of the boards can arise from the different drying characteristics of the surface and cross cut ends. The surface will also get rougher over time. This phenomenon is normal for most wood species and is minimised for this product by its unique 'Thermo-Density®' production method. Cracks on the board ends can be further minimised by applying sealer to the ends of the boards (see 'the installation').
- Splinters and roughness can be removed by cleaning the surface of the decking with the silicon carbide broom or machine disk which MOSO supplies. The surface will become smoother and splinters are removed.
- Dimensional changes or cupping of the boards can occur after installation. This phenomenon is normal for most wood species and is minimized for this product by its unique Thermo-Density® production process.
- When using the flat side of the boards as top surface please note that deformation under influence of climate may be more visible. Some deformation and/or cupping of the material can occur. This phenomenon is normal for outdoor exposed wood and cannot be grounds for a claim.

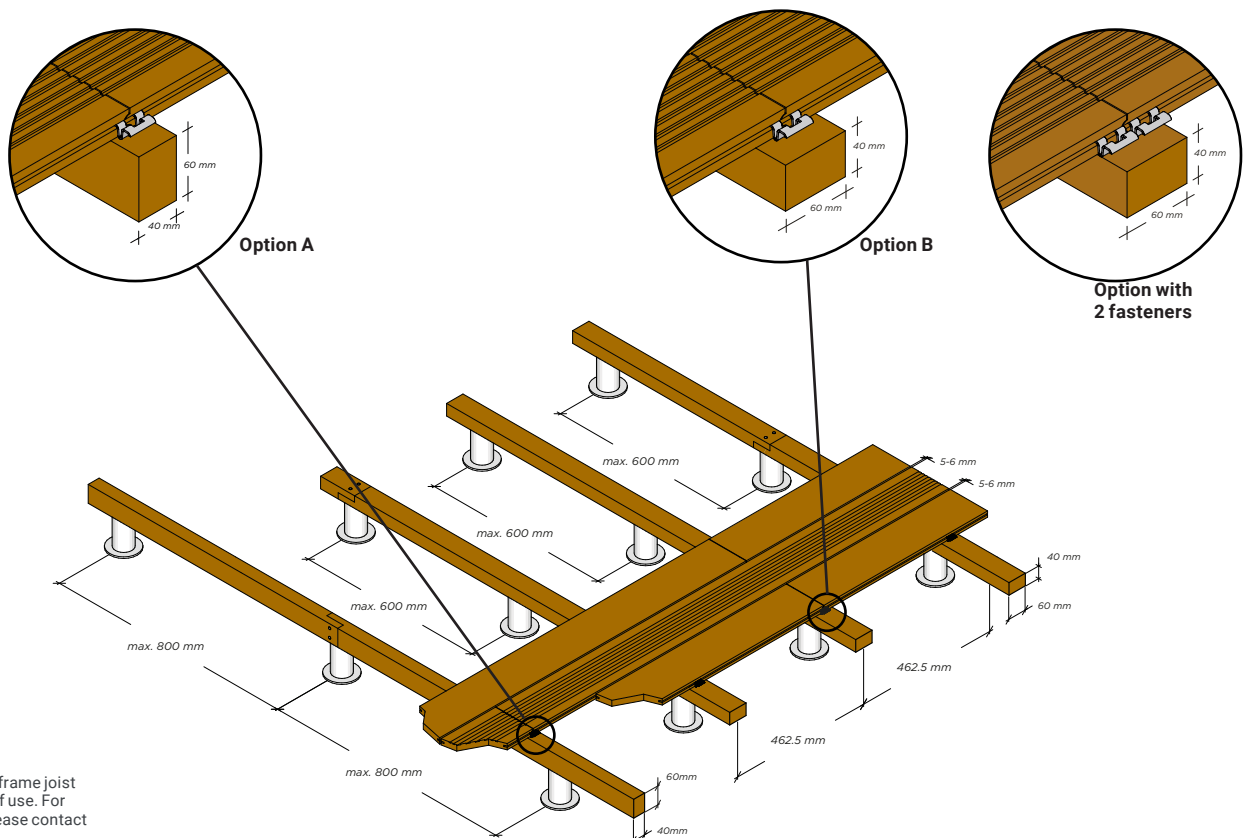

Distance between sub frame joist depends on category of use. For non-residential use, please contact MOSO®.

MOSO® Bamboo

installation instructions

The installation

- Keep at least 5-6 mm gap between the boards (in width direction). With MOSO® Bamboo X-treme® Fastener installation this is automatically the case.
- Because of the stability of the boards and the end-match system, no expansion gap is needed on the ends of the boards.
- Every cut end has to be treated with board end sealer, to prevent water penetration. A sealer is available from MOSO.
- We advise to oil the decking shortly after installation but no later than after the first winter. The best time is 3-4 months after installation when the surface is more open than immediately after installation.

Installation with MOSO® Asymmetric Fasteners

- Determine the surface side of the boards (grooved or flat surface).
- Press fastener with hooked side in the edge groove of one board.
- Pre-drill the joist screw holes 30 mm deep. On bamboo joists: use a 3.5 mm wide drill bit 110 mm long.
- Fully tighten the screw. Always screw vertically to the joist. Apply low torque with slow screwing speed on the screwing machine. Perform some tests for correct torque and speed adjustment before full installation.
- Install every following board by sliding it under the waved side of the fasteners.
- Use approx. 20/17/14/13 fasteners per m², this depends on the board width. When the tongue and groove are connected on the joist, use 1 fastener (preferably 2 fasteners) to tighten both boards (see drawing page 9 option A / B).
- For bamboo or wood joists only use the included stainless steel decking screws (4.5 x 30 mm).
- Please watch the installation video www.moso-bamboo.com/youtube/x-treme

Screw down installation

- Determine the surface side of the boards (grooved or flat surface).
- Pre-drill the screw holes 20 mm from the side of the board. Be sure to pre drill with a large enough drill (80% of screw diameter) to avoid cracking of the decking.
- Always screw both sides (left and right in the width direction) of the board.
- Use at least A2 stainless steel quality decking screws: approx. 5 x 50 mm for 20 mm thickness decking board. Approx. 5 x 70 mm for 30 mm thickness decking board.

Chevron installation

It is also possible to install the decking boards in a chevron pattern. Please follow the installation instructions at:

www.moso-bamboo.com/decking-chevron

Edge profile installation

- When finishing the edge of a deck with the MOSO® Bamboo X-treme® Edge profile, it is important to place the hooked side of the MOSO® Fastener in the edge profile grooves (see drawing below).
- The edge profile can also be used for stairs. Standard Bamboo X-treme® stair dimensions are available in the table below. For other dimensions, boards have to be cut to size and either installed screwed down through the board or with fasteners in new edge grooves made on site.
- In case of stair application: Install decking and edge profiles on the decking steps substructure in the following sequence (the numbers refer to the drawing below):
 1. Attach the edge profile(s) in the inner corner of the steps to the sub structure with MOSO® Asymmetric Fasteners. Place fasteners with a maximum centre-to-centre distance of 462,5 millimeters. Ensure the hooked side of the MOSO® Fastener (see drawing below) is placed in the edge grooves of the edge profile. Fully tighten the screws.
 2. Slide the horizontal decking board(s) in place. Do not fix the other side yet (so no fastener placed).
 3. Slide the vertical decking board(s) in place and attach the top side to the substructure with fasteners. Ensure the waved side of the fastener is placed in the edge groove of the board. Do not fully tighten the screws yet.
 4. Slide the outer corner edge profile(s) in place. Slide MOSO® Asymmetric Fasteners between the decking board(s) (nr. 2 & 3 in the drawing below) and the edge profile(s), ensuring correct orientation of the fasteners. Attach to the sub structure. Fully tighten the screws.
 5. Fully tighten the screws left unsecured in step 3.

Run/rise dimensions

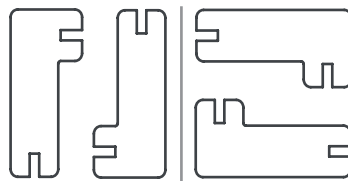

vertical orientation
run (board 2)
137 mm = 189 mm
155 mm = 207 mm
178 mm = 230 mm

horizontal orientation
run (board 2)
137 mm = 259 mm
155 mm = 277 mm
178 mm = 300 mm

rise (board 3)
137 mm = 259 mm
155 mm = 277 mm
178 mm = 300 mm

rise (board 3)
137 mm = 189 mm
155 mm = 207 mm
178 mm = 230 mm

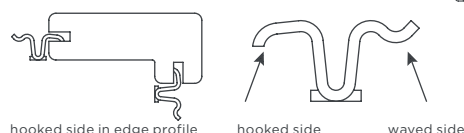
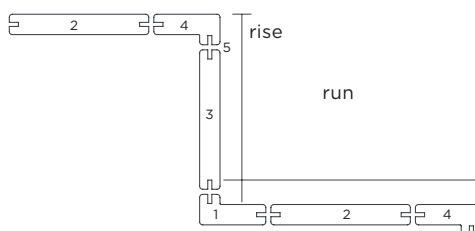

hooked side in edge profile

hooked side

waved side

Cleaning and maintenance

Prefinished version

- MOSO® Bamboo Outdoor Decking is pre-oiled, double sided, with Woca Exterior Wood Oil (teak colour).
- Clean the floor at least one time per year with Woca Exterior Wood Cleaner and the silicon carbide broom or disk. Follow the instructions at: www.moso-bamboo.com/youtube/x-treme Depending on climate and use it may be necessary to perform cleaning more than once per year.
- Remove the dirt water residue on the boards with clean water and let the surface dry.
- Apply 1-2 new layers of Woca Exterior Wood Oil (teak colour). This maintenance should be undertaken 1-2 times a year to prevent the bamboo becoming grey and losing its characteristic bamboo grain. The best time to do initial oiling is 3 to 4 months after installation, or after the first winter, when the surface is more open than immediately after installation. Follow the instructions at: www.moso-bamboo.com/youtube/x-treme
- It is advisable to keep the decking free from dust and dirt as much as possible (clean by broom regularly).

Unfinished version

- You can leave the decking without any maintenance, but take into consideration that without maintenance and oiling the deck will develop a rougher, fissured surface that will lighten quicker and become grey (similar to most timber).
- Maintenance with Woca Exterior Wood Oil is recommended. The best time to do initial oiling is 3 to 4 months after installation, when the surface is more open than immediately after installation.
- Clean the decking with clean water, cleaner and silicon carbide broom or disk.
- Let the decking dry. When the decking is completely dry please follow MOSO® maintenance & cleaning instructions for oiling.
- After this first application the decking can remain without oil treatment for natural greying. However annual cleaning with the silicon carbide broom or disk is obligatory. If you want to keep a darker colour, regular application with Woca Exterior Wood Oil is needed.
- It is advisable to keep the decking free from dust and dirt as much as possible (clean by broom regularly).

Storing

Store in a cool and dry place away from direct sunlight, and protected from weather influences, dirt and dust.

Additional note

Whilst all due care is taken to ensure the accuracy of the installation instructions, individual circumstances (location, sub floor and installation procedures) may vary and are beyond the manufacturer's control. In case of doubt, therefore, consult the distributor. Always follow the local building code.

These instructions are subject to change. For the latest version visit: www.moso-bamboo.com/x-treme/decking

Copyright © Nothing from this text may be reproduced without the prior permission in writing from MOSO International BV.

MOSO® Bamboo

maintenance & cleaning

Maintenance Woca

The surface of decking is weathered under influence of wind, rain, frost and sunshine (UV). As a result, the surface turns grey, dirty and cracks/splinters will appear. WoodCare Denmark has developed different outdoor cleaning and maintenance products. Woca Exterior Wood Cleaner loosens dirt and removes green growth from the surface, without damaging it.

Maintenance of flat surface

Please be aware that on the flat surface, irregularities in the surface (e.g. cracks, splinters) may be more visible than on the grooved surface. With regular maintenance with Woca Exterior Wood Oil, this will be reduced.



Cleaning

- Soak MOSO® Bamboo X-treme® with plenty of water and leave it for 10 min. If possible use a garden hose. Do not use high-pressure cleaners.
- Mix Woca Exterior Wood Cleaner with water in the ratio 1:2 and apply it. If the decking is extremely dirty, exterior cleaner may be used undiluted. Clean the decking with a silicon carbide broom or machine disk (see accessories). Scrub the soaked material lengthwise following the bamboo grain until the material appears clean. If the decking has been installed flat side up, first scrub at an angle of 45 degrees before scrubbing in the length direction. When using a machine disk this is not necessary. Repeat the cleaning if necessary. Clean the surface carefully with water.
- Leave MOSO® Bamboo X-treme® to dry for approx. 24 hours. The material must be completely dry before oil treatment can be done.



Application of oil

- Apply in dry weather only. Avoid direct sunlight and high temperatures.
- Stir the oil thoroughly before use. Apply an even thin coat of oil with an applicator (see accessories) or a brush (decking with non slip grit only with a brush).
- The oil is cream-coloured when it is wet.
- After a few minutes, the material has an oily appearance as the water is evaporating.
- Wipe off any excess oil with clean cotton cloths after no more than 5-10 minutes.
- Take particular care to remove excess oil from joints and grooves.
- Repeat the above process.
- When the material is dry, it may be polished with a polishing pad or polishing machine to ensure an extra hard-wearing surface. It takes 24 to 48 hours for the oil to harden thoroughly, depending on weather conditions and outdoor temperature. The material should not be exposed to water during this period.
- Pay attention to the ends of the joists and cut ends of the boards, which tend to absorb more water, and finish well to minimise water ingress. A sealer is available from MOSO.

Theoretical consumption

- Mix Woca Exterior Wood Cleaner with water in the ratio 1:2 and apply it. If the decking is extremely dirty, exterior cleaner may be used undiluted.
- Woca Exterior Wood Oil: 12 - 15 m² / litre.

Risk of self-ignition

Due to the risk of self-ignition it is important that oil-wetted cloths are soaked in water and are disposed in a tightly closed container after use. For more details, check the instructions of the finish supplier.

Surface of MOSO® Bamboo X-treme® with different maintenance and cleaning scenarios:

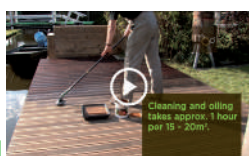
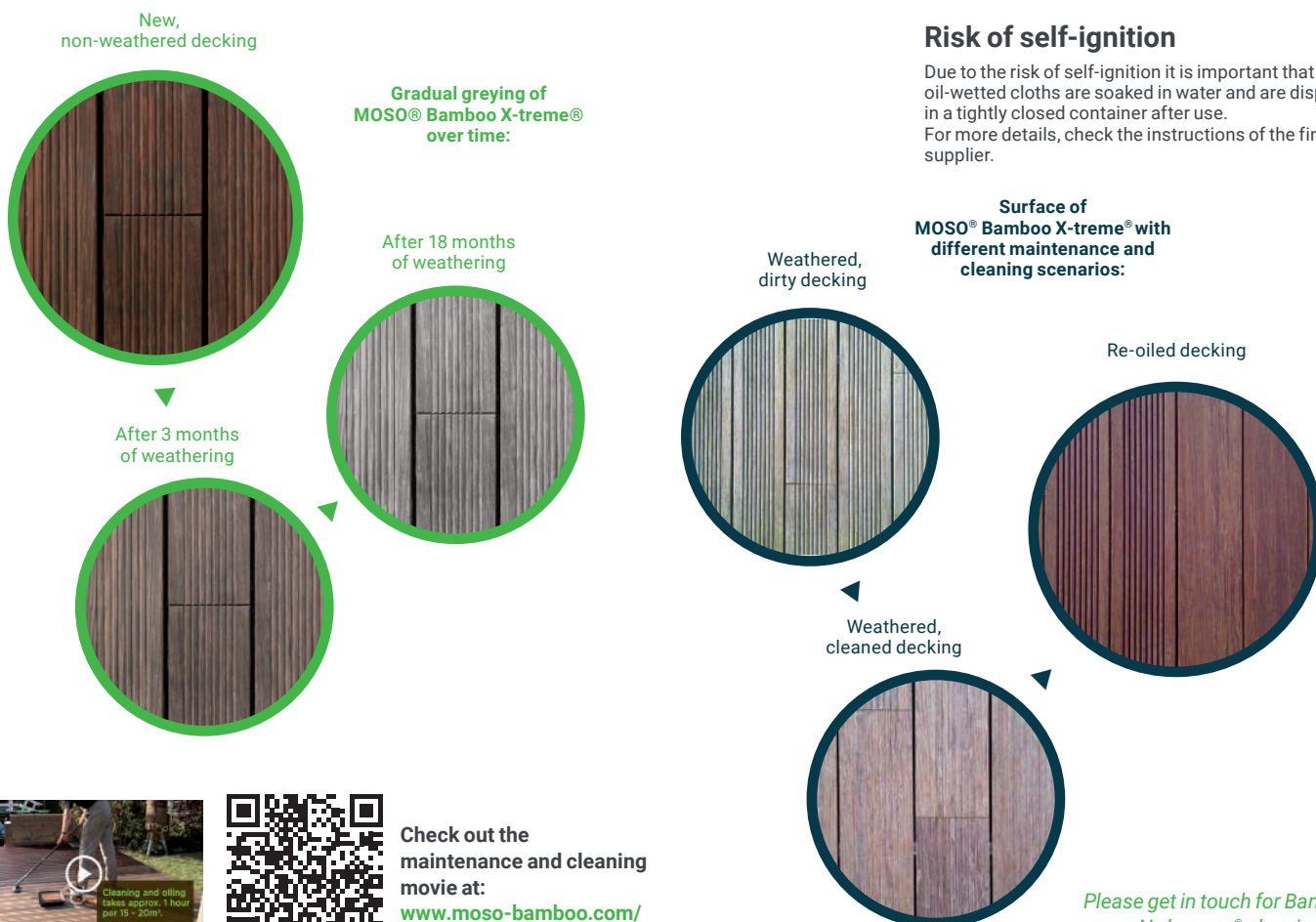

Check out the maintenance and cleaning movie at: www.moso-bamboo.com/ [youtube/x-treme](https://www.youtube.com/watch?v=x-treme)

Please get in touch for Bamboo N-durance® cleaning and maintenance information.



Tom Nicholson

Fenchurch Street London



Tom Nicholson

Malaysian Hut, Eden Project
Cornwall



Tom Nicholson

Private Residence
Cornwall

MOSO® Bamboo

vs. tropical hardwoods

Tour Saint Gobain - La Défense

LEED / BREEAM / HQE - (1000 m²) Paris, France



Valode & Pistre

Daniel Osso

- △ Tropical rainforests across the world have been subject to decades of deforestation due to human pressures such as expanding populations, farming and logging. The area of these forests are decreasing significantly each year
- △ These areas contain the most diverse species and are home to indigenous tribes which are being squeezed out by human activity
- △ Tropical hardwoods are offered with third party accreditation such as FSC to prove it is from well managed forests. However, these forests are only a small proportion of the overall forest where activities are often unregulated
- △ Buying through the EUTR means illegal timber is difficult to sell in Europe but these same standards are not upheld in the rest of the world
- △ Once laid, during the acclimatisation stage, tropical timbers can move and cause post installation issues, especially if the wrong fixings are used. The first rainfall on the deck usually leaches the tannins out of the timber which can stain facades
- △ Typically, tropical species take 40-100 years to grow. Bamboo only takes 5 years to reach maturity and then 20% of the poles from that plant can be harvested each year without killing the mother plant. Trees will only give one harvest every 40-100 years, whereas bamboo will give an annual harvest
- △ Bamboo forests are found in poor soil areas / mountainous regions where nothing else could grow
- △ Bamboo is stronger and as durable as marine grade hardwoods so matches or outperforms these species whilst being much more sustainable

Safe and
stylish

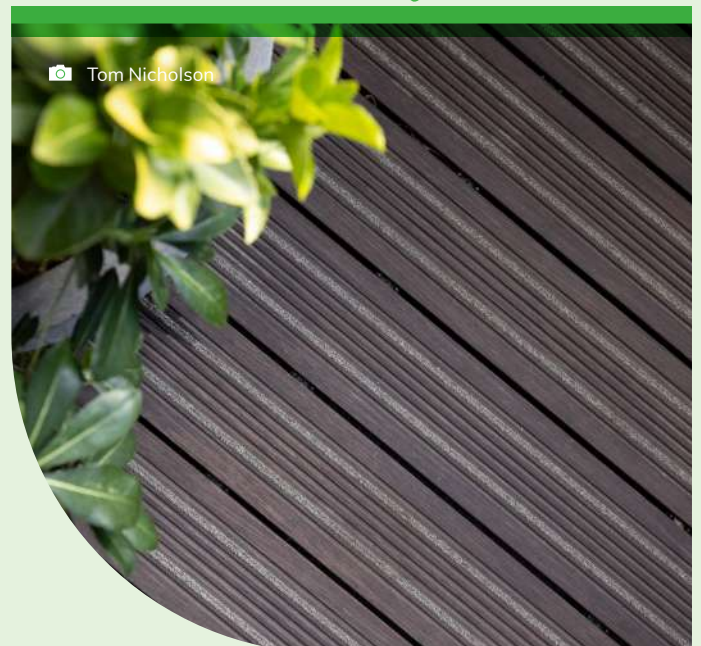

Tom Nicholson

The Mayfair Townhouse Hotel

London



Tom Nicholson

Private Residence
Cornwall



Tom Nicholson

Tropical Biome, Eden Project
Cornwall



Tom Nicholson

Fenchurch Street
London



MOSO® Bamboo

test results

The excellent performance of MOSO® Bamboo X-treme® has been extensively tested by acknowledged research institutes. Find a summary of the most important test results below. Full reports are available upon request. **Only MOSO® can ensure you have the original, unique Bamboo X-treme® product.** Other products that copy the original do not offer the same hardness and level of durability, dimensional stability and ecology. With a look-alike product, there is a large risk of claims after installation. Always ask for the original, certified MOSO® Bamboo X-treme® products!

 Durability of MOSO Bamboo X-treme, *Heat Treated Strand Woven Bamboo*: resistance against soft-rotting micro fungi according to CEN/TS 15083-2

Report code: 17.0083-C Date: 29 March 2017 Page: 8/14

According to EN 350, the durability class is determined based on the x-value. To calculate the x-value, the median mass loss or the test species is compared to the median mass loss of the Beech or Pine references. Hardwoods are compared to Beech, Softwoods are compared to Pine. As Bamboo is neither softwood nor hardwood a comparison is made with both reference wood species Pine sapwood and Beech.

Based on the mass loss found and the comparison to Beech and Pine, the tested MOSO Bamboo X-treme, *Heat Treated Strand Woven Bamboo*, can be classified in durability class 1 when using the method described in EN 350.

MOSO Bamboo X-treme, *Heat Treated Strand Woven Bamboo*, performs comparable to Azobé and Merbau. Little variance is found between the different boards.

Durability

CEN/TS 15083-2
(ENV 807) /
EN 350

class 1

 Durability of het treated strand woven bamboo: resistance against degradation by Basidiomycetes according to EN 350 and CEN/TS 15083-1

Report code: 17.0083-B Date: 29 March 2017 Page: 8/14

According to EN 350, the durability class is calculated based on the mass loss obtained with the fungus resulting in the highest median mass loss. For all fungi the mass loss is less than 5%. This implies that, when using the EN 350 to determine the durability, MOSO Bamboo X-treme, *Heat Treated Strand Woven Bamboo* can be classified in durability class 1.

Durability

CEN/TS 15083-1
(EN 113) /
EN 350

class 1

 Resistance of *Heat Treated Strand Woven Bamboo* against blue staining fungi

Report code: 9.061-E 8 September, 2009 Page: 10/10

4 Conclusion

On behalf of Moso International BV an EN 152 blue stain test was performed on Heat Treated Strand Woven bamboo. UV- weathering was used as preconditioning of part of the samples. The combination of UV light and water spray resulted in strong discoloration of the surfaces of both the bamboo samples and the Pine sapwood reference samples.

Neither on the weathered nor on the original Bamboo samples discoloration of the blue stain fungi or the hyphae of the blue stain fungi could be observed. As a result it can be concluded that the susceptibility of this Heat Treated Strand Woven Bamboo towards blue stain is very low.

Resistance against blue staining fungi

EN 152

class 0

Harder and more durable than almost any other hardwood

Durability class

class 1

(EN 350 (CEN/TS 15083-2 / CEN/TS 15083-1))

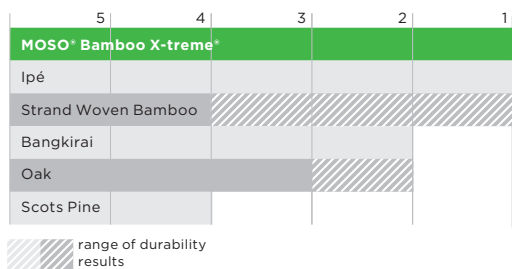

Average brinell hardness

9.5 kg/mm²

(EN 1534)

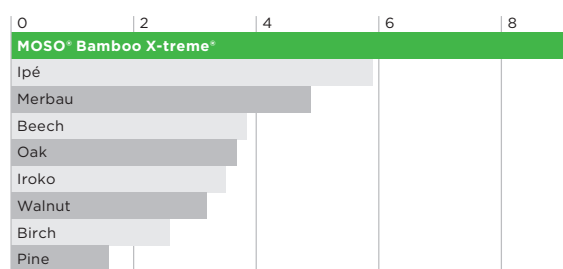

Classification Durability Class

| Use Class | 1. very durable | 2. durable | 3. moderately durable | 4. slightly durable | 5. not durable |
|--------------------------------|-----------------|------------|-----------------------|---------------------|----------------|
| 1 interior | o | o | o | o | o |
| 2 moist interior | o | o | o | (o) | (o) |
| 3 exterior, above ground | o | o | (o) | (o)-(x) | (o)-(x) |
| 4 ground contact / fresh water | o | (o) | (x) | x | x |
| 5 salt water | □ | (x) | (x) | x | x |

- o Natural durability sufficient.
- (o) Natural durability normally sufficient, but for certain end uses treatment may be advisable.
- (o)-(x) Natural durability may be sufficient, but depending on end use, preservative treatment may be necessary.
- (x) Preservative treatment is normally advisable.
- x Preservative treatment necessary.
- Natural durability of Bamboo X-treme® not tested in salt water.

Durability

EN 350 (CEN/TS 15083-2 / CEN/TS 15083-1)

class 1

use/risk class

EN 335

class 4

4. Classification and field of application

4.1 Reference of classification:
This classification has been carried out in accordance with clause 12 of EN 13501-1:2007+A1:2009.

4.2 Classification
The product: **BAMBOO X-TREME™ DECKING**, in relation to its reaction to fire behaviour is classified:
B₁
The additional classification in relation to smoke production is:
s1
Reaction to fire classification: B₁ - s1

3. CLASSIFICATION
The product: **MOSO® Bamboo X-treme**, in relation to its reaction to fire behaviour is classified:
B₁
The additional classification in relation to smoke production is:
s1
The additional classification in relation to flaming droplets / particles is:
d0
Reaction to fire classification: B - s1, d0

Fire resistance

EN 13501-1

decking

class Bfl-s1

cladding, fencing, beams

class B-s1-d0

Classification ASTM E84

| Classification | Flame Spread Index | Smoke Developed Index |
|----------------|--------------------|-----------------------|
| A | 0 - 25 | 0 - 450 |
| B | 26 - 75 | 0 - 450 |
| C | 76 - 200 | 0 - 450 |

Reaction to fire

(FSI 25 / SDI 45)

ASTM E84

class A

WUI approved

CAN/ULC-S102

Carbon Footprint (CO₂eq) per kg final product

Eco-costs (€) per kg final product

| PRODUCTION | END OF LIFE | CO ₂ | CO ₂ | CO ₂ | PRODUCTION | END OF LIFE | ECO-COSTS | ECO-COSTS |
|---------------------------|------------------------|-----------------------|-----------------------|-----------------|------------|-------------|-------------------------|-----------|
| CO ₂ footprint | CO ₂ credit | Storage | Total | Neutral | Eco-costs | Eco-costs | CO ₂ storage | Total |
| CO ₂ eq/kg | CO ₂ eq/kg | CO ₂ eq/kg | CO ₂ eq/kg | Y / N | Euro/kg | Euro/kg | Euro/kg | Euro/kg |
| 1.193 | -0.704 | -0.607 | -0.118 | Yes | 0.356 | -0.132 | -0.082 | 0.142 |



The life cycle and the carbon footprint of MOSO products are evaluated according to ISO 14040/44. For more information: www.moso.eu/lca
The full report is available on request.

Confidential - This information is the property of MOSO International BV, Zwaag, the Netherlands. Any use or reproduction without permission will be prosecuted.



Author:
Dr. Vogtlander J.G. (2014). Life Cycle Assessment and Carbon Sequestration - Update 2014 - Bamboo products of Moso International. Associate professor - Design for Sustainability - Delft University of Technology.

Carbon footprint

ISO 14040/44

CO₂ neutral

The sustainability of MOSO® Bamboo

MOSO® Bamboo X-treme® offers clear sustainable advantages and is even proven to be CO₂ neutral during the product lifespan! The inclusion of Bamboo X-treme® contributes to a higher LEED, BREEAM, Green Star, HQE and DGNB certification score for green building projects. That's one of the reasons why you can find MOSO® Bamboo X-treme® and other MOSO® products in many sustainable reference projects all over the world.

Carbon footprint

MOSO® Bamboo X-treme®: CO₂ neutral during the product lifespan*

MOSO® has conducted an LCA and carbon footprint study together with Delft University of Technology (TU Delft) and INBAR. The report (www.moso-bamboo.com/lca) concludes that all assessed MOSO® Products (all solid bamboo flooring, decking, beams, panels and veneer) are CO₂ negative during the product lifespan ("cradle till grave"). In this result the high growth rate of Moso bamboo has not even been taken into account, and can be perceived as additional environmental benefit. The environmental impact of MOSO® Products, excluding carbon sequestration effect, was also published in an official Environmental Product Declaration (EPD) following EN 15804 (www.moso-bamboo.com/epd).

*) This includes the CO₂ (biogenic carbon - EN 16449) stored in the product.

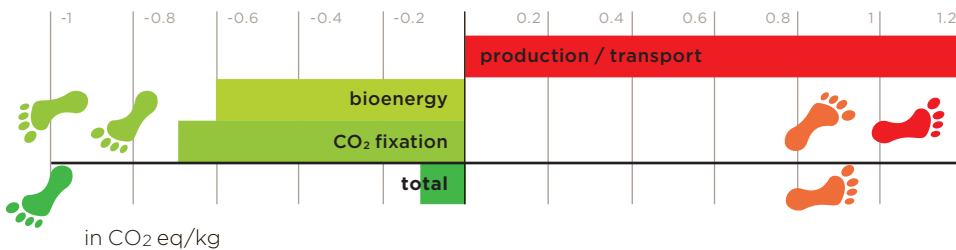

Unsurpassed growing speed

Bamboo: the fastest growing plant in the world

Because of the fast growth, Moso bamboo is managed as an agricultural crop: the annual harvest of the 4 to 5-year-old stems – compared to 60-80 years for tropical hardwood! - provides a steady annual income to farmers and stimulates the bamboo plant to reproduce even faster. Therefore, by default, no deforestation occurs with production of MOSO® Bamboo X-treme®, while large amounts of CO₂ are captured in the bamboo forests and products (www.inbar.int/understanding-bamboos-climate-change-potential).

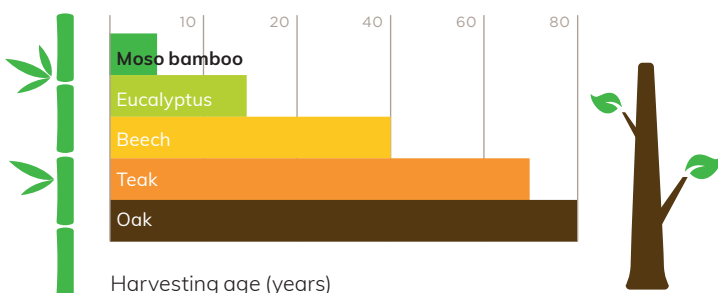

Venco Campus BREEAM

Eersel, the Netherlands



VLCS Architecten
Studio de Brink



Carbon storage in bamboo

Biobased materials act as CO₂ sinks

Through photosynthesis, plants absorb carbon dioxide (CO₂) and convert it into glucose (building block for biomass) and oxygen. The CO₂ is stored in the material for the lifetime of the product, and even longer if the product is recycled into new, durable products. Due to the fast growth – and related high yields - Moso bamboo locks far more CO₂ in durable products compared to wood species. The locked amount of CO₂ can be calculated rather simply by looking at the density of the material and taking into account the biobased content. For example, Bamboo X-treme® locks almost 1.660 kg CO₂ per m³ of bamboo, which is the equivalent of the CO₂ emissions of 14.000 km driven by a mid-range car.

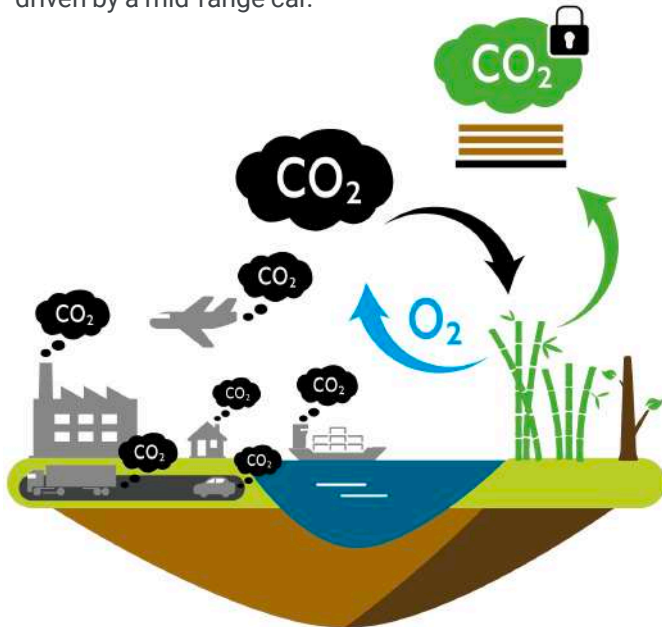

Check out how bamboo can save the world at:
www.moso-bamboo.com/sustainability

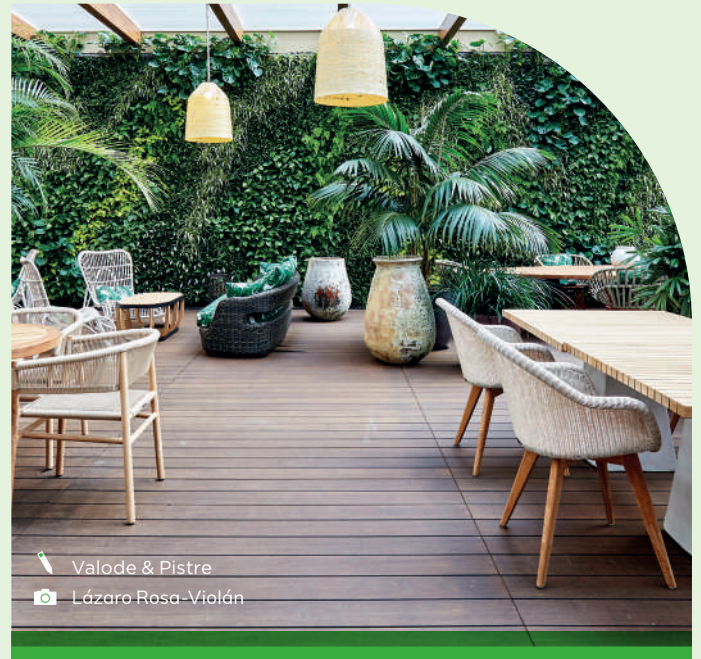

Valode & Pistre
 Lázaro Rosa-Violán

*Contributes to
 the leading green
 building certification
 programs worldwide*



STOFANEL
 Detlef Klose



Fünf Morgen Dahlem Urban Village
 (1750 m²) Berlin, Germany

MOSO® Bamboo

user information

Appearance and colour

MOSO® Bamboo X-treme® is a natural product, which can vary in colour, grain and appearance. Colour will change over time depending on the maintenance schedule. The boards have a brown to dark brown colour when installed, which turns into a lighter caramel colour several weeks after installation. Without further maintenance the colour gets greyish relatively fast (similar to most other wood species).

If a brown colour is preferred, maintenance should be done with Woca Exterior Wood Oil or a comparable waterbased oil/saturator with teak colour pigments.

Directly after installation, but even better after 3-4 months, 1 coat of oil (pre-oiled version) or 2 layers of oil (unfinished version) have to be applied. For further details see the installation instructions. MOSO® Bamboo X-treme® shows similarity to other hardwoods in grain and structure. The characteristic bamboo nodes however can still be recognised and provide the product with a special and lively look.

Swimming pool

If MOSO® Bamboo X-treme® outdoor decking is to be used around swimming pool areas, the following has to be taken into account: MOSO® Bamboo X-treme® is a natural (wood like) product. As with any wooden product used outdoors, there is always a risk of formation of splinters, however splinters from MOSO® Bamboo X-treme® are normally smaller than (tropical) hard wood splinters. A regular application of oil (more frequently necessary around swimming pools) is required to reduce the formation of splinters. Furthermore, regular maintenance with the silicon carbide broom or disk is required to effectively remove splinters and smooth the surface. The boards must be installed in such a way that the surface water cannot flow directly into the pool.

Also bear in mind that treated swimming pool water contains salt and chlorine which can cause the boards around the pool to "weather" and become bleached faster than the boards in areas not exposed to the swimming pool water.

Normal phenomena

Cracks on the surface and on the ends of the boards can occur due to the different drying characteristics of the surface and board ends. This does not affect the stability or durability of the board.

The surface side of the boards will become rougher over time and can form (small) splinters as a result of continuous water absorption and desorption due to dry and wet weather periods. Dimensional change or cupping of the boards can occur after installation. These phenomena are normal for most hardwood species and MOSO® Bamboo X-treme®.

After installation, there might be some bleeding or leaching of colour from the bamboo material when it gets wet, e.g. when it rains. This possible bleeding is typical for wood and will disappear over time. The brownish liquid can easily be cleaned from the Bamboo X-treme® material, however controlled water drainage and prevention of splash water is required to prevent any discoloration of surrounding or underlying building components.



Wet condition



Dry condition

Private Residence Solana Beach low clearance decking installed near a cliff edge by the sea- (325 m²) California, USA



Fraser Decks & Patio Covers
Reily Imagery

*Endless possibilities
and custom made
design products*



Andy Andresen - Qin International GmbH
Studio GA Gollwitzer Architekten GmbH
Qin International GmbH

Altmühltherme Wellness decking with FSC® certification installed on a steel structure - (1000m²) Treuchtlingen, Germany



Tom Nicholson

Fenchurch Street
London

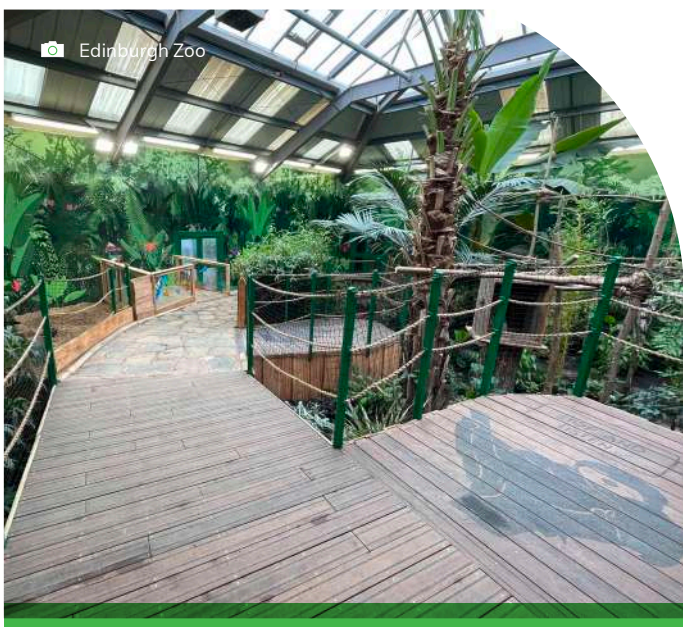

Edinburgh Zoo

Edinburgh Zoo, Sloth Enclosure with custom GripSure Graphics
Scotland

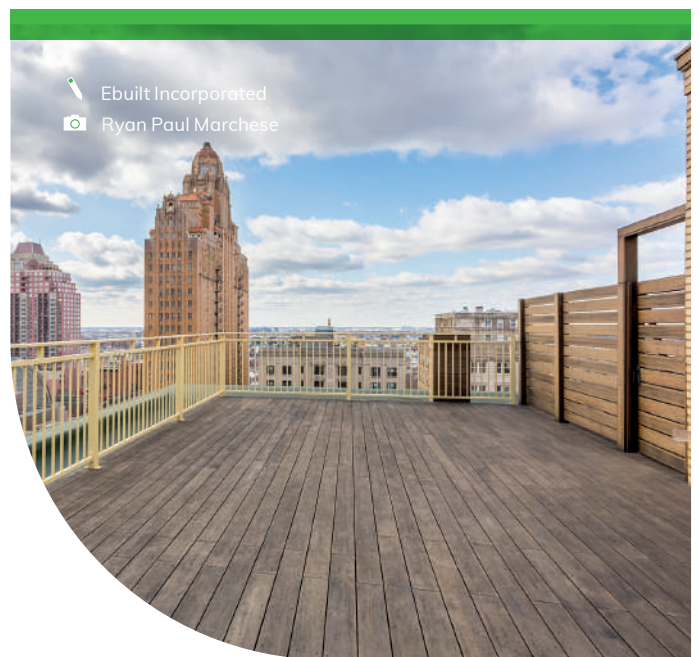

Ebuilt Incorporated
Ryan Paul Marchese

The Versailles Apartment Complex
(418m²) Philadelphia, United States of America



GRIPSURE[®]
keeps you on your feet

For further product information, or to discuss any project requirements, please get in touch with us:

www.gripsure.co.uk
+44 (0)1726 844616
info@gripsure.co.uk

Unit D2(23) Rockhill Business Park, Bugle, Cornwall, PL26 8RA

