



Proludic® 

Designer of play and sports areas





Proludic, an entire team at your service



The staff at Proludic have extensive experience in the play, outdoor gym and sports area industry. As a Proludic client, you will be able to access a dedicated project team, which includes your own assigned Area Manager, Customer Service Advisor and skilled Designer or Landscape Architect.

This combined knowledge and expertise ensure you receive the highest level of customer care, from the initial planning stage right through to project completion.

Proludic supports you from start to finish – and beyond! From the first steps of raising funds and developing your vision, we define the project specifications and manage the planning process with consideration of all details.

These include site evaluations, equipment suitability and landscape integration. All aspects of the project design and delivery are looked at to provide you with the best outcome for your area. The final proposal will have supporting 2D plans and 3D visuals so you can truly see your vision come to life.

We also offer a comprehensive After Sales & Maintenance team who are on hand with service cover for the lifetime of your play and sports area.



**Contact your local Area Manager
directly from our website:
www.proludic.co.uk/contact-us/**



We are active members of the API (Association of Play Industries) and are accredited by both Constructionline and CHAS (The Contractors Health and Safety Assessment Scheme). All our products are independently tested and certified to European Play Standard EN1176 and EN16630 for outdoor fitness equipment. Proludic is also CPD (Continuing Professional Development) accredited.





*Advice and design
planning*



*Project design
and graphic
illustration*



*Project management
and installation*



*Acceptance of work
completed*



*Aftersales
support*



*Maintenance
and servicing*

Let's meet your challenges together!

Proludic is renowned for its ability to create beautiful unique projects. Innovation is in our DNA and we incorporate this into your tailor-made designs. The creativity of our designers combined with our manufacturing quality ensures that you receive an original and durable solution.



C O N T E N T S

2 The company

- 2 Our mission, our values
- 4 Integrated expert knowledge
- 6 Our environmental policy
- 8 Playgrounds: a shining example of inclusion
- 10 Grafic Games
- 12 Bespoke projects
- 16 Our website

18 Multiplay equipment

- 20 Diabolo & Diabolo Baby
- 40 Kanopé
- 64 Vivarea
- 68 Bilibox
- 72 Ixo

82 Themed equipment

- 84 Adventure
- 98 Metropolis
- 106 City
- 120 Aquatica
- 128 Medieval

134 Origin' Robinia wood equipment

- 136 Multiplay equipment
- 144 Themed equipment
- 150 Traditional equipment
- 156 Trails

166 Moving equipment

- 168 Springers
- 182 Rotating equipment
- 190 Cableways

196 Traditional equipment

- 198 Playhouses
- 204 Swings
- 218 Slides

224 Climbing & balancing equipment

- 226 Trails
- 234 Trampolines
- 236 Rope structures
- 244 Climbing equipment

252 Educational & sensory equipment

- 254 GymLudic® trail & Balancing modules
- 258 Play panels, Audio & Musical play
- 266 Sand play, water play and gardening
- 272 Interactive play

276 Sport for all





280 Furniture and Signage

288 Technical services

- 289 Materials
- 294 Index
- 296 Guarantees



LEGEND

-  Age groups
-  Free fall height
-  Number of users
-  Video available by scanning the QR Code
-  New in 2023

INCLUSION LEVEL

The stated inclusion level determines how accessible our equipment is to a child with motor impairments.



At least 1 activity accessible



Presence of a ramp or transfer point or equipment totally accessible

ANCHORING THE EQUIPMENT



Type A
*JXXXA: Anchored under ground in a concrete footing.

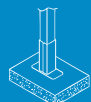

Type B
*JXXXB: Fixing on a concrete slab that has already been laid or will be laid before the equipment is installed.



FOR 35 YEARS, Proludic has been designing, manufacturing and installing playgrounds and sports areas around the world

Our mission

True to our values, we are focused on our mission of creating playgrounds and sports areas where users can thrive, develop their skills and improve their well-being.

We design, manufacture and install products and play spaces offering the highest quality and safety. Our universal, innovative and

inclusive solutions are tailored to meet the wide range of needs among children, teenagers and adults.

We also strive to transform play areas into social hubs that promote and enhance community life.

Recognised quality

ISO 9001
ISO 14001
BUREAU VERITAS
Certification



Endorsed compliance with standards



A certified environmental approach



Award-winning designs



Janus de l'industrie



Janus du service



Janus de la cité

Label observateur du design 10



Our values

Experience

Proludic draws on the operational expertise it has developed since 1988 to provide customers with superior support and guidance in developing and implementing their projects.

Innovation

Proludic harnesses its collective driving force to extend and upgrade its product range to reflect the changing needs of today's generations and tomorrow's world.

Commitment

All our employees share the company's determination to see children thrive, while fostering wellbeing for everyone and enhancing customer satisfaction.

Proximity

All around the world, local teams are ready to respond and bring a dedicated and professional approach to each playground and sports area project.

Learn more in our corporate video.



Our head office and manufacturing facility are based in Vouvray, France.



International presence

6 subsidiaries

55 countries

310 employees

+100 000 playgrounds and sports areas





Integrated expert knowledge



Our in-depth knowledge of children is the driving force behind every project

Every day, our teams are focused on leading projects that strengthen their expertise in children's developmental needs by:

- Working alongside childhood specialists.
- Gathering insights into the latest lifestyles and trends.
- Observing and analysing how children behave on their own, and as part of a group, within their educational play environment.
- Planning to ensure that play experiences promote the development of children's motor, sensory, cognitive, creative and social skills.



Design: inextricably interwoven into Proludic's DNA

Proludic's in-house Research & Development Department is a powerhouse for pioneering innovative ideas that comply with applicable standards.

Our designers are responsible for masterminding leading-edge concepts and product ranges geared towards the expectations of children and adults alike. We also have a long track record in developing bespoke and personalised projects.

- 6 designers and 15 technical engineers.



Integrated manufacturing processes

To better deliver superior efficiency, flexibility and quality, Proludic's manufacturing and distribution functions are based out of the company's head office.

- 60 qualified workers.
- Ability to work with a wide variety of materials, including wood, metal, rope, composites and plastics.
- Quality control and testing on materials and equipment.

Production processes are controlled and managed entirely within the company, meaning that Proludic can manufacture custom products and unique designs with greater responsiveness.



Landscape design

Your project is unique to us!

Each project starts with an initial meeting. This allows us to get to know you as a client and understand your needs, so we can provide a tailor-made design solution in keeping with your brief.

Our combined knowledge and expertise ensure your needs will be carefully assessed, and that we will provide you with advice to ensure consistency across your play area project in terms of products, location, layout and environment. Following this initial consultation, we are then able to create the most appropriate project design to achieve a harmonious and attractive end result.

- 200 salespeople are in the field every day, across the world.
- Landscape designers are at your service.



Installation & project management

ProLudic project manages each play space project from the time you place your order, through to project completion - and beyond.

Our services include:

- Installation of play and sports equipment
- Landscape integration
- General layout works
- Laying safety surfaces
- Aftersales service
- Servicing and maintenance

We carry out all our work in line with the project objectives and follow safety requirements.

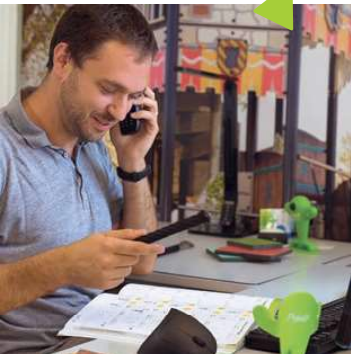

Aftersales service

We are here to help, long after your project is installed. If there is anything you need, we will get back to you as quickly as possible.

Our promise to you?

90% of requests are processed within 24 hours

80% of spare parts are shipped within 5 working days

GET IN TOUCH!

By phone or via our website



A proactive environmental policy



Operating as a professional organisation in the childhood development sector, Proludic's decision to spearhead initiatives aimed at protecting the environment and laying the foundations for future generations has always been an obvious choice.

Today, we are determined to step up our efforts in this area by reinforcing the company's environmental policy with **3** key **cornerstones** :

- ▶ Sustainability
- ▶ Fighting climate change
- ▶ Maintain a strong local presence

We are building new **indicators** to lead and enhance our proactive policy and accurately measure trends in its performance.



Proludic's environmental strategy



Commitment 1 Sustainability

We offer playgrounds, sports areas, equipment and solutions that are capable of standing the test of time and withstanding all weather conditions, however extreme! From the outset, our products have been engineered with sustainable materials that are guaranteed for their longevity (refer to Our Guarantees on page 296). Our products are also designed with reparability in mind to extend their life.

Indicators

9.12

15 years
16 years
17 years...

Reparability index

Proludic is staying one step ahead of the innovation curve by creating the first reparability index for playgrounds and sports areas. Therefore, each item of equipment manufactured by Proludic features an index to determine its reparability score. The average score is 9.12 out of 10.

Average playground service life

According to a global study conducted in 2022, 90% of the playgrounds that Proludic produced over 15 years ago are still 100% functional.



“ True to our values, we are taking tangible action to maximise the service life of our designs and reduce their environmental impact. We are striving to reduce global warming for future generations. ”

Commitment 2 Fighting climate change

We have analysed our activities to reduce our carbon emissions and we have prioritised action on the processes that generate the highest emissions. As such, we are focused on managing and taking action on the design, manufacturing and transportation activities for our playground and sports area equipment, as well as all our travel, to minimise their carbon footprint.

Indicators



Recycled and recyclable raw materials

From the start, Proludic's equipment is designed to incorporate a maximum amount of recycled and recyclable raw materials. 75% of Proludic's products contain recycled raw materials and 88% are recyclable.



Waste recycling

All our processes are designed with an emphasis on recycling waste. 93% of production waste is recycled.

Indicators



Preliminary assessment

To guarantee best-fit and long-lasting playgrounds, the details of each project are given every consideration, including the local inhabitants' needs, the site topography and the playground's seamless integration into the surrounding landscape. 93% of our playground and sports area projects are preceded by a preliminary on-site assessment.



Local suppliers

We make a point of sourcing our raw materials and services from local suppliers. 94% of our suppliers are European, and 72% are based in France where our factory is located.

Check out our environmental policy and indicators on our website:





Playgrounds: a shining example of inclusion

What is an inclusive play area?

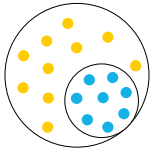



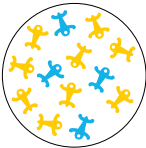

Integrated play area



Inclusive play area designed by Proludic

An inclusive play area is a space featuring an accessible layout and a range of play equipment so that children can express themselves, play together and progress at their own pace and to the best of their abilities.

Our inclusive play areas offer products that have been designed to accommodate various disabilities, such as:

-  motor
-  visual
-  hearing
-  intellectual impairments, autism...

without ever creating any stigma in how they are used or perceived.

What are the key considerations when designing an inclusive play area?

- Use colours, shapes, textures and sounds to stimulate the senses and promote development.
- Provide equipment and spaces that allow children to withdraw for quiet periods.
- Prioritise low-level activities either inside or outside of the play equipment to encourage interaction.
- Improve access to equipment by the presence of a ramp, low floors and safe steps. Offer several easy-access entrances.
- Provide simple activities with gradual progression in levels of difficulty to stimulate children and enable success.
- Create access paths and use appropriate ground markings to facilitate easy movement around the play area.



Inclusive flagship products

Identify all our inclusive products in this catalogue with this pictogram:



Assessment level is in alignment with the Americans with Disabilities Act (ADA)



Inclusive Seesaw p 179



Inclusive All-Terrain Vehicle p 178



Diabolo with ramp

Are you planning to create an inclusive play area?

Ask for a copy of our «Inclusive play areas» catalogue, which illustrates our strong commitment to children with disabilities.

We have designed our catalogue while closely working alongside the Proludic Observatory experts and NovaChild, a network of universal design experts, healthcare professionals and associations for disabled children's associations committed to improving wellbeing for children through the power of innovation.

The catalogue features appropriate solutions in terms of products and designs to ensure that playgrounds can be enjoyed by everyone.

"Inclusive play areas" catalogue



Recipient of the Good Design Award Gold



GOOD DESIGN AWARD GOLD WINNER



Check out our dedicated page at proludic.com:





Grafic Games: unique graphic designs for truly original playgrounds



Original, innovative and audacious all at the same time, the Grafic Games decorative technique has been developed to personalise all our play structures. This technique allows a project to stand out from the crowd and brings real added value to your playground.

- Pro ludic's internal teams are experts in using this technique.
- The finish can be applied to all compact composite and lacquered plywood panels.
- The varnish finish improves the graphics' resistance to graffiti removers.
- The warranties are the same as for all HPL (High Pressure Laminate) compact composite and lacquered plywood panels (25 years).

6 GRAPHICS
are available in
our catalogue



GRAFIC



MIEVEAL



OCÉANE



AMAZONE



ETNIK



METROPOLIS



**GRAPHIC GAMES:
a decorative technique
to satisfy all your needs**

- Corporate identity
- Customised designs reflecting the local heritage
- Greater play value
- Theme-based graphic designs
- Collaborative projects

Find out more



*Any other ideas?
Our imagination has no limits!*



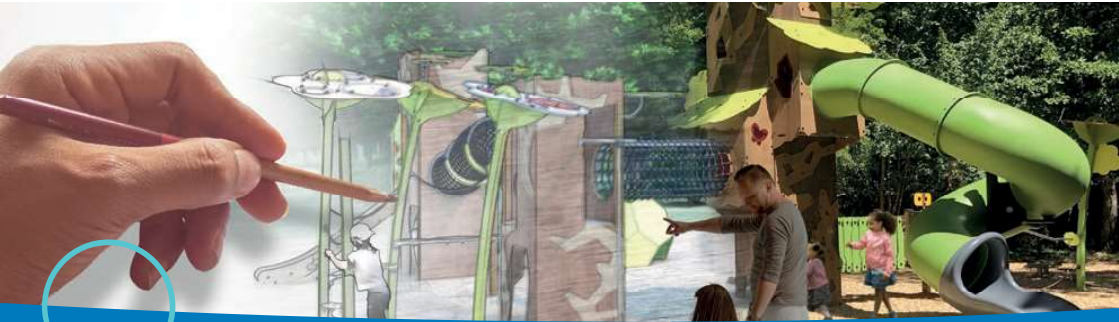

Bespoke projects, you dream it... we create it

At Proludic, the only thing that we like more than being part of your project dreams, is turning them into a reality!

Drawing strength from our expertise in design, engineering, manufacturing and installation, we combine creative flair and high standards to create unique and spectacular designs.

We relish the challenge of breaking with convention, starting with a blank canvas and breathing life into all our customers' ideas.

Our creations come to life in the most varied play environments with larger, taller, themed and completely personalised products.



Figurative expression of a familiar animal theme

Pájara

Canary Islands - Spain

This playground went for a spectacular look by creating highly figurative structures that strike a chord with the collective imagination, namely dinosaurs.

Featured in all shapes and sizes, these long-extinct but popular creatures bring extra magic to this playground in a city set against the backdrop of a seemingly lunar landscape.

Standing at 6.25 metres high, the large bespoke structure adjoins a Rainforest Tower, together forming the main attraction of this site, which truly takes children on a journey back in time.



Customised graphical design to inspire learning

Zoodyssée animal park

Villiers-en-Bois - France

The Zoodyssée animal park shines the spotlight on Europe's wildlife, while pursuing a set of educational and ecological aims.

This playground draws its inspiration from the scientific expeditions associated with the 'Canopy Raft' and encourages children to play at being botanists as they discover the Guyanese biodiversity.

The space features a central structure standing at seven metres high with an observatory offering 360-degree views and topped with an airship. Canoes and a platform transformed into a research laboratory for studying tropical plant and animal species add the finishing touches to the playground.

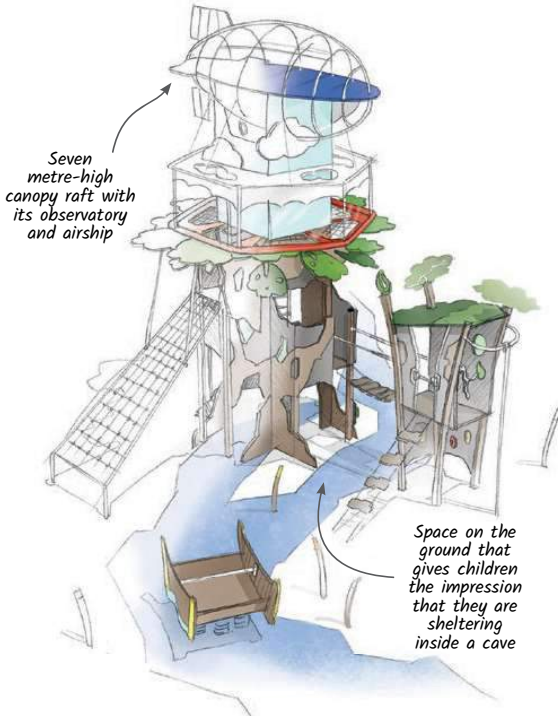

Discover the playgrounds at
the Zoodyssée animal park



*An architectural design
with poetic flair*

Vestertorv Square

Kolding - Denmark

This large structure engineered from Robinia wood resembles a cloud-inspired origami. Its natural colour and its interlocking repetitive geometric shapes produce a sleek architectural design.

Openings have been created in this three-dimensional space that follow the structure's lines, without ever overlapping, to guarantee a fascinating play of light and shadow.

This original structure is imbued with a sense of poetry and is guaranteed to fire the imagination in a city where nature's presence can be felt everywhere.



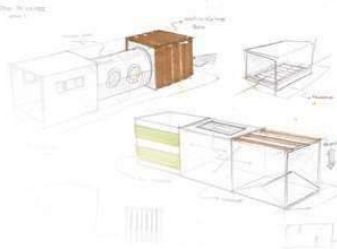
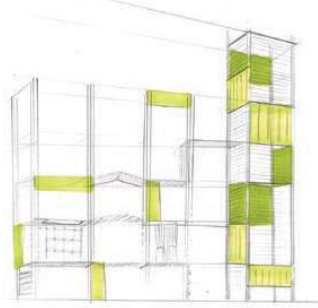

Harnessing and showcasing the local heritage

Friedrich Heinrich Colliery Park

Kamp-Lintfort – Germany

The playground has been installed at the city's former mining site, which has been turned into a museum paying tribute to the local industrial culture and the miners' work.

The play equipment is spread over three specific spaces allowing children to discover how the colliery extracted the coal while having fun in pretending to be the miners as they toiled underground. The large towers are replicas of the original buildings and shafts that can still be seen nearby.





*A wealth of information
is available on our website*

1/ Products and personal space

- **1,200 products** (specifications, 3D views, technical information, photos, videos, 2D DWG and 3D DWG files).
- **Your own personal space «My Account»** provides access to all the documents that may be useful when completing your Owner's Manual and allows you to quickly contact our customer service team.



#characteristics
#technical information

#2D DWG
and 3D DWG files

+ information
+ inspiration
on **PROLUDIC.COM**



#3D view

2/ Achievements and inspirations

- **Presentation of inspiring projects, designed and developed worldwide:**
 - According to the sector of activity: local authorities, landscape architects, holiday accommodation, healthcare facilities, etc.
 - According to themes and moods
 - Via case studies



Consult our
website for all
our play themes



3/ Thematic brochures and catalogues

A complete collection of brochures to support you with your projects.

Choose your theme:

- Inclusive play areas
- Bespoke play areas made to measure in Robinia
- Play for learning and teaching
- Special projects
- Grafic Games
- Safety



Request them from the website or from your area representative







MULTIPLAY EQUIPMENT

Diabolo & Diabolo Baby	20
Kanopé	40
Vivarea	64
Biibox	68
Ixo	72

Multiplay equipment is designed to make children move without them even realising!

For young children: the variety of play elements and how they're incorporated into the structures are designed to challenge their motor skills. At the same time, they encourage their curiosity and sense of discovery. For older children: there's an opportunity to put themselves to the test - to slide, climb, turn and cross - to go a little faster and take a few risks.

Multiplay equipment is all about getting children to be active. But it also has an important role in nurturing fun, joyful interactions between children by creating a place for a group of children to play together.



DIABOLO
MULTIPLAY EQUIPMENT



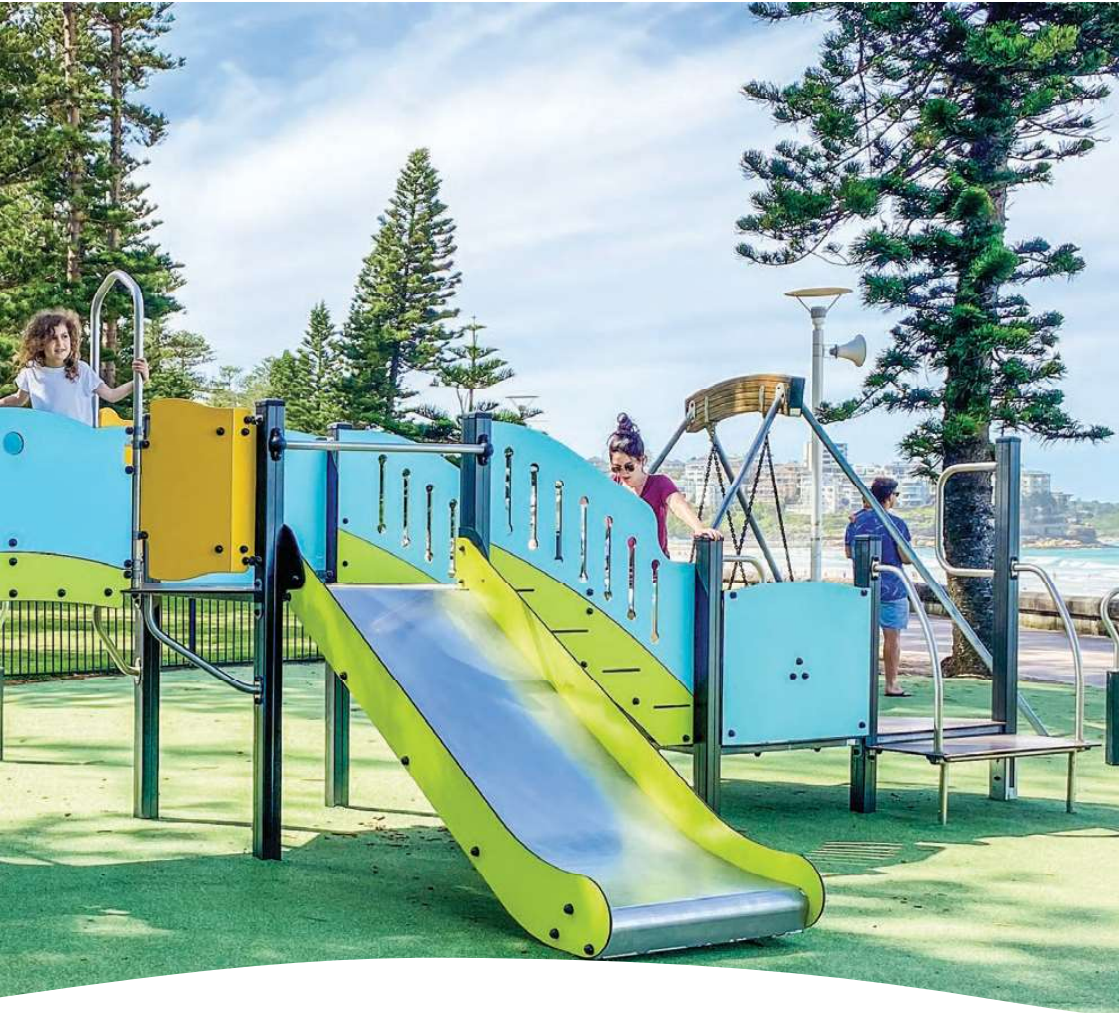

Diabolo is an essential component of any play area. With platforms ranging in height from 60cm to 177cm, and with many diverse play elements, the Diabolo range is suitable for children from 6 months to 12 years old.

The modular nature of this range allows for multiple combinations. These can be adapted to a specific age range, or used to encourage interaction between children with different capabilities due to age differences or abilities.

The classic 'must-have' play features are included on each structural element. Varied and complex on more elaborate combinations, these features offer children more opportunities to discover, be challenged and have fun.

Diabolo is available in two colour palettes: "Zingy" (yellow, orange and green) and "Pastel and Wood" (lagoon blue, apple green and oak).

DIABOLO BABY

MULTIPLAY EQUIPMENT



A range designed for toddlers

The Diabolo Baby range is dedicated to early childhood. The structures are designed to encourage early learning, guiding young children through a sequence of activities that stimulate their motor and fine-motor skills and support role-play and interaction with others.

All activities take place at ground level or a maximum height of 60cm. All play elements are varied, relevant, adaptable and modular.



Diabolo Baby, a range meeting the developmental and wellbeing needs of children from 6 months to 5 years:

Helping young children discover new motor skills

On all fours, children move forward in a confined space.



Moving forward on a slope, holding narrow shapes that are raised and spaced apart.

Moving in an area surrounded by empty space.

Going underneath.

Understanding obstacles



Developing their sensorimotor and psychomotor skills



Encouraging fine motor skills through the movement of shapes along a defined path.



Exploring how different objects look: colours, transparency, distorted reflections, light/dark contrasts.

Developing awareness of shapes (square, round, triangle)

Resolving play tasks using the manipulation of simple shapes that use thought, memory, learning and reasoning.

Experiencing different textures (raised diamond shapes, grass effect, rough surfaces).



Supporting their social development



Learning to play and interact with others.

Developing their imagination through role play

Encouraging children to help each other.



Climbing, sliding, crawling, sharing, inventing... GROWING!

DIABOLO BABY

MULTIPLAY EQUIPMENT

J38701®



0,5 +

1 m

5



J38701A*



J38701A-C*

J38701A

£4 026

J38701B

£4 026

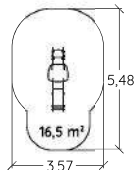
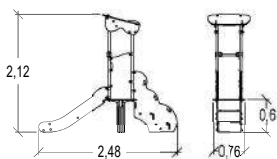

J38709®



0,5 +

<0,60 m

12



J38709A*



J38709A-C*

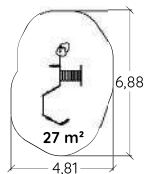
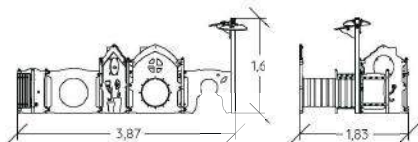

J38706®



0,5 +

1 m

12

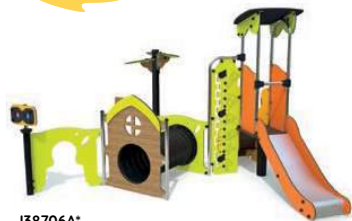

J38706A*



J38706A-C*

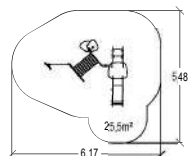
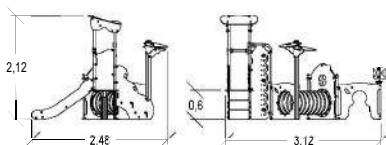

J38706A

£7 758

J38706B

£7 758

J38711®



0,5 +

1 m

12

J38711A

£7 880

J38711B

£7 880



J38711A*

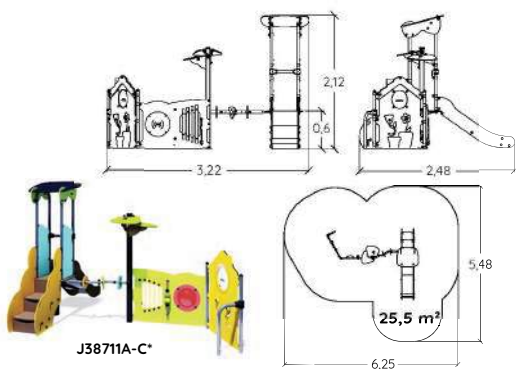

J38711A-C*



J38702®



0,5 +

1 m

12

J38702A

£8 717

J38702B

£8 717



J38702A*



J38702A-C*

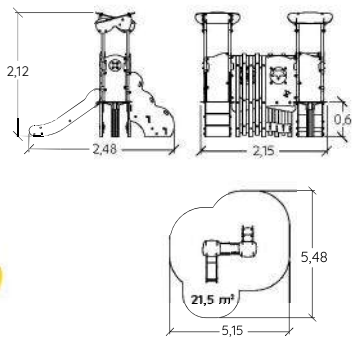

J38707-C®



0,5 +

1 m

20

J38707A-C

£9 441

J38707B-C

£9 441



J38707A-C*

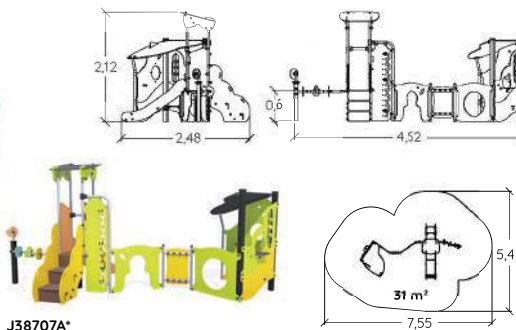

J38707A*



Compact composite panels

Stainless steel

Painted metal posts

*Pricing identical for both standard colour selections

DIABOLO BABY

MULTIPLAY EQUIPMENT



J38703-C*



0,5 +

1 m

13

J38703A-C

£10 830

J38703B-C

£10 830



J38703A-C*



J38703A*

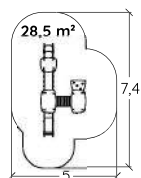
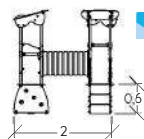
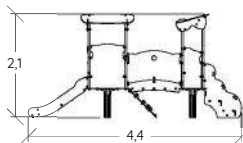

J38705-C*



0,5 +

1 m

19

J38705A-C

£12 697

J38705B-C

£12 697



J38705A-C*



J38705A*

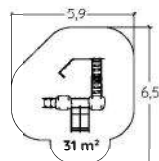
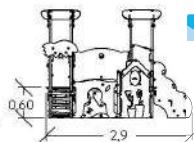
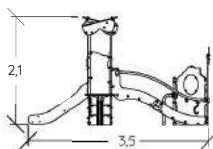

J38708-C*



2 +

1,17 m

28

J38708A-C

£18 669

J38708B-C

£18 669



J38708A-C*



J38708A*

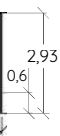
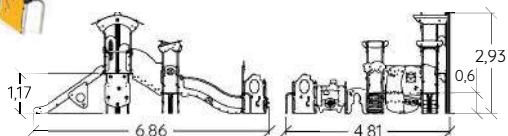
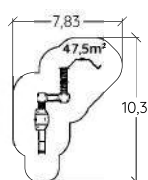

Compact composite panels

Stainless steel

Painted metal posts



DIABOLO

MULTIPLAY EQUIPMENT

J3850-C



2 - 10

1 m

12



J3850A-C	£5 348
J3850B-C	£5 348



J3850A-C*



J3850B-C*

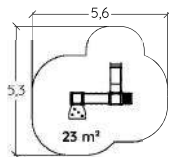
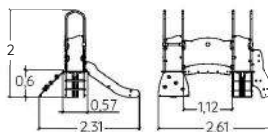

J3872-C



2 - 10

1 m

13

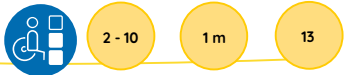

J3872A-C	£6 160
J3872B-C	£6 160



J3872A-C*



J3872B-C*

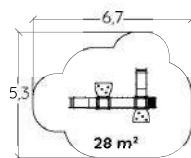
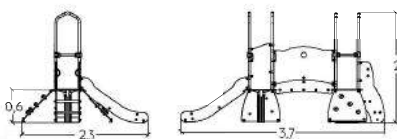

NEW

J38203®



2 +

1 m

12

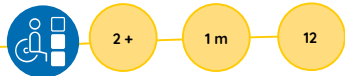

J38203A	£8 102
J38203B	£8 102



J38203A*



J38203B-C*

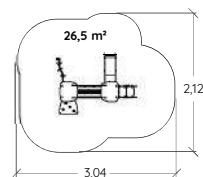
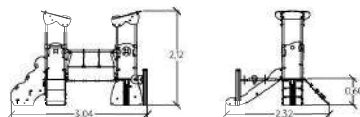

J3835-C



2 +

1,17 m

15

J3835A-C

£8 068

J3835B-C

£8 068



J3835A-C*



J3835A*

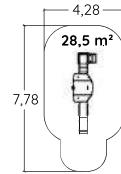
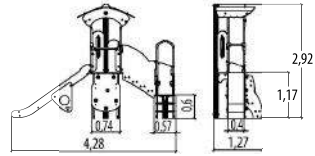

J3837



2 +

1,40 m

15

J3837A

£9 217

J3837B

£9 217



J3837A*



J3837A-C*

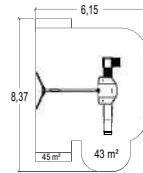
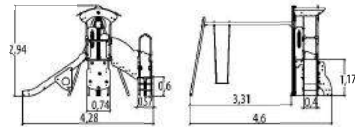

J38128



2 +

1,17 m

18

J38128A

£9 171

J38128B

£9 171



J38128A*



J38128A-C*

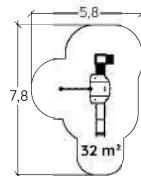
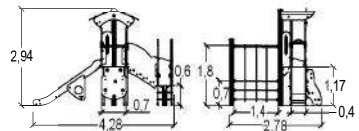

Compact composite panels

Stainless steel

Painted metal posts

*Pricing identical for both standard colour selections

DIABOLO

MULTIPLAY EQUIPMENT



J38124



2+

1,17 m

20

J38124A

£9 476

J38124B

£9 476



J38124A*



J38124A-C*

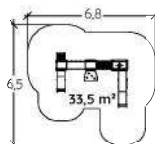
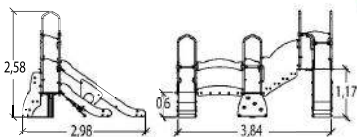

J38125



2+

1 m

12

J38125A

£9 802

J38125B

£9 802



J38125A*



J38125A-C*

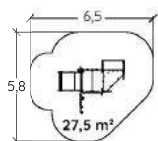
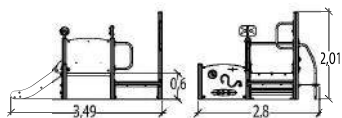

J38126



2+

1 m

15

J38126A

£10 856

J38126B

£10 856



J38126A*



J38126A-C*

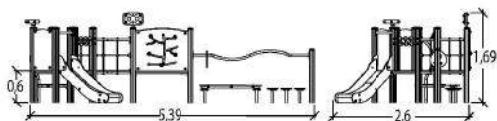
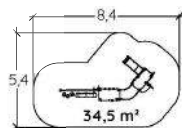

J3851-C



2 +

1,80 m

30

J3851A-C

£12 560

J3851B-C

£12 560



J3851A-C*

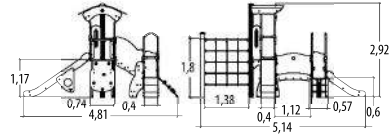

J3851A*

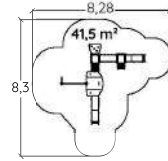

J3845



2 +

1,80 m

30

J3845A

£12 658

J3845B

£12 658



J3845A*

J3845A-C*

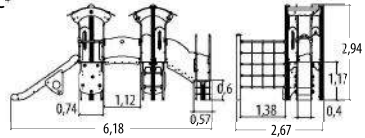
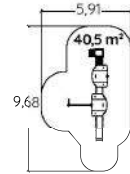

NEW

J3874-C*

2 +

2 m

15

J3874A-C

£12 923

J3874B-C

£12 923



J3874A-C*



J3874A*

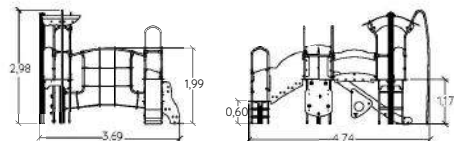
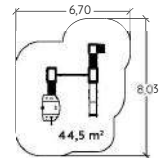

Compact composite panels

Stainless steel

Painted metal posts

*Pricing identical for both standard colour selections

DIABOLO

MULTIPLAY EQUIPMENT

J38119-C



2+

1 m

14



J38119A-C

£15 755

J38119B-C

£15 755



J38119A-C*

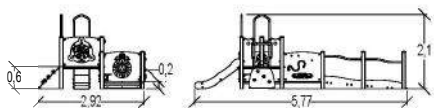

J38119A*

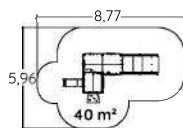

J38127



2+

1,37 m

18

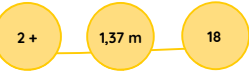

J38127A

£15 896

J38127B

£15 896



J38127A

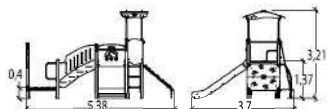

J38127A-C*

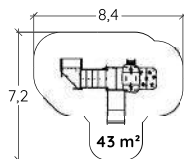

J38129-C



2+

1,17 m

19



J38129A-C

£17 167

J38129B-C

£17 167



J38129A-C*

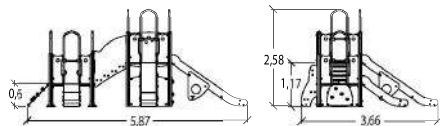

J38129A*

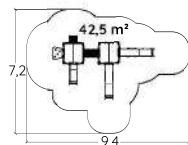

J3862-C



2+

1,80 m

35

J3862A-C

£17 266

J3862B-C

£17 266



J3862A-C

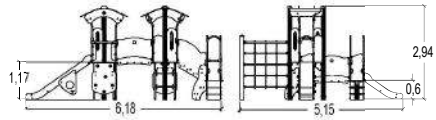

J3862A*

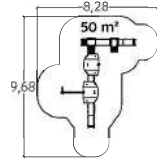

J38118



2+

1,80 m

25

J38118A

£23 320

J38118B

£23 320



J38118A*

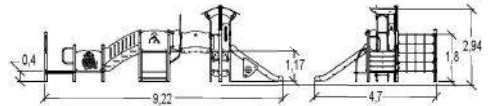

J38118A-C*

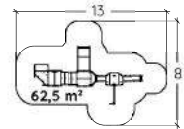

J38200



2+

1 m

33

J38200A

£24 564

J38200B

£24 564



J38200A

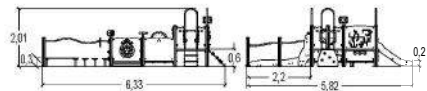

J38200A-C*

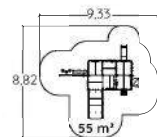

Compact composite panels

Stainless steel

Painted metal posts

*Pricing identical for both standard colour selections

DIABOLO

MULTIPLAY EQUIPMENT



J38201[®]



2+

1 m

37

J38201A

£30 122

J38201B

£30 122



J38201A*

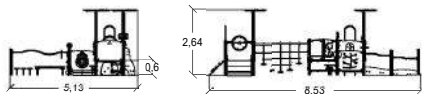

J38201A-C*

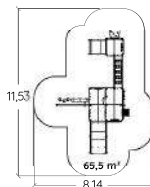

J38122



2+

1,37 m

25

J38122A

£43 115

J38122B

£43 115



J38122A*

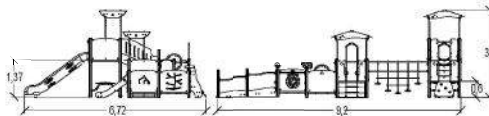

J38122A-C*

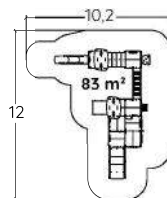

J3834-C

3+

2 m

19

J3834A-C

£6 376

J3834B-C

£6 376



J3834A-C*

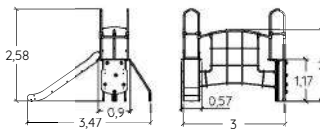

J3834A*

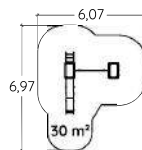

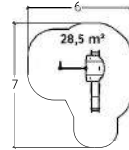
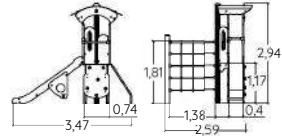
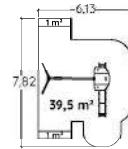
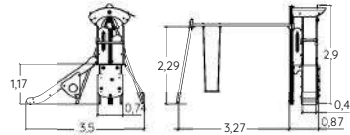
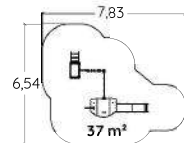
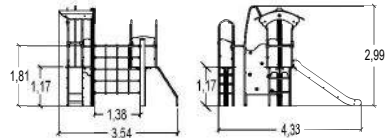
J3866**3 +****1,80 m****15****J3866A*****J3866A-C*****J3866A****£6 303****J3866B****£6 303****J3867-C****3 +****1,40 m****12****J3867A-C*****J3867A*****J3867A-C****£6 471****J3867B-C****£6 471****J3833****3 +****2 m****22****J3833A*****J3833A-C*****J3833A****£8 580****J3833B****£8 580**

Compact composite panels

Stainless steel

Painted metal posts

*Pricing identical for both standard colour selections

DIABOLO

MULTIPLAY EQUIPMENT



J3832-C

3 +

2 m

26

J3832A-C	£10 221
J3832B-C	£10 221



J3832A-C



J3832A*

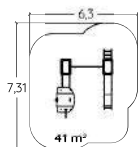
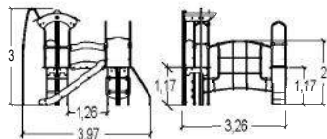

J3870



3 +

1,80 m

20

J3870A	£10 212
J3870B	£10 212



J3870A



J3870A-C*

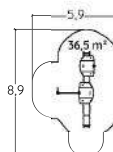
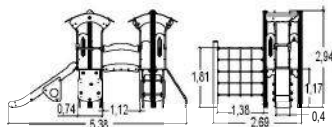

J38102-C

3 +

2,60 m

20

J38102A-C	£11 737
J38102B-C	£11 737



J38102A-C



J38102A*

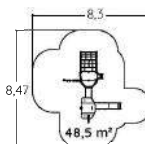
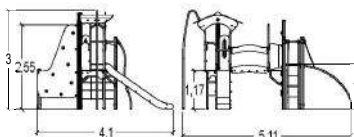

J38107

3 +

2,60 m

25

J38107A	£15 949
J38107B	£15 949



J38107A

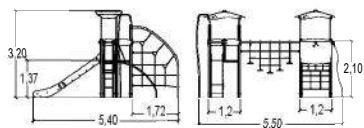

J38107A-C*

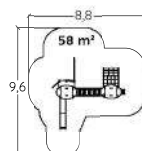
**J38131®**

3 +

2,40 m

20

J38131A	£16 713
J38131B	£16 713

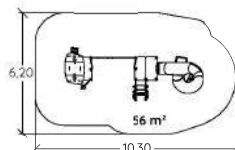
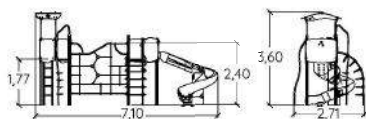

J38131A

**J38109-C**

3 +

2,60 m

32

J38109A-C	£21 934
J38109B-C	£21 934



J38109A-C

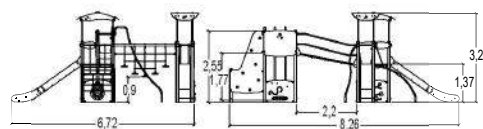

J38109A*

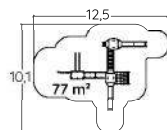

Find out more about the other 50 « Diabolo » products on our website.



Compact composite panels

Rotary moulded polyethylene

Painted metal posts

Stainless steel

*Pricing identical for both standard colour selections

Pro ludic

DIABOLO

MULTIPLAY EQUIPMENT







KANOPE
MULTIPLAY EQUIPMENT

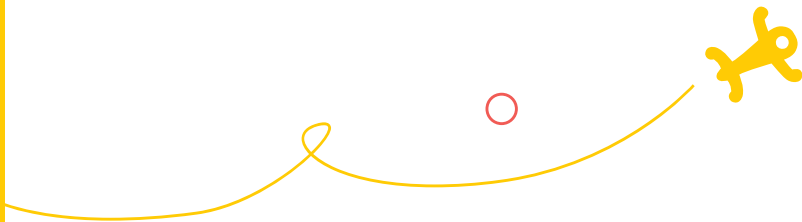



The Kanopé range, with its structures resembling wild grasses or tree trunks bent by the wind, invites children to venture into nature.

Children from two years of age can navigate a pathway that's horizontal or vertical, steep or moving. They can climb in all directions, clambering up and down numerous uniquely-shaped rope structures. They can pretend to be acrobats or tightrope walkers, or they can slide down a rope, a traditional slide, or take the plunge using the Speed Slide.

All play features fit with Kanopé's signature design - inspired by nature, with a contemporary, streamlined look.

The range is available in two styles: evergreen and oak effect.



J5602



2 +

1,17 m

10

J5602A

£10 076

J5602A-C

£10 903



J5602A



J5602A-C

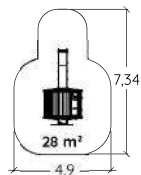
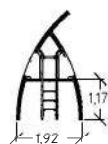
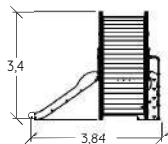

NEW

J5615®

2 +

1,17 m

15

J5615A

£11 918

J5615A-C

£12 619



J5615A



J5615A-C

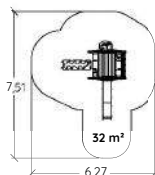
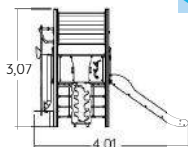
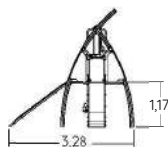

J5605



2 +

1,17 m

20

J5605A

£20 493

J5605A-C

£22 451



J5605A



J5605A-C

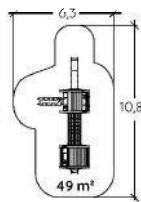
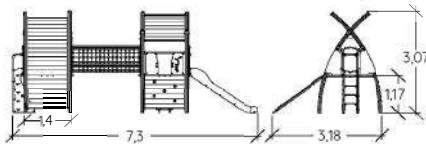

J5604



2 +

1,37 m

15

	J5604A	£20 635
	J5604A-C	£21 505



J5604A



J5604A-C

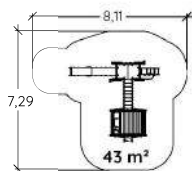
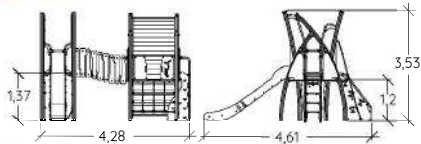

J5603

3 +

2,70 m

10

	J5603A	£7 072
	J5603A-C	£7 670



J5603A



J5603A-C

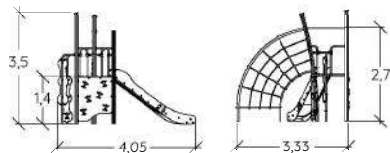
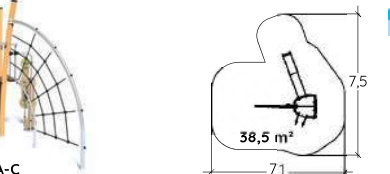

J5614-C®

3 +

2,32 m

23

	J5614A	£13 988
	J5614A-C	£14 632



J5614A-C



J5614A

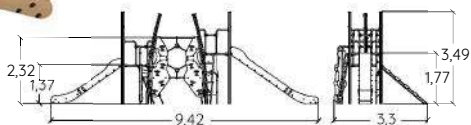
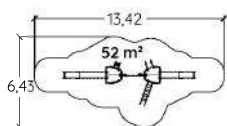

Compact composite panels

Stainless steel

Painted metal posts

Painted metal posts (Timber look colour)

NEW

J5616®



3 +



2,7 m



28

J5616A

£15 050

J5616A-C

£15 889



J5616A



J5616A-C

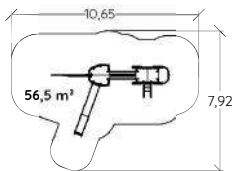
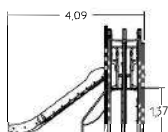
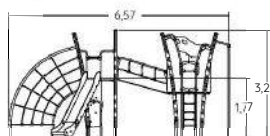

J5610

3 +

2,47 m

23

J5610A

£15 307

J5610A-C

£15 619



J5610A



J5610A-C

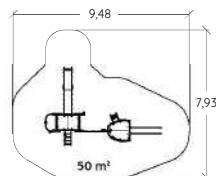
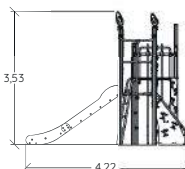
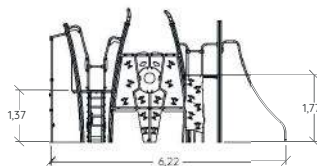



J5608

3 +

2,80 m

23

	J5608A	£17 465
	J5608A-C	£17 687



J5608A



J5608A-C

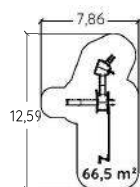
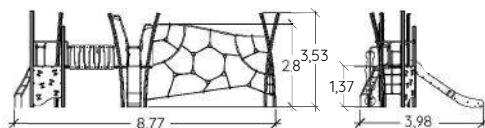



J5606-C®



3 +

1,37 m

23

	J5606A	£17 645
	J5606A-C	£17 898

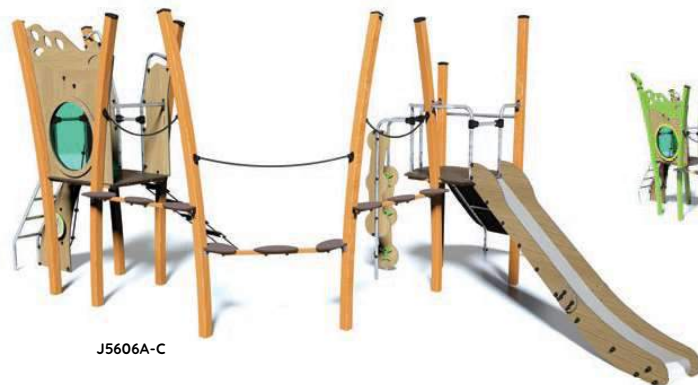

J5606A-C



J5606A

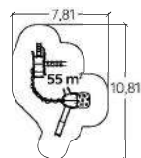
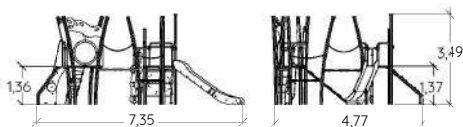

 Compact composite panels

 Stainless steel

 Painted metal posts

 Painted metal posts (Timber look colour)



J5609-C®

3 +

2,70 m

30

J5609A

£20 302

J5609A-C

£20 329



J5609A-C



J5609A

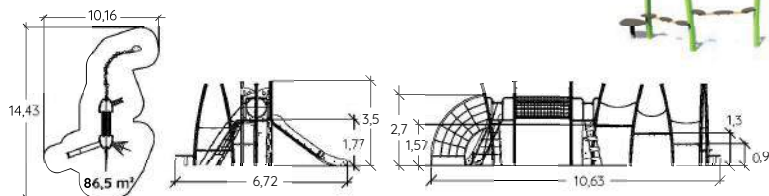

J57009



3 +

2,32 m

40

J57009A

£25 216

J57009A-C

£26 548

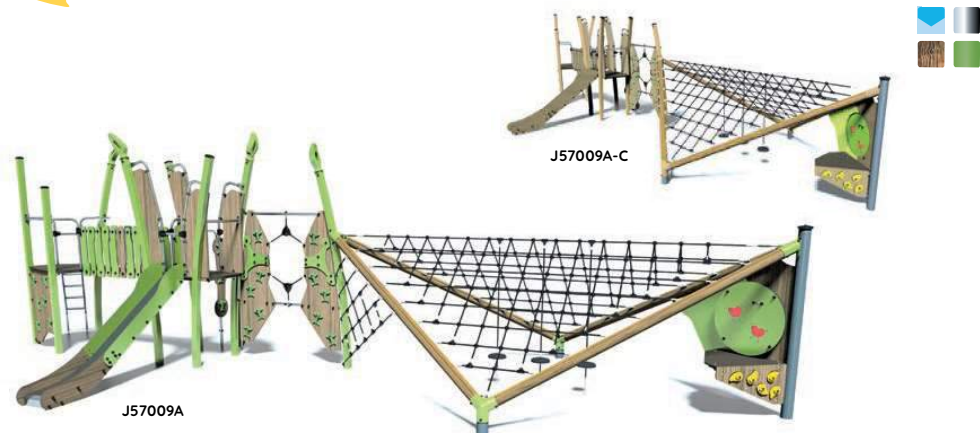

J57009A-C



J57009A

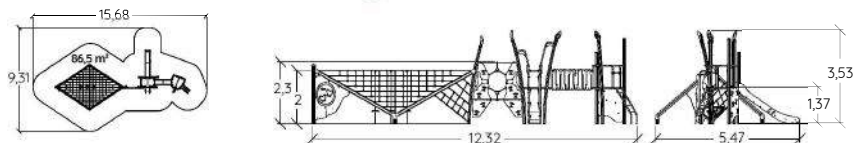

J5612

3 +

1,90 m

36

J5612A

£26 474

J5612A-C

£27 164



J5612A

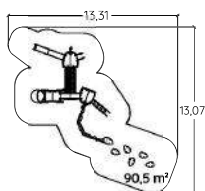

J5612A-C

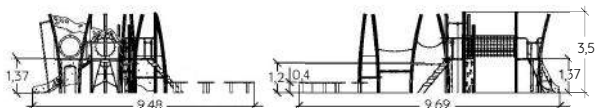

J5613

3 +

2,80 m

40

J5613A

£28 197

J5613A-C

£30 541

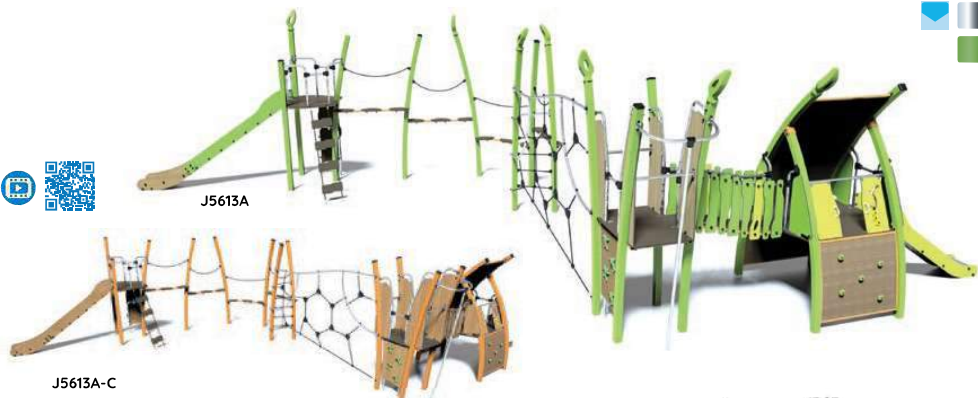

J5613A

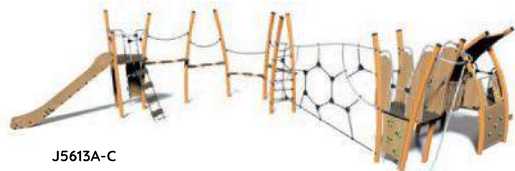

J5613A-C

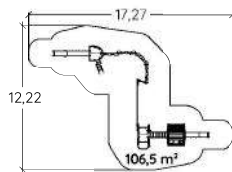
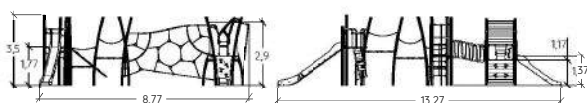

Compact composite panels

Stainless steel

Painted metal posts

Painted metal posts (Timber look colour)

Timber posts

KANOPE

MULTIPLAY EQUIPMENT



3 +



2,35 m



48

J57012A

£29 666

J57012A-C

£30 132

J57012



Version available
in stainless steel



J57012A-C

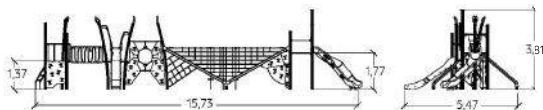
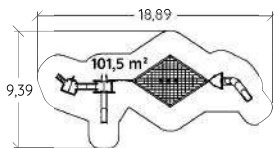

J5611



3 +

2,70 m

35

J5611A

£37 004

J5611A-C

£38 921

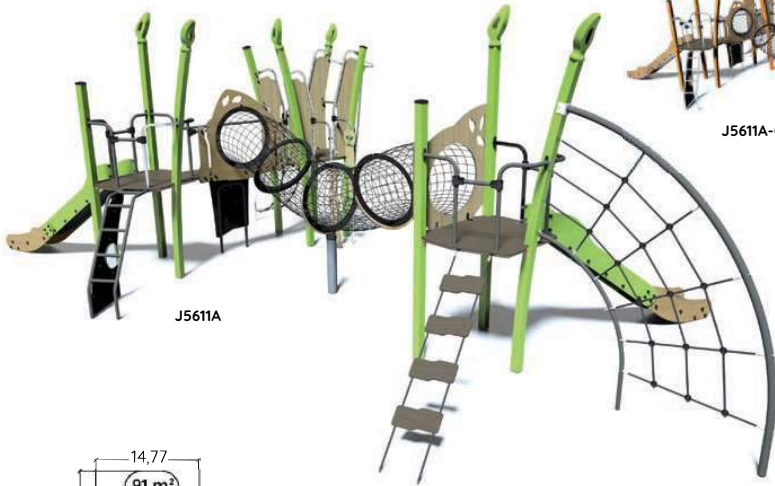

J5611A-C

J5611A

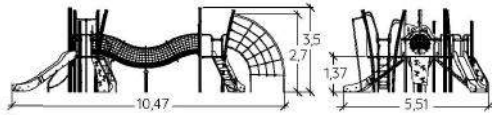
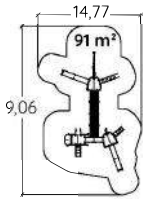

Compact composite panels

Stainless steel

Painted metal posts

Painted metal posts (Timber look colour)

Timber posts

KANOPE

MULTIPLAY EQUIPMENT

Since its introduction, the Kanopé range has continually evolved, offering new and ever more innovative play features.

2017

The range provides a new aesthetic environment, inspired by nature in a contemporary way.



Kanopé, the adventure continues under the treetops

2018

Kanopé reaches for the sky with its majestic towers, aerial and luminous, of up to 8m high.

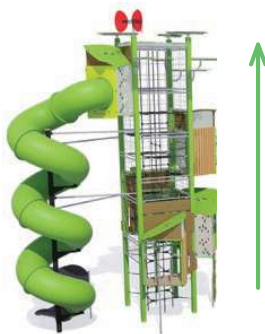

Kanopé, the adventure continues... higher, further... to other worlds

2021



Kanopé strengthens its range with new playful and inclusive structures designed for all age groups from the very young to older children: Ka'Yop Trees.



Kanopé, the adventure is played out inside, outside - everywhere





Proludic,
tell us the
story of
Ka'Yop!



Once upon a time...

In the Proludic Research & Development laboratory, our designers decided to create a new tree in the Kanopé family... Since Kanopé is in blossom all year round, they extracted a tiny seed, studied it, removed its outer shell, transformed it, enriched it, then decided to plant it...



A few months later, watered with reflection, consideration and consultation... enhanced through trials and tests... the tiny seed awoke from dormancy, germinated, emerged from the ground and grew into... Ka'Yop.

The different varieties of Ka'Yop trees:



Ka'Yop Essential,
Ka'Yop Dynamic,
Ka'Yop Inclusive,
Maxi Ka'Yop,
Ka'Yop Spiral

Discover the story in
video of how Ka'Yop
trees were created



KA'YOP

FULL OF SECRETS INSIDE, OUTSIDE - EVERYWHERE

Ka'Yop is an enchanted tree that will delight both children and teens with its wealth of exciting play activities.

The lower part contains collaborative and inclusive play elements. Play panels, sound-play, climbing nets, moving seats and rotating play features are spread over the 4 structures.

The upper part, with its lush green foliage, transforms the tree into a leafy cocoon, containing a wide variety of motor and sensory activities.

KANOPE - KA'YOP TREES

MULTIPLAY EQUIPMENT

J56004®



2+

1,17 m

14

Ka'Yop Inclusive

J56004A

£26 252

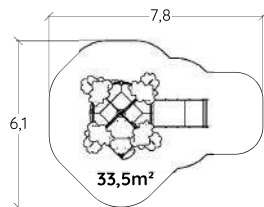
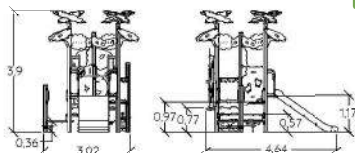

J56003-GA®



2+

3 m

32

Maxi Ka'Yop

J56003A-GA

£52 996

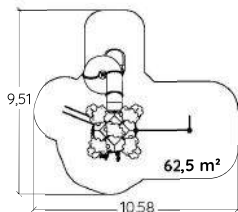
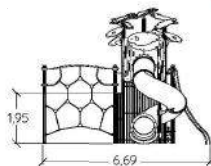
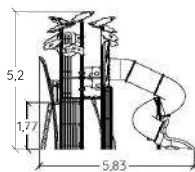

J56005®



3 +

2,37 m

24

Ka'Yop Spiral

J56005A

£27 451

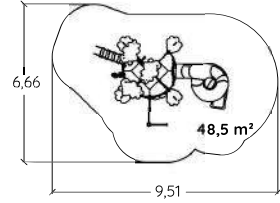
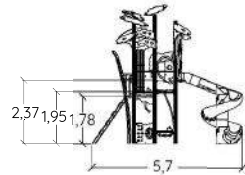
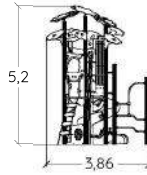

J56002®



3 +

2,70 m

29

Ka'Yop Dynamic

J56002A

£28 716

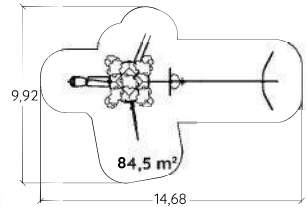
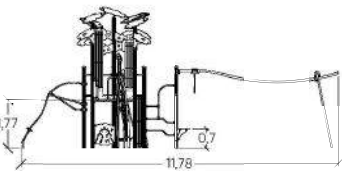
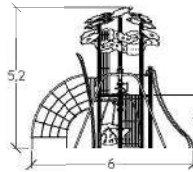

 Compact composite panels

 Stainless steel

 Painted metal posts

Get in touch
to create your bespoke
Ka'Yop combination.



KANOPE - THE TALL TOWERS

MULTIPLAY EQUIPMENT





These majestic tall towers, as high as 8 metres, will make an impact in any environment.

Children can climb a rope staircase to reach asymmetric play houses perched high at the top of the towers - giving each child a commanding view and a special space above the action.

A large 'Kayak' spiral slide guarantees a thrilling ride all the way back down.

KANOPE - THE TALL TOWERS

MULTIPLAY EQUIPMENT

J56100



5 +



2,56 m



25

J56100A

£62 829

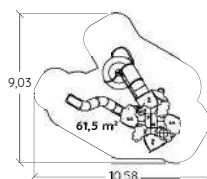
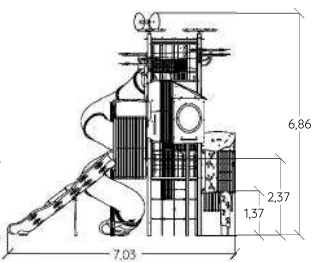
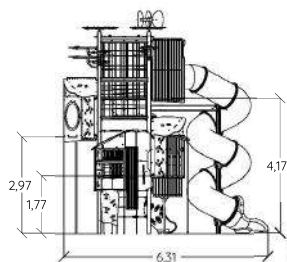

J56104

5 +

2,87 m

44

J56104A

£75 413

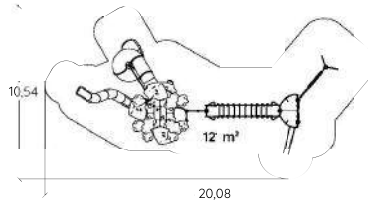
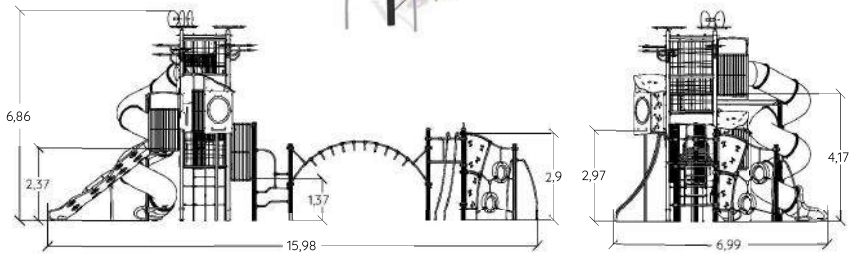
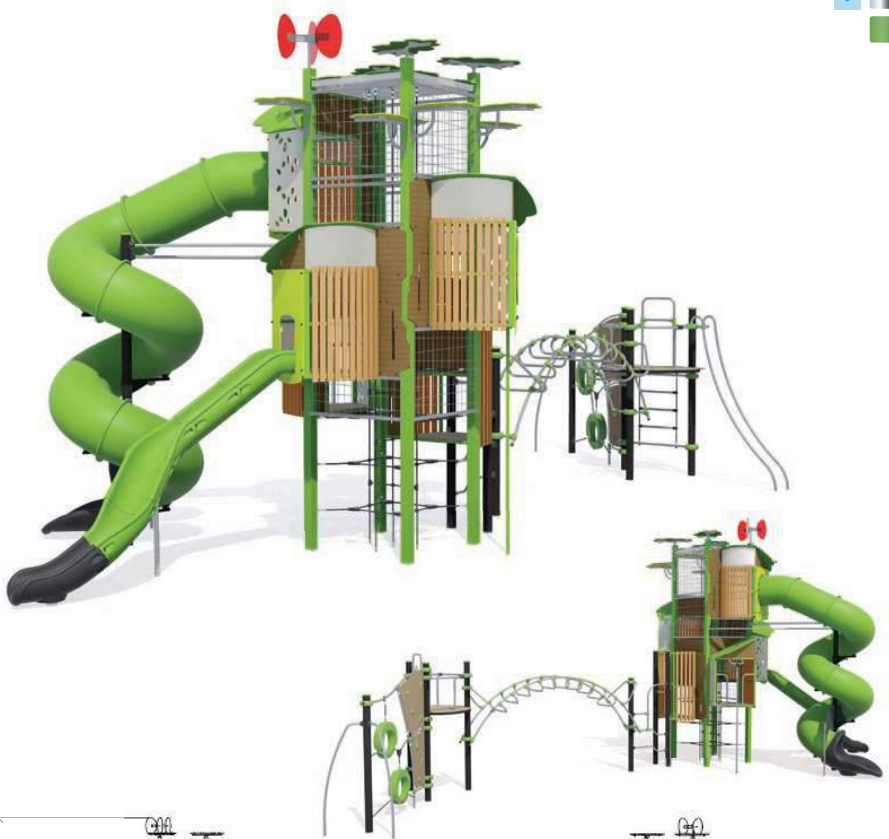

 Compact composite panels

 Stainless steel

 Painted metal posts

KANOPE - THE TALL TOWERS

MULTIPLAY EQUIPMENT



5 +



2,16 m



55

J56101

J56101A

£123 156

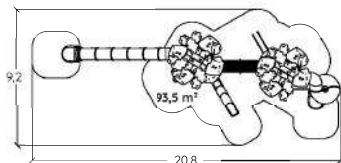
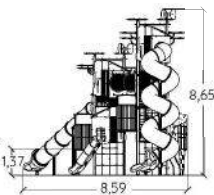
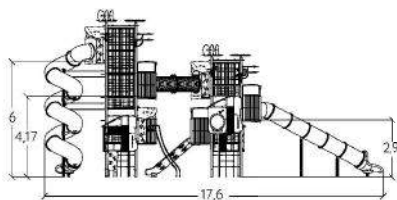

J56103

5 +

2,37 m

54

J56103A

£140 098

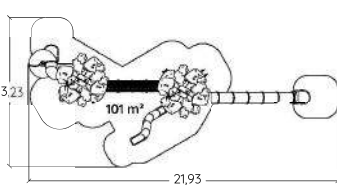
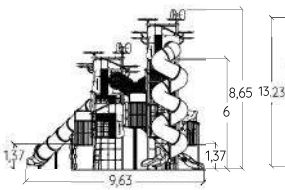
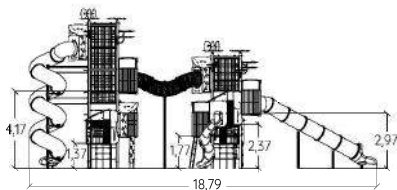

Compact composite panels

Stainless steel

Painted metal posts

KANOPE - A MODULAR RANGE

MULTIPLAY EQUIPMENT



J56102

3 +

2,80 m

67

J56102A

£88 601

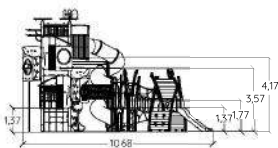
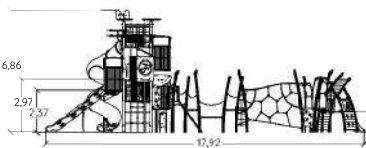
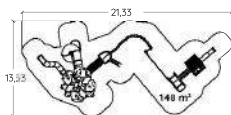

J56105



5 +

2,10 m

55

J56105A

£89 839

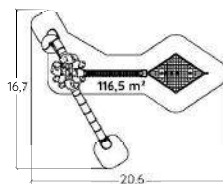
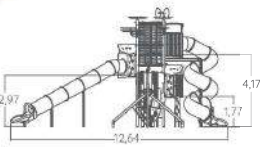

2 examples of Ka'Yop structures able to connect with other Proludic ranges

Sample multi-age combination

- ⊕ From 2 years
- ⊕ For a wide age range
- ⊕ 31 play activities
- ⊕ Up to 75 children

Large Kanopé tower

- ⊕ A towering 6m high structure with spiral slide and climbing net

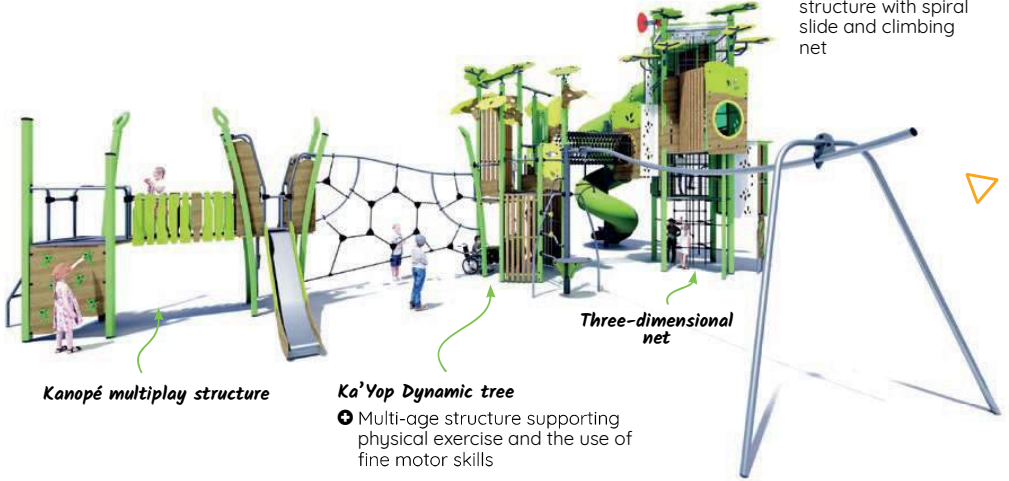

- ⊕ Multi-age structure supporting physical exercise and the use of fine motor skills

Sample combination for young children

- ⊕ From 2 years
- ⊕ 27 play activities
- ⊕ Multiple ground-level activities
- ⊕ Up to 28 children



Compact composite panels



Stainless steel



Painted metal posts



Timber posts

KANOPE

MULTIPLAY EQUIPMENT







VIVAREA
MULTIPLAY EQUIPMENT





The Vivarea range provides a variety of interesting and stimulating play activities for children aged 2 to 8 years, in a style that captures the sunny European climate.

The structures take their inspiration from Mediterranean villages nestled into the mountains, with varied levels, spaces, shapes and heights.

Semicircular terraces, narrow, straight walkways, clever variations in platform levels, closed or open playhouses; the equipment can be used by large numbers of children and it provides them with lots of activities to enhance learning and motor skills.

The equipment range comes in a variety of combinations, with key opportunities for play and development, providing suitable options for small or larger play areas alike.



J3301



2 - 8

1,17 m

10



J3301A	£8 462
J3301B	£8 462

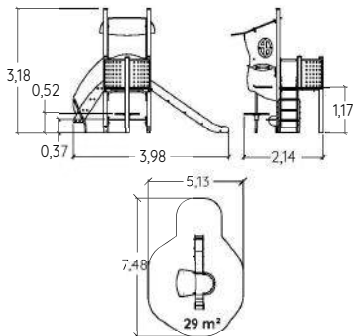

J3302



2 - 8

1,17 m

17



J3302A	£13 409
J3302B	£13 409

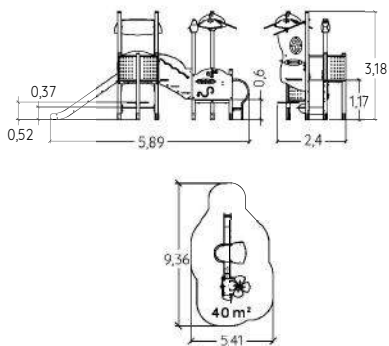

J3338



2 +

1,70 m

27



J3338A	£10 110
J3338B	£10 110

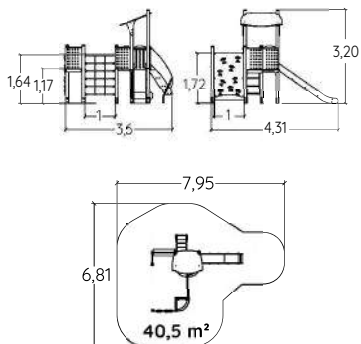

J33111



2 +

1,17 m

30

J33111A

£15 846

J33111B

£15 846

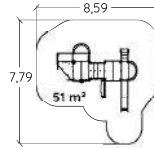
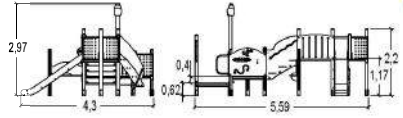

J3358



2 +

1,70 m

30

J3358A

£16 146

J3358B

£16 146

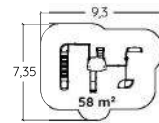
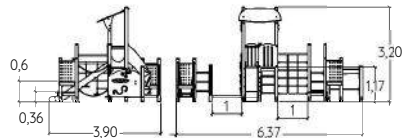

J3359



2 +

1,70 m

30

J3359A

£17 725

J3359B

£17 725

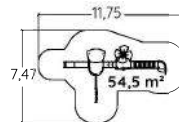
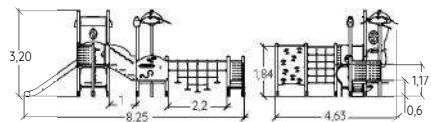

Find out more about the other 14 « Vivarea » products on our website.





BIIBOX
MULTIPLAY EQUIPMENT

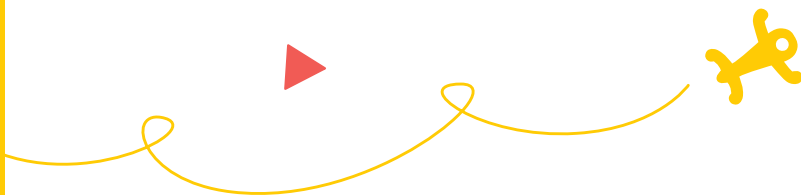



Designed like a town, the play area provides a meeting point for children aged 2 to 12 years who want to test and develop their motor skills. This provides opportunities for children who are eager to find excitement, adventure and other children to talk to and socialise with.

The style of the Biibox range is contemporary, with a look that combines flowing curves utilising predominantly metal materials, highlighted by brightly coloured panels.

Its modular design allows a solution to be found for all requirements and enables it to fit effortlessly into the surrounding environment.

BIIBOX

MULTIPLAY EQUIPMENT



J45202



2 - 8

1,17 m

27

J45202A

£24 890

J45202B

£24 890

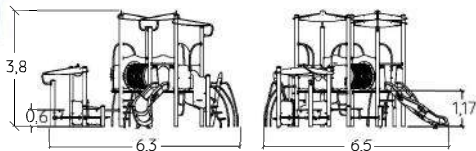
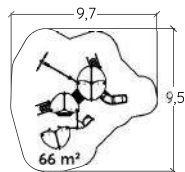

J45416



2 +

3 m

35

J45416A

£29 189

J45416B

£29 189

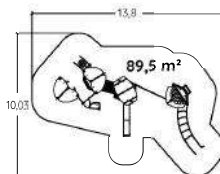
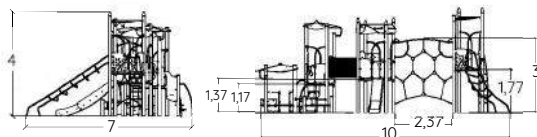

Find out more about the other 37 « Biibox » products on our website.



J45417



3 +

2,90 m

45

J45417A

£51 467

J45417B

£51 467

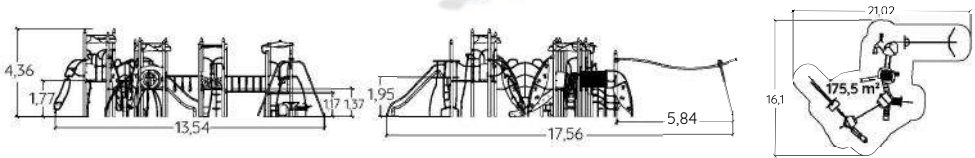

J45206

4 +

2,90 m

15

J45206A

£13 721

J45206B

£13 721

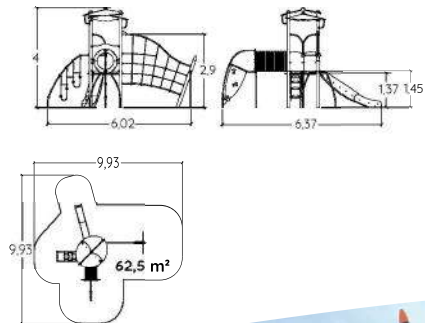

Compact composite panels

Stainless steel

Painted metal posts



IX0
MULTIPLAY EQUIPMENT





The Ixo range speaks the language of pre-teens.

No longer satisfied with playing the same games as younger children, pre-teen want to be challenged - to test their strength, to prove themselves in the eyes of others, to make their own rules.

Inspired by modern architecture, the Ixo range is contemporary in style, with clean lines and transparent structures.

The range is available in two styles – choose from metal or wooden posts - to create a more urban or more natural effect.



6 +



1,95 m



14

■	J2541A-M	£8 955
■	J2541A	£8 384

J2541-M

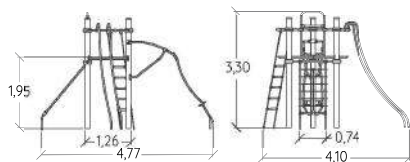
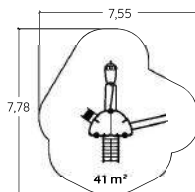

J2534-M

6 +

2,5 m

12

■	J2534A-M	£9 087
■	J2534A	£8 512

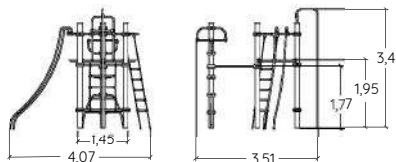
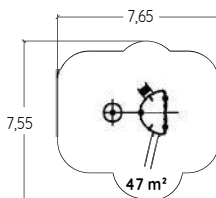

J2533-M

6 +

3 m

20

■	J2533A-M	£12 101
■	J2533A	£11 772

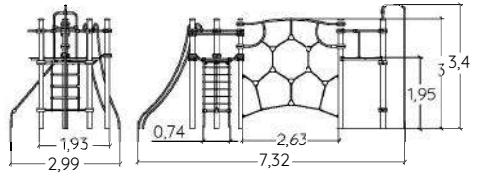
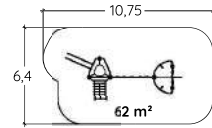
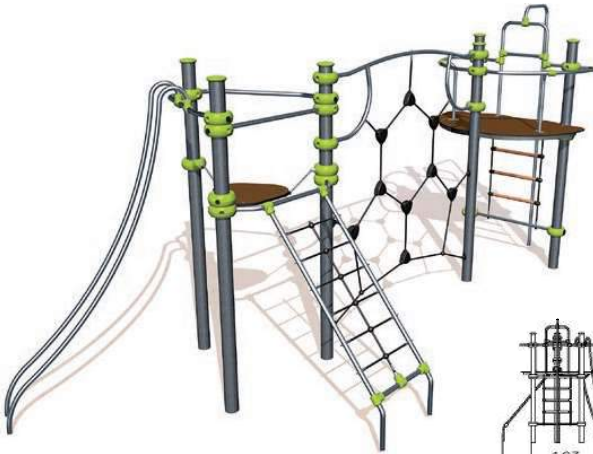

J2537-M

6 +

2,40 m

17

■	J2537A-M	£13 358
■	J2537A	£12 507

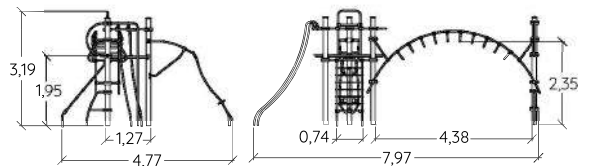
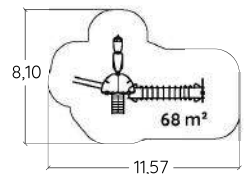

■ Stainless steel

■ Painted metal posts

■ Timber posts



J2586-M

6 +

2,90 m

18

J2586A-M

£16 910

J2586A

£15 784

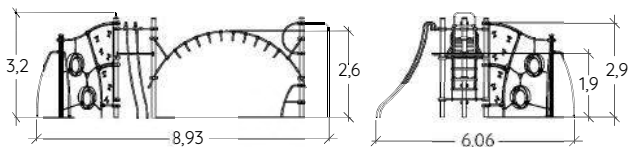
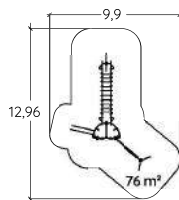

J2536-M

6 +

2,4 m

19

J2536A-M

£18 106

J2536A

£16 953

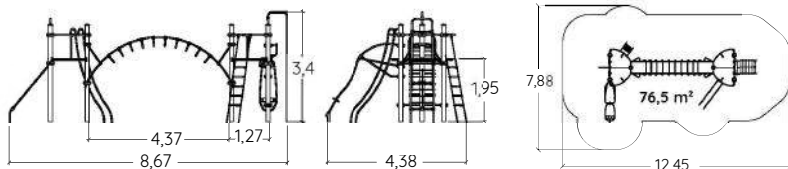
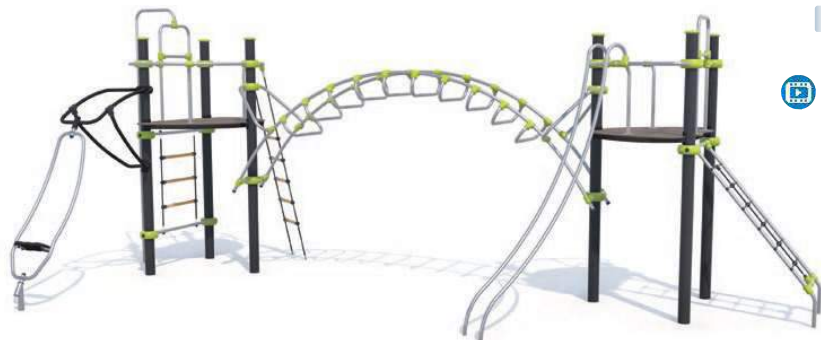

J2583-M

6 +

2,20 m

18

■ J2583A-M

£20 474

■ J2583A

£19 597

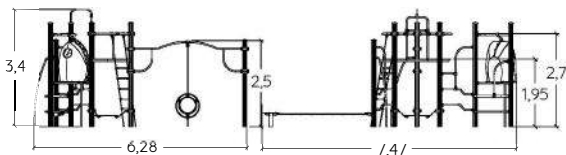
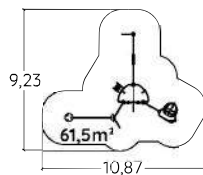

J2580-M

6 +

2,72 m

19

■ J2580A-M

£20 762

■ J2580A

£19 394

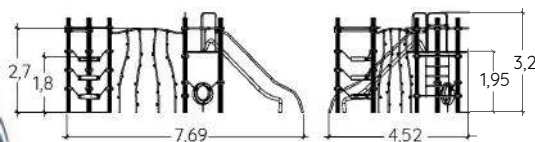
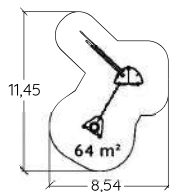

■ Stainless steel

■ Painted metal posts

■ Timber posts



J2578-M

6 +

2,72 m

20

J2578A-M

£21 646

J2578A

£21 120

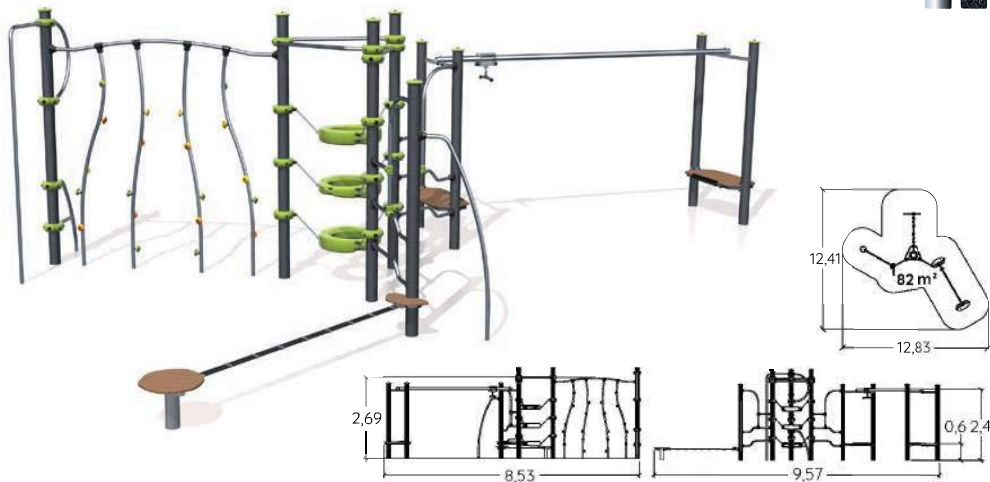

J2538-M

6 +

3 m

28

J2538A-M

£22 563

J2538A

£22 025

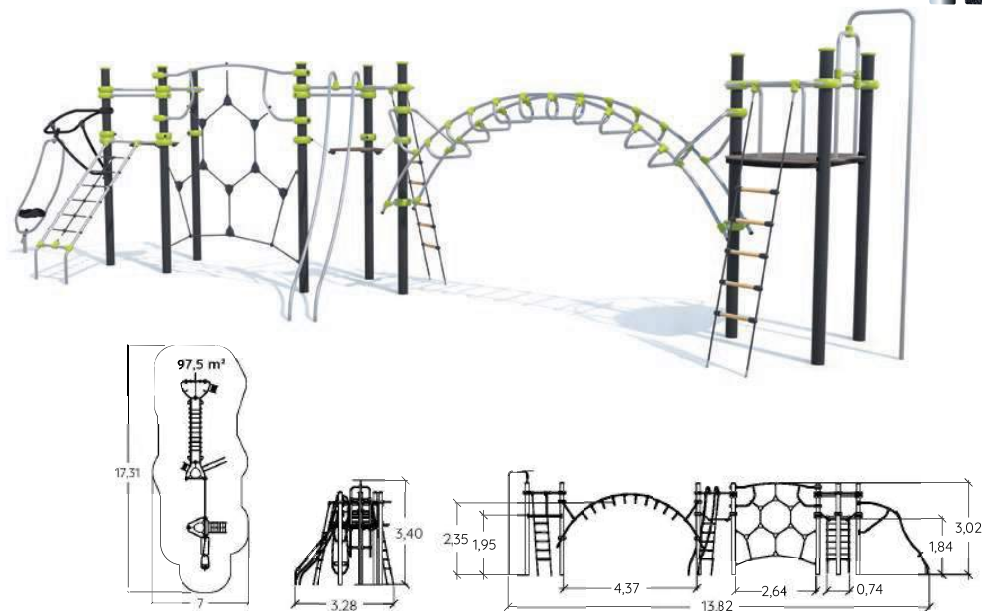

J2532-M

6 +

3 m

22

J2532A-M
J2532A

£22 774
£22 900

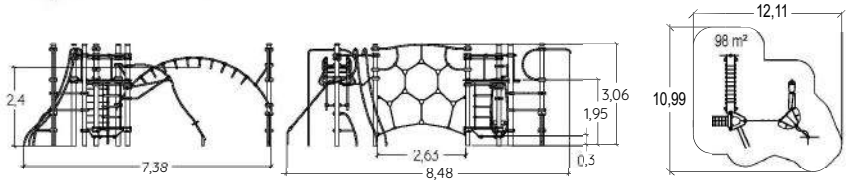

J2579-M

6 +

1,95 m

24

J2579A-M
J2579A

£36 520
£33 324

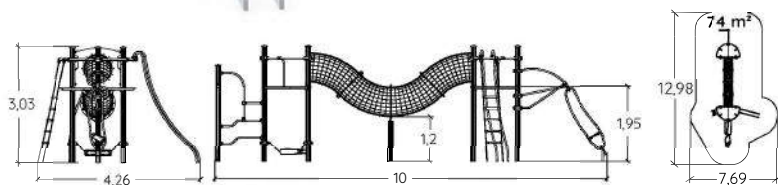

Stainless steel

Painted metal posts

Timber posts

J2587-M



6 +



2,87 m



28

J2587A-M

£40 968

J2587A

£37 774

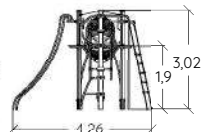
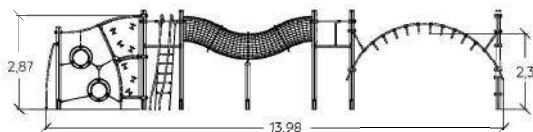
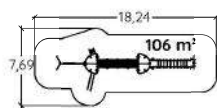

J2535-M

8 +

2,40 m

14

J2535A-M

£9 882

J2535A

£9 617

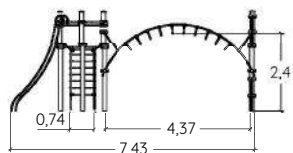
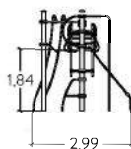
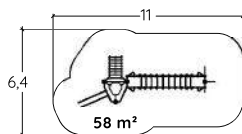
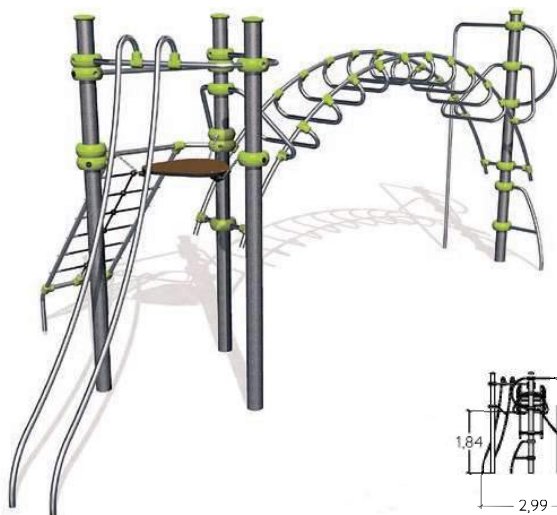

J2584-M

8 +

2,90 m

14

■	J2584A-M	£11 580
■	J2584A	£11 141

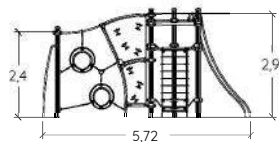
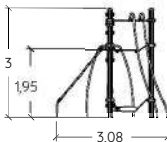
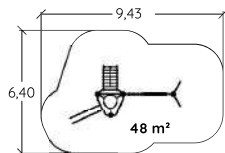

J2523-M

8 +

2,40 m

15

■	J2523A-M	£12 613
■	J2523A	£12 267

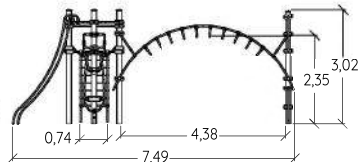
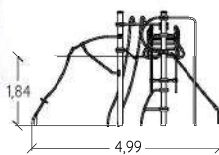
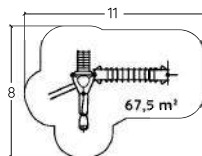

+ Find out more about the other 45 « Ixo » products on our website.



■ Stainless steel

■ Painted metal posts

■ Timber posts





THEMED EQUIPMENT

Adventure	84
Metropolis	98
City	106
Aquatica	120
Medieval	128

Our themed play equipment fires up the imagination. Children can dream of being adventurers on boats, trains, rockets and fire engines. They can imagine lions and dinosaurs. They can create their own world around our playspace themes: Adventure, Metropolis, City, Aquatica and Medieval.

They can express themselves freely, stimulated by the many details and unique elements on every piece of equipment.



ADVENTURE
THEMED EQUIPMENT





Our Adventure-themed equipment transports children into the leafy undergrowth of the jungle. Whether climbing aboard a jeep or carefully crossing the suspension bridge, young explorers can go in search of a secret temple and come face-to-face with wild animals along the way.

Each structure is equipped with a range of play elements that challenge and stimulate the senses.

The use of an orange, brown and green colour palette, emphasises the tropical forest theme.



J2636-M



2+

1,17 m

12

Amazonia

J2636A-M	£8 286
J2636B-M	£8 286

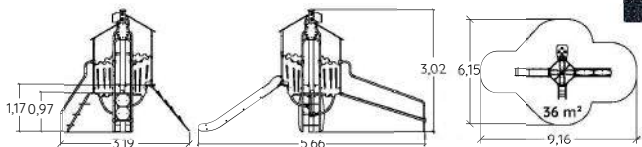

J2633-M

3+

1,30 m

11

Amazonia

J2633A-M	£7 460
J2633B-M	£7 460

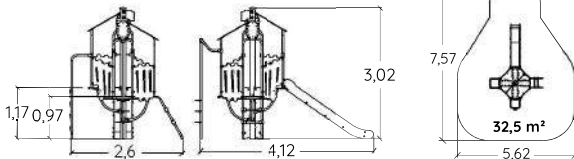

J4051



2+

1 m

10

Tawny Owl

J4051A	£4 444
J4051B	£4 444

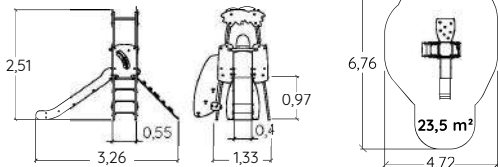

J4031®



2+

1 m

12

Leo and the Tawny Owl

J4031A	£6 533
J4031B	£6 533

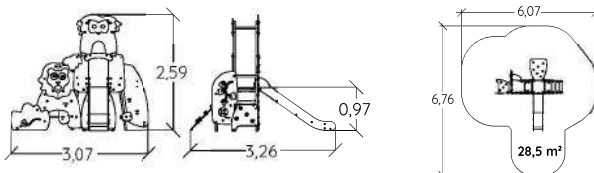

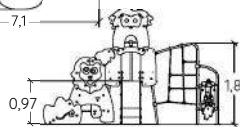
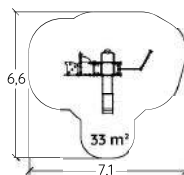
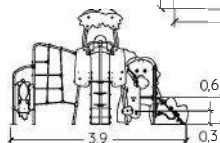
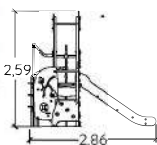
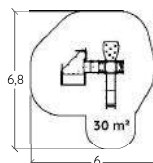
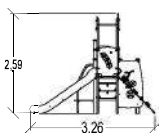
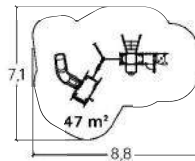
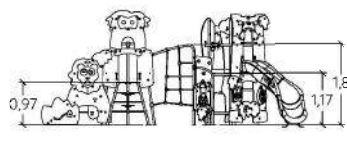
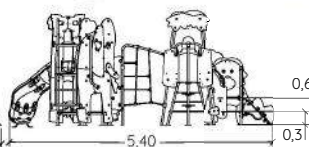
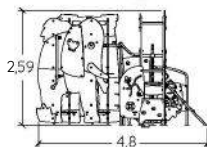
J4061**2 +****1,80 m****16***Big Tawny Owl***J4061A** £9 621**J4061B** £9 621**J4021****2 +****1 m****14***Inclusive Tawny Owl***J4021A** £9 882**J4021B** £9 882**J4081****2 +****1,80 m****25***Jungle***J4081A** £19 688**J4081B** £19 688

Compact composite panels

Stainless steel

Galvanised steel

Painted metal posts



Jeep

J2614



2 - 6

0,35 m

4

J2614A

£1 393

J2614B

£1 393

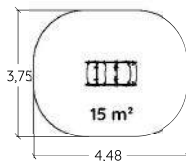
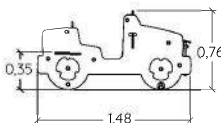
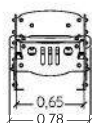

J2613



2 - 6

0,90 m

4

Suspension Bridge

J2613A

£1 757

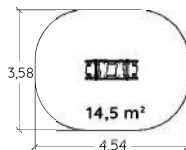
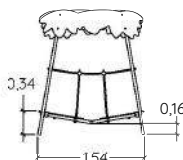

J2623®

2 - 6

0,60 m

5

Tractor

J2623A

£4 283

J2623B

£4 283

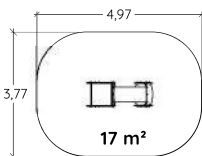
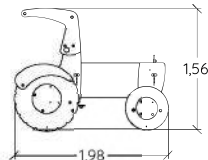
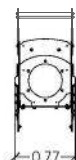

J2626®



0,5 +

1 m

5

The Crooked House

J2626A £3 292

J2626B £3 292

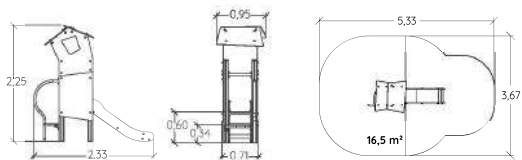

J2625®



2 +

1,60 m

25

The Crooked Hamlet

J2625A £17 454

J2625B £17 454

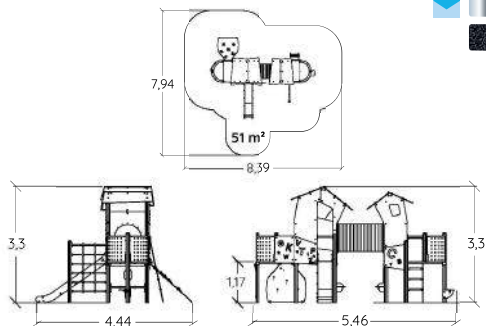

J2624®



2 +

1 m

25

The Crooked Village

J2624A £18 265

J2624B £18 265

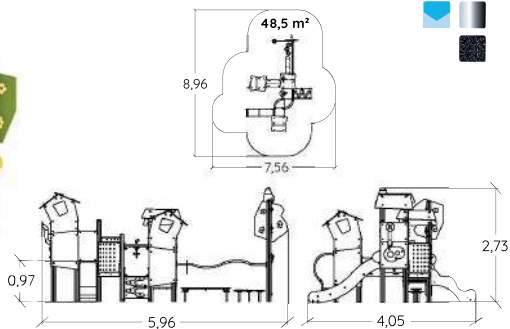

Compact composite panels

Stainless steel

Galvanised steel

Painted metal posts

ADVENTURE THEMED EQUIPMENT

J38502



2 - 10



1 m



12

J38502A

£7 429

J38502B

£7 429

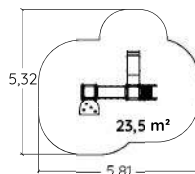
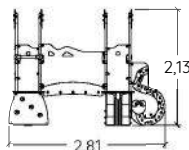
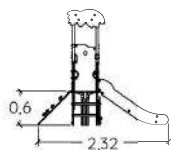

J38501



2 +

1,17 m

15

J38501A

£11 050

J38501B

£11 050

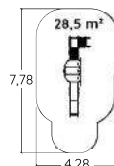
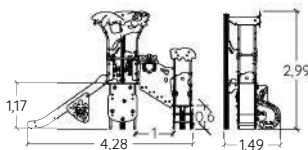

J38504



2 +

1,80 m

18

J38504A

£11 911

J38504B

£11 911

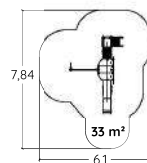
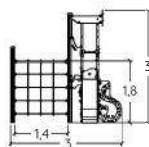
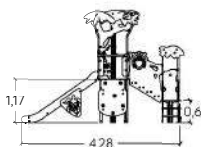

J38503



2 +

1,80 m

30

J38503A

£15 976

J38503B

£15 976

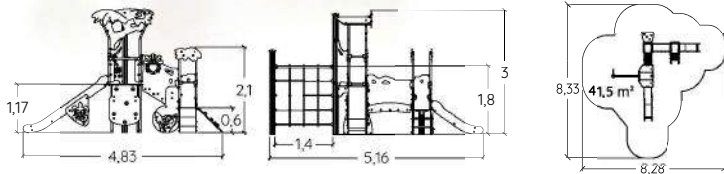

J38553®



2 +

2,60 m

32

J38553A

£37 890

J38553B

£37 890

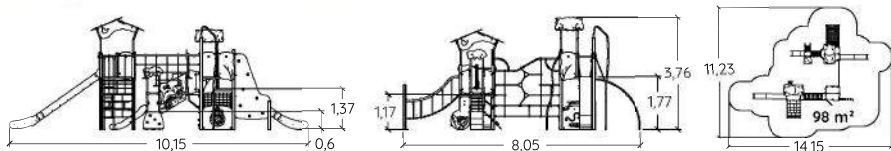

Compact composite panels

Stainless steel

Painted metal posts

ADVENTURE THEMED EQUIPMENT



J38551

3 +

2,60 m

15

J38551A	£11 569
J38551B	£11 569

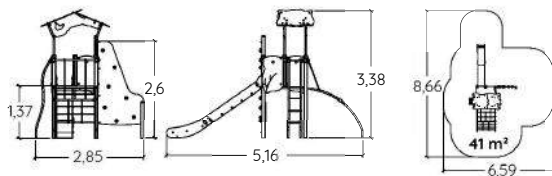

J38550

3 +

2 m

15

J38550A	£16 452
J38550B	£16 452

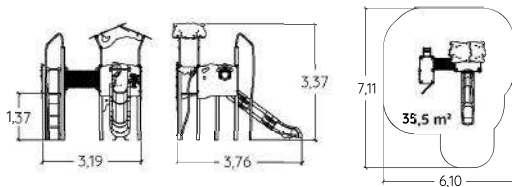

J38552

3 +

2,60 m

22

J38552A	£16 976
J38552B	£16 976

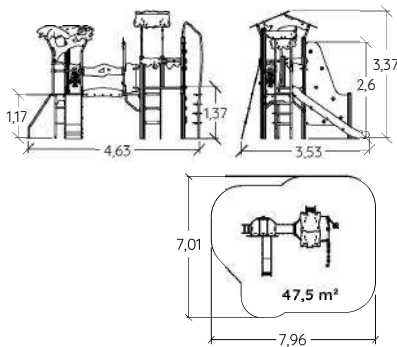

J2683®

3 +

2,37 m

30

The Tree Top Tower

J2683A

£29 005

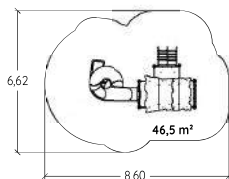
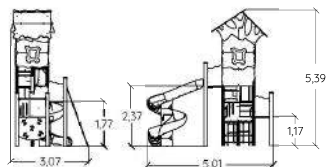

J2687

3 +

2,60 m

32

Nature Tower

J2687A

£36 114

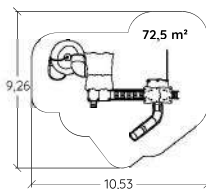
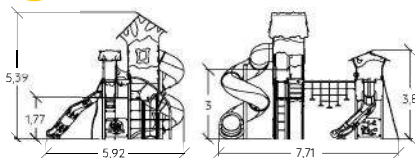

Compact composite panels

Stainless steel

Painted metal posts

Rotary moulded polyethylene

ADVENTURE THEMED EQUIPMENT



3 +



2,37 m



48

The Forest Tower

J2688A

£79 582

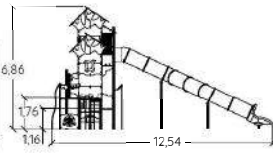
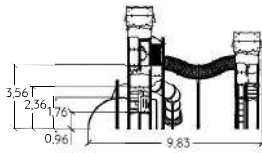
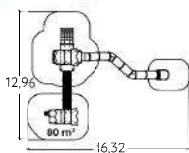

J2770

4 +

2,60 m

23

Dino

J2770A

£20 376

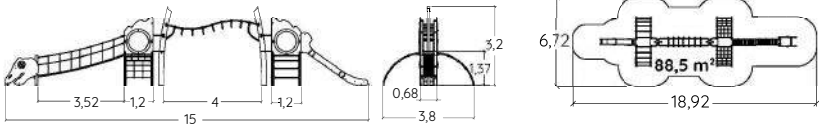

J2771

4 +

2,60 m

23

Crocodile

J2771A

£21 103

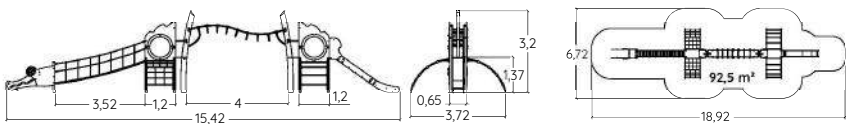
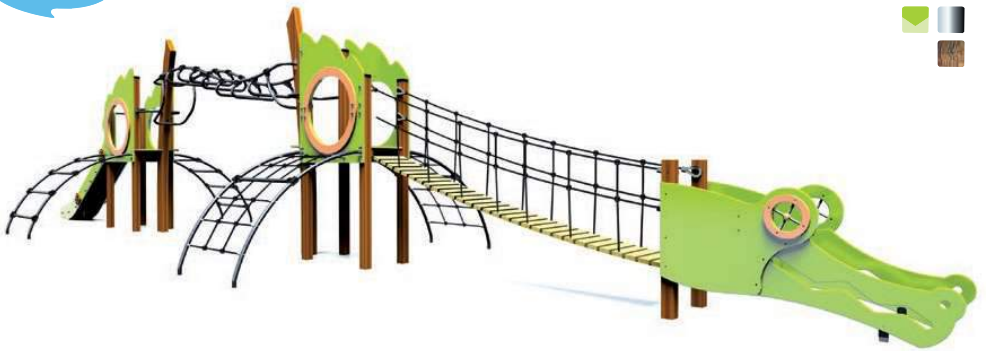

Find out more about the other 13 « Adventure » products on our website.



 Compact composite panels

 Painted metal posts

 Painted metal posts

 Rotary moulded polyethylene

 Plywood

 Timber posts

ADVENTURE THEMED EQUIPMENT

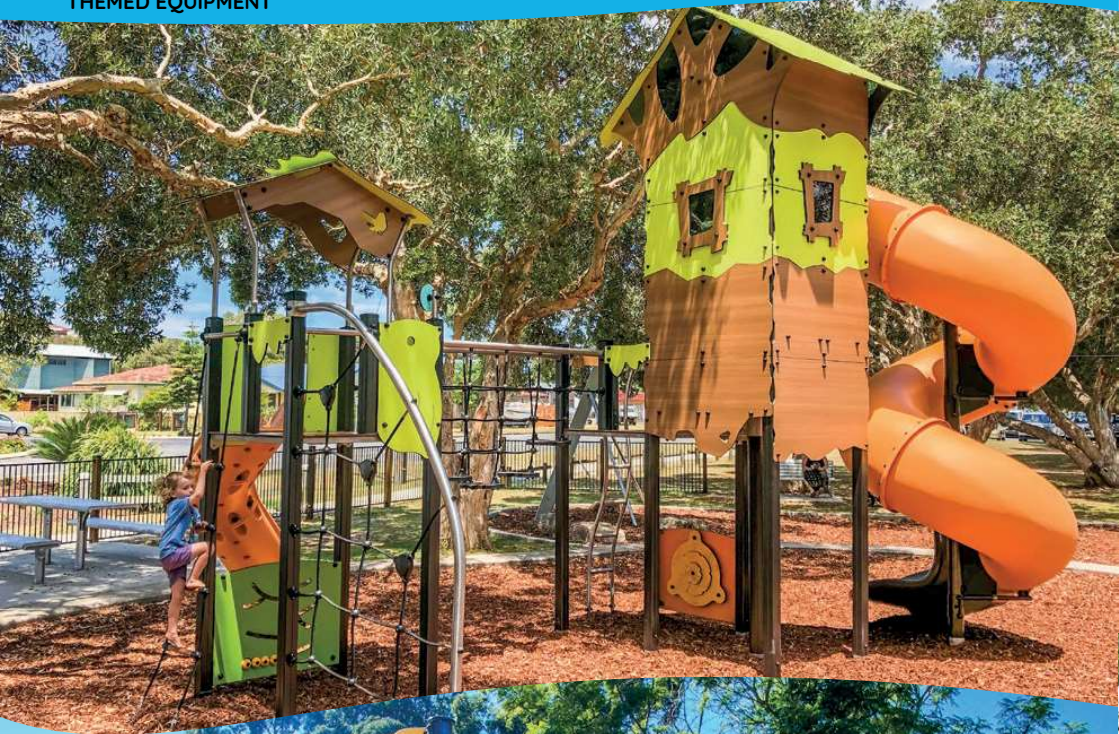







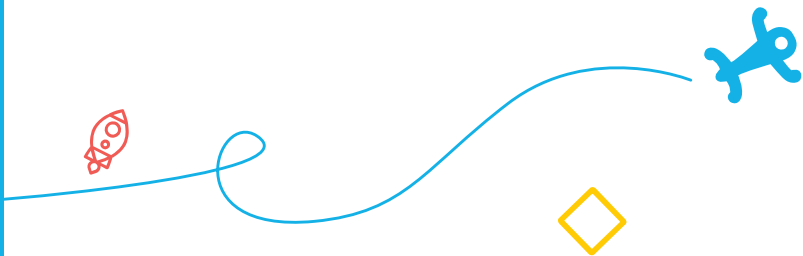



METROPOLIS
THEMED EQUIPMENT





The Metropolis range welcomes children to a world that draws its inspiration from the books of science fiction writers such as Jules Verne and H.G. Wells. The play structures are weird and wonderful machines, each complete with unique design details and imaginative play features.





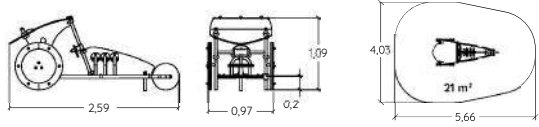

The combination of stainless steel posts and copper coloured play panels reinforce the futuristic look of the equipment.

J3601      

Dragster

J3601A	£5 659
J3601B	£5 659







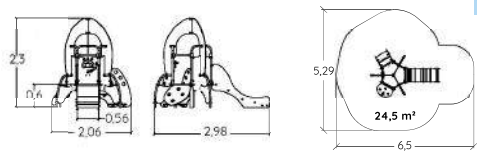

J3602      

Spoky

J3602A	£6 572
J3602B	£6 572







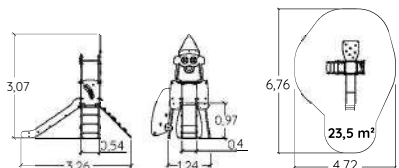

J4052      

Rocket

J4052A	£6 078
J4052B	£6 078



J4062      

Rocketship

J4062A	£10 195
J4062B	£10 195

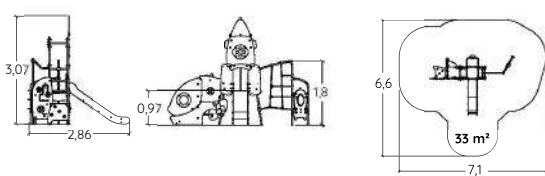

J4022



2 +

1 m

14

Inclusive Rocket

J4022A	£10 778
J4022B	£10 778

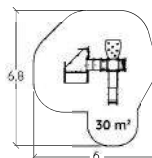
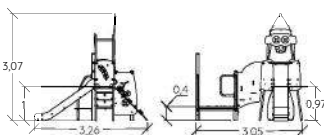

J4092



2 +

1,80 m

25

Rocket & Hot Air Balloon

J4092A	£20 431
J4092B	£20 431

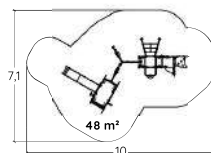
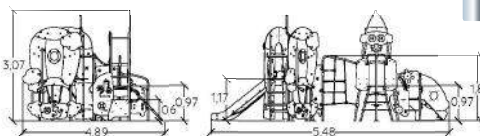

Compact composite panels

Stainless steel

Galvanised steel

Painted metal posts

J38301



2 +

1,17 m

15



J38301A

£11 764

J38301B

£11 764

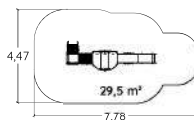
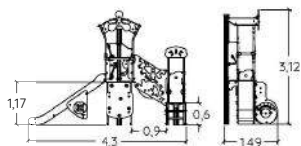

J38304



2 +

1,80 m

18



J38304A

£12 546

J38304B

£12 546

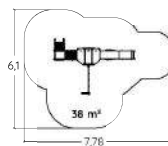
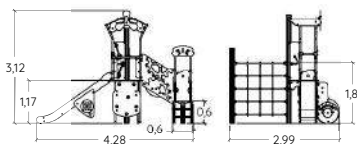

J38303



2 +

1,80 m

30



J38303A

£16 868

J38303B

£16 868

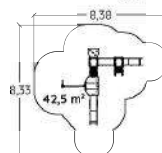
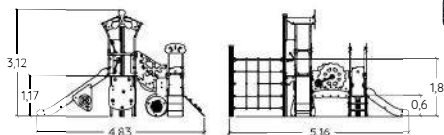

J38352

3 +

2,60 m

22

J38352A	£17 316
J38352B	£17 316

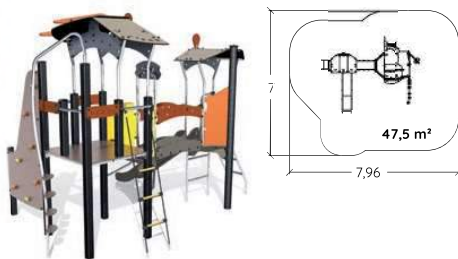
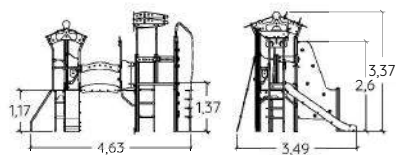

J47450



3 +

1,70 m

20

Nautilus

J47450A	£27 533
J47450B	£27 533

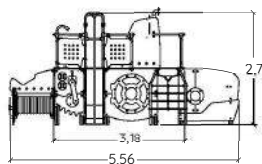
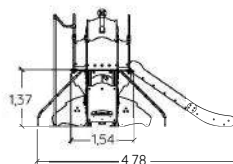
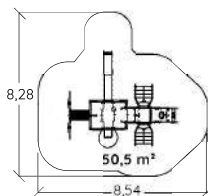

Compact composite panels

Stainless steel

Painted metal posts

METROPOLIS

THEMED EQUIPMENT



3 +





2,37 m



25

Octagonal tower

 J47101A-P	£64 932
 J47101A	£75 642

J47101-P

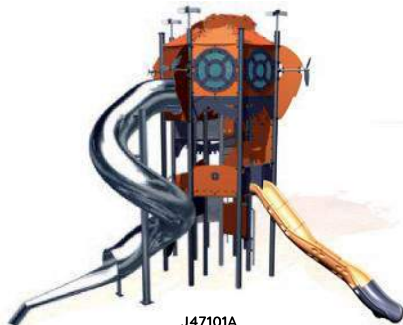
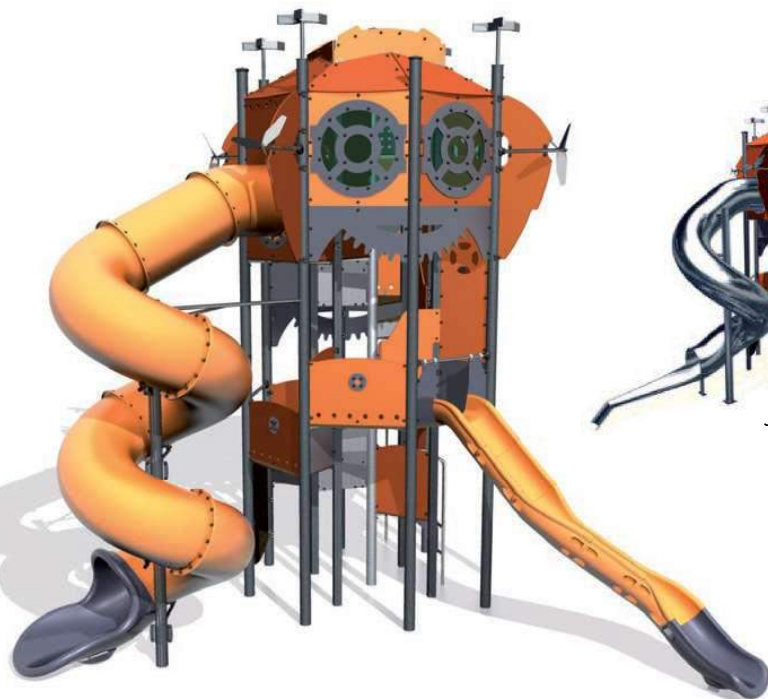

J47101A

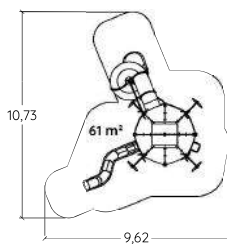
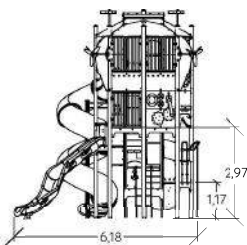
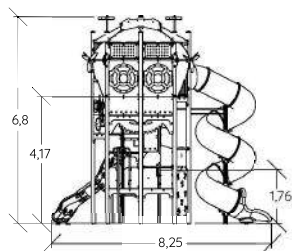

Find out more about the other 13 « Metropolis » products on our website.



 Compact composite panels

 Stainless steel

 Painted metal posts

Tubular slide
 Rotary moulded polyethylene

 Stainless steel





CITY
THEMED EQUIPMENT





The City theme takes children on a journey to an imaginary urban environment where they take on the role of a fireman, ambulance driver, postman, train driver, or even a passenger on an open-top bus.

The products are packed full of play features that are ideal sources of inspiration for role-playing games, as well as for the development of fine motor skills.

J4050



2+

1 m

10



Clock

J4050A	£4 935
J4050B	£4 935

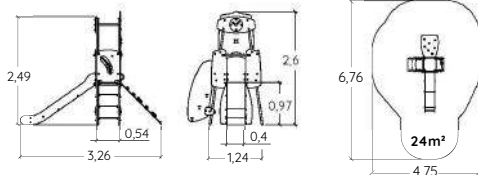

J4060



2+

1,80 m

16



The Town

J4060A	£9 644
J4060B	£9 644

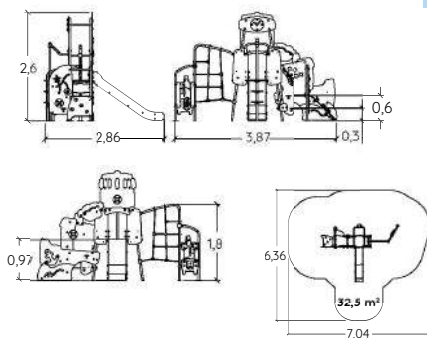

J4020



2+

1 m

14



Inclusive Clock

J4020A	£10 565
J4020B	£10 565

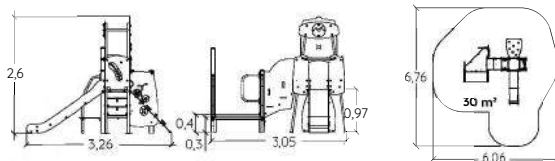

J38604



2+

1,80 m

18

J38604A

£12 012

J38604B

£12 012

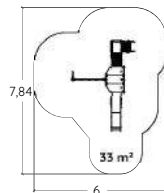
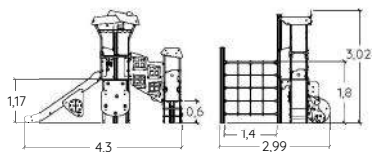

J38603



2+

1,80 m

30

J38603A

£16 243

J38603B

£16 243

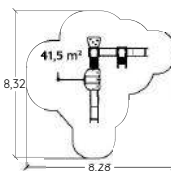
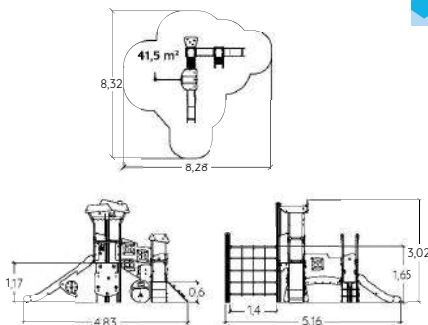

J4080



2+

1,80 m

25

City

J4080A

£19 667

J4080B

£19 667

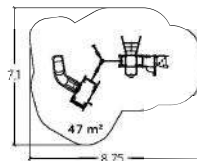
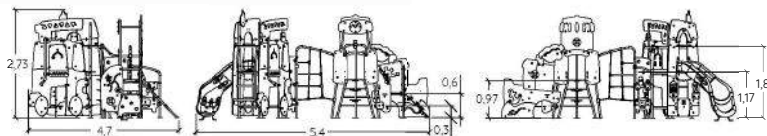

Compact composite panels

Stainless steel

Galvanised steel

Painted metal posts

J2612



2 - 6

0,46 m

6

Cuckoo

J2612A	£1 559
J2612B	£1 559

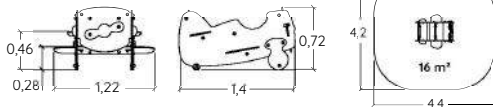

J2603



2 - 6

0,60 m

4

Aeroplane

J2603A	£3 341
J2603B	£3 341

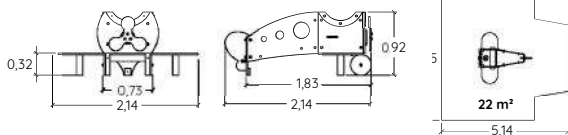

J2611®



2 - 6

0,50 m

3

Big Twiny

J2611A	£3 252
J2611B	£3 252

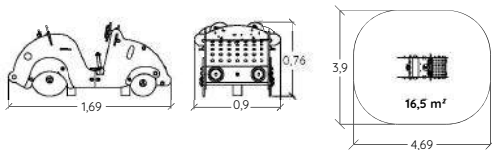

J2619



2 - 6

<0,60 m

6

Play Wagon

J2619A	£1 267
J2619B	£1 267

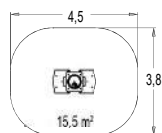
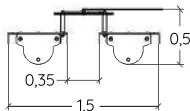
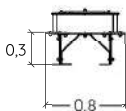

J2617



2 - 6

0,86 m

6

Engine

J2617A	£2 590
J2617B	£2 590

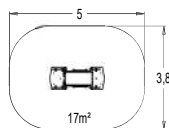
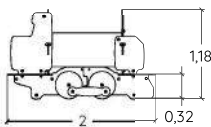
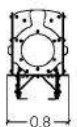
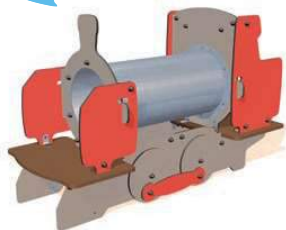

J2618



2 - 6

0,33 m

6

Shuttle

J2618A	£1 739
J2618B	£1 739

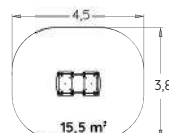
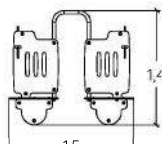
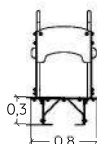

J2616



2 - 6

0,86 m

18

Choo Choo

J2616A	£5 452
J2616B	£5 452

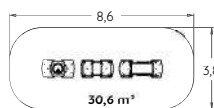
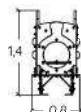
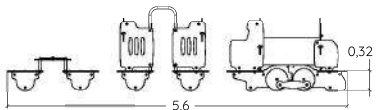

Compact composite panels

Plywood

Stainless steel

Galvanised steel

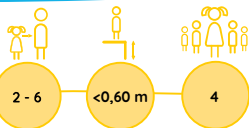

J2692

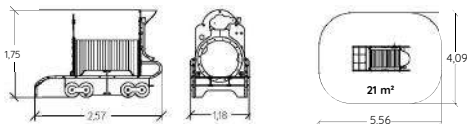

Locomotive

J2692A	£7 734
J2692B	£7 734

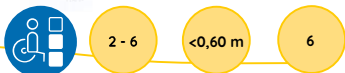

J2693

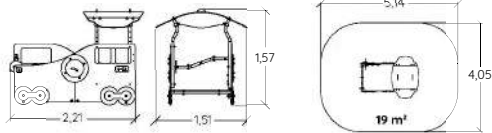

Covered Wagon

J2693A	£4 765
J2693B	£4 765

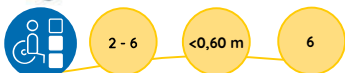

J2694

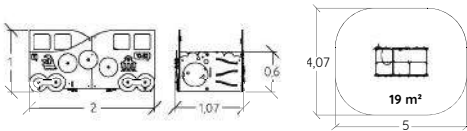

Labyrinth Wagon

J2694A	£5 581
J2694B	£5 581

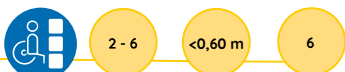

J2695

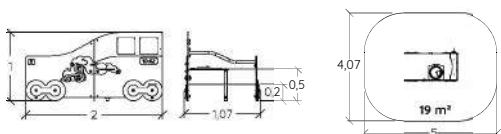

Play table Wagon

J2695A	£3 105
J2695B	£3 105



J2691



2 - 6

<0,60 m

22

Complete Train

J2691A

£21145

J2691B

£21145

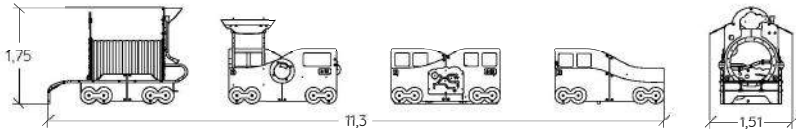
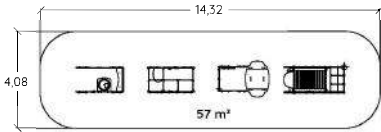

Compact composite panels

Stainless steel

J3512®

2+

0,50 m

5

Ludic Express

J3512A

£19 516

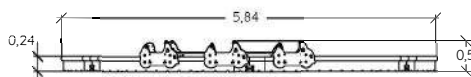
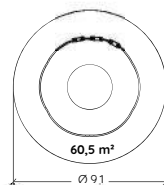
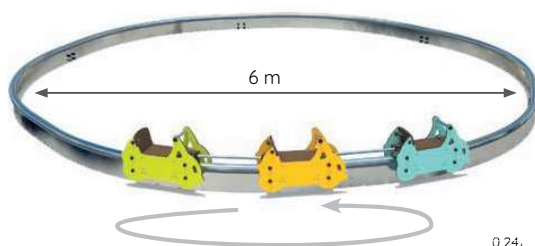

J2685



2 - 8

1,17 m

20

Double-Decker Bus

J2685A

£17 636

J2685B

£17 636

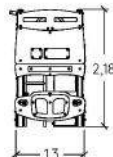
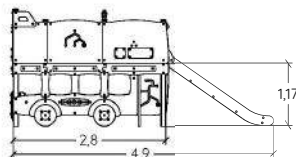
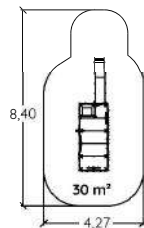

J2684



2

1,37 m

20

Recycling Truck

J2684A

£36 467

J2684B

£36 467

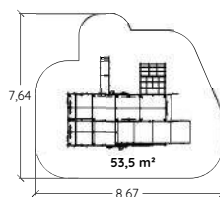
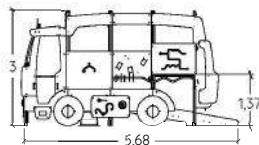
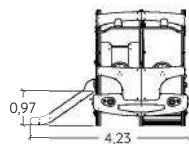

J4039



3 - 6

1 m

12

Jockey

J4039A

£13 256

J4039B

£13 256

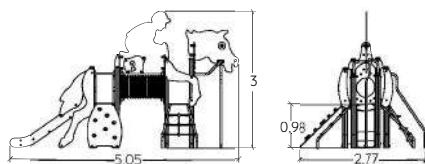
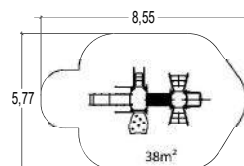
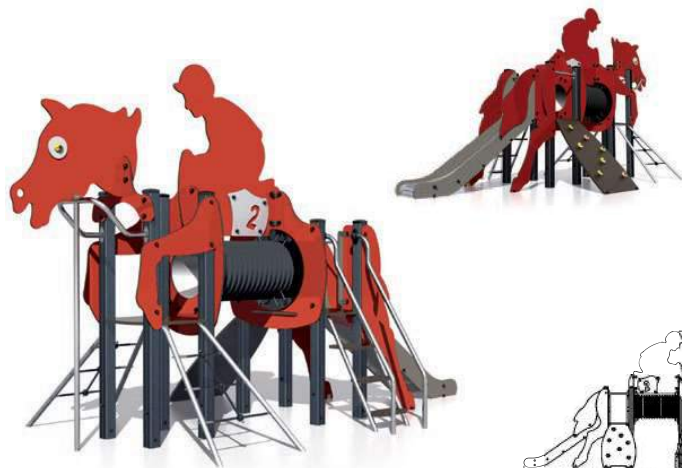

Find out more about the other 11 « City » products on our website.



Compact composite panels

Stainless steel

Painted metal posts



3 +



1,95 m



10

J2689®

Take-off Plane

J2689A	£20 520
J2689B	£20 520

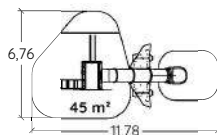
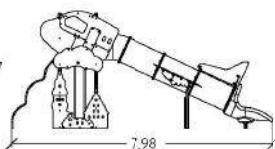
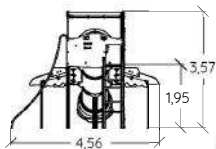
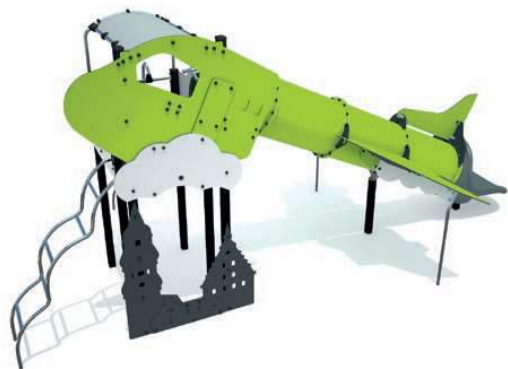

J2690



2 +

2 m

60

Giant Plane

J2690A

£107 427

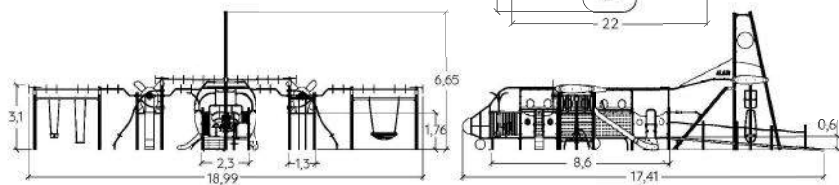
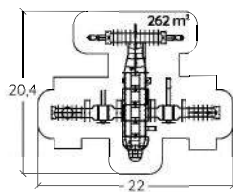

Compact composite panels

Stainless steel

Rotary moulded polyethylene

Painted Aluminum

Painted metal posts







AQUATICA
THEMED EQUIPMENT





To set sail across the stormy seas and be shipwrecked on a desert island. To drop anchor and go fishing with friends.

Children can create any number of adventures around our water-themed playgrounds. Each structure in the Aquatica range is equipped with numerous play elements designed to develop motor and fine motor skills, and stimulate the imagination.



J2604

2 - 6

0,60 m

6

Calypso

J2604A	£4 860
J2604B	£4 860

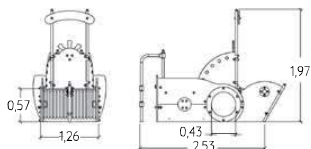
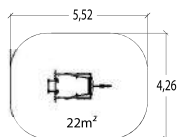

J2646-M



2 +

1,17 m

12

J2646A-M	£8 562
J2646B-M	£8 562

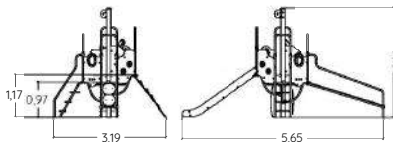
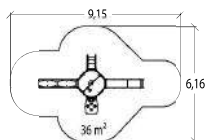

J1956

3 +

1,37 m

17



Trawler

J1956A

£15 097

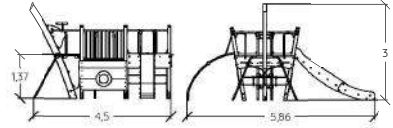
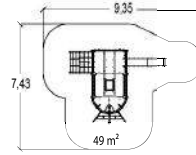

J1958



3 +

1,37 m

17



Shrimper

J1958A

£18 229

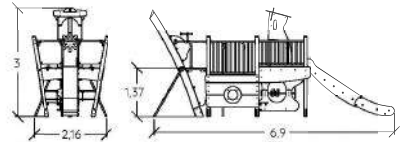
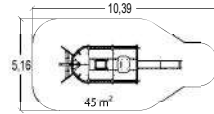

J1959



3 +

1,37 m

30



Tanker

J1959A

£26 350

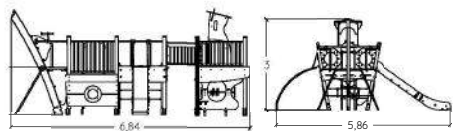
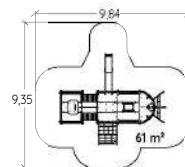

Compact composite panels

Stainless steel

Timber posts

Painted metal posts



J2751-M



4 +

1,37 m

15

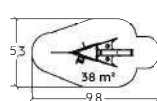
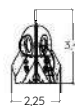
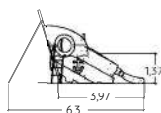
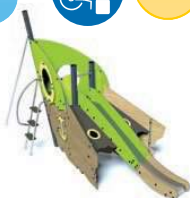

Keo Bow

J2751A-M

£12 124

J2755-M



4 +

1,37 m

30

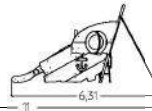
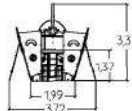
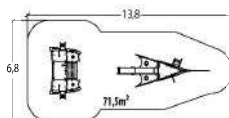

Keo Stern & Bow

J2755A-M

£22 765

J2750-M



4 +

2,20 m

40

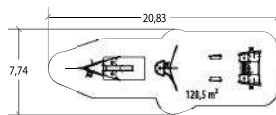
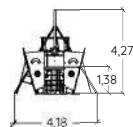
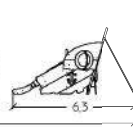
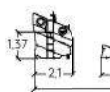

The Keo Shipwreck

J2750A-M

£27 909



J1962®



3 +

2,10 m

36

Neptune

J1962A

£41 673

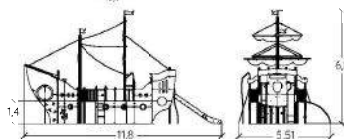
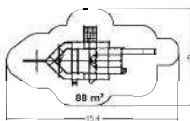

J47251®

3 +

2,37 m

18

Lighthouse

J47251A

£43 677

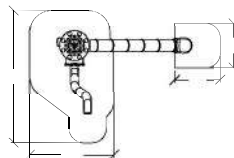
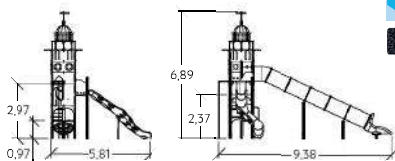

+ Find out more about the other 14 « Aquatica » products on our website.



 Compact composite panels

 Stainless steel

 Painted metal posts

 Rotary moulded polyethylene

 Timber posts



J1961



3 +

1,70 m

75

Unicorn

J1961A

£88 470

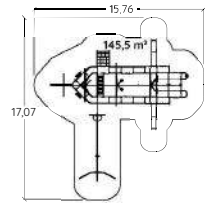
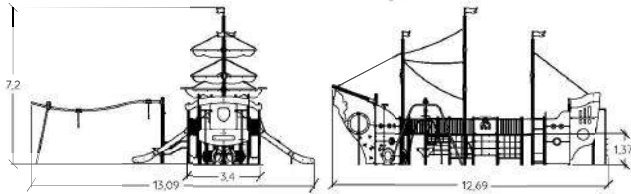

NEW

J2696®

2 +

2,20 m

70

The Whale

J2696A

£55 741

J2696B

£55 741

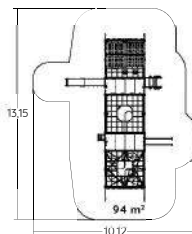
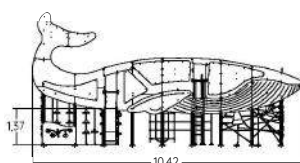
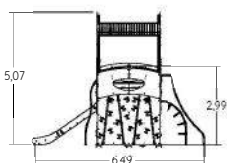
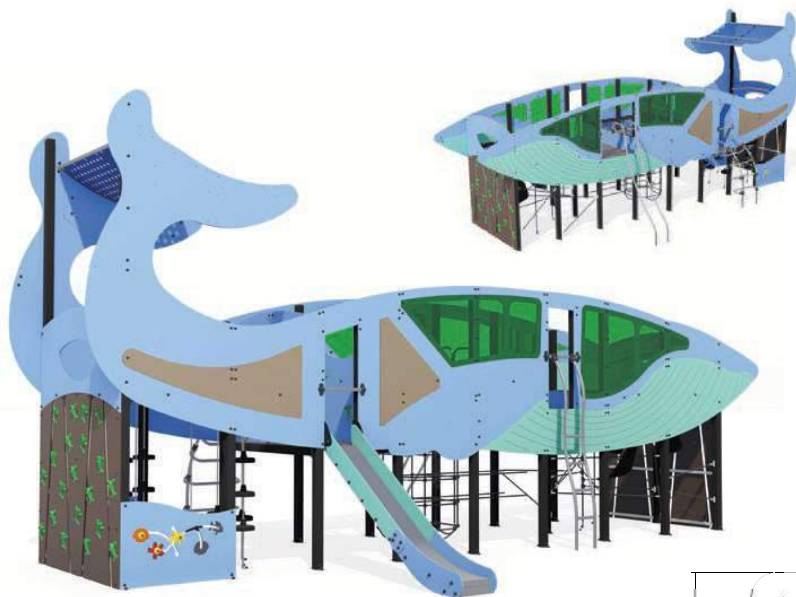

 Compact composite panels

 Stainless steel

 Painted metal posts



MEDIEVAL
THEMED EQUIPMENT





The Medieval theme transports children to a world of knights, castles and chivalry.

Symbols from this period such as turrets, shields and bridges adorn the play equipment. When combined with children's imagination the equipment becomes the starting point for a host of fun adventures. The numerous play panels add to the theme and test children's problem-solving skills.

J2605



2 - 6



0,60 m



6



Drawbridge

J2605A	£3 091
J2605B	£3 091

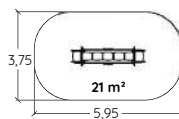
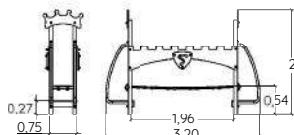

J38402



2 - 10

1 m

12



J38402A	£7 305
J38402B	£7 305

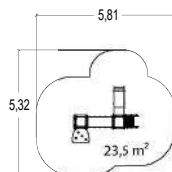
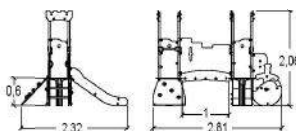

J2656-M



2 +

1,17 m

12



J2656A-M	£8 388
J2656B-M	£8 388

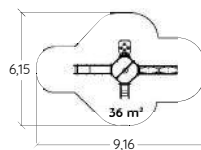
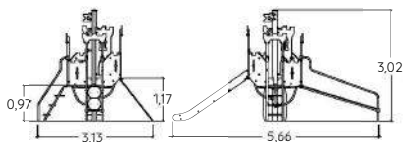

J38404



2 +

1,80 m

18



J38404A

£11 876

J38404B

£11 876

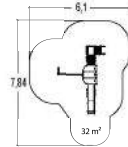
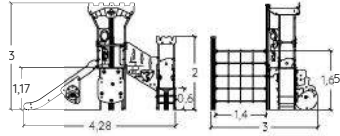

J38403



2 +

1,80 m

30



J38403A

£15 945

J38403B

£15 945

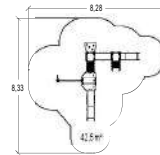
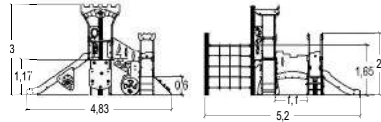

J38452

3 +

2,60 m

22



J38452A

£17 653

J38452B

£17 653

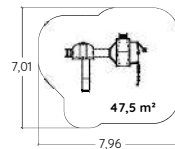
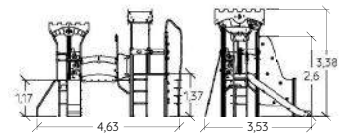

Compact composite panels

Plywood

Stainless steel

Painted metal posts

Timber posts

MEDIEVAL THEMED EQUIPMENT



3 +





2,37 m



25

Octagonal Tower

 J4701A	£69 182
 J4701A-P	£61 828



J4701-P



J4701A

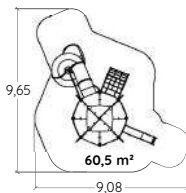
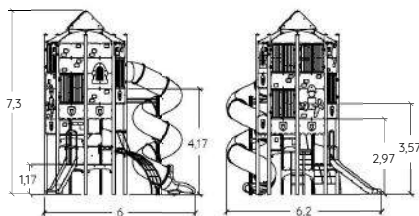

Find out more about the other 10 « Medieval » products on our website.



 Compact composite panels

 Stainless steel

 Painted metal posts

Tubular slide

 Rotary moulded polyethylene

 Stainless steel



**CRAFIC
GAMES**







ORIGIN' ROBINIA WOOD EQUIPMENT

Multiplay equipment	136
Themed equipment	144
Traditional equipment	150
Trail equipment	156



The Origin' range of play equipment recreates the very essence of what nature has to offer: a treehouse, crossing a stream over stepping stones or an uprooted tree trunk, an adventure trail that includes climbing, sliding and discovering, an encounter with animals or birds, a walk along a forest trail or venturing downriver.

Here, children play in a setting inspired by nature. Their senses are awakened and stimulated by the look and feel of the Robinia wood with its naturally irregular forms and enjoyable sensation beneath the fingers.

The play equipment in the Origin' range is designed for children aged one and above.



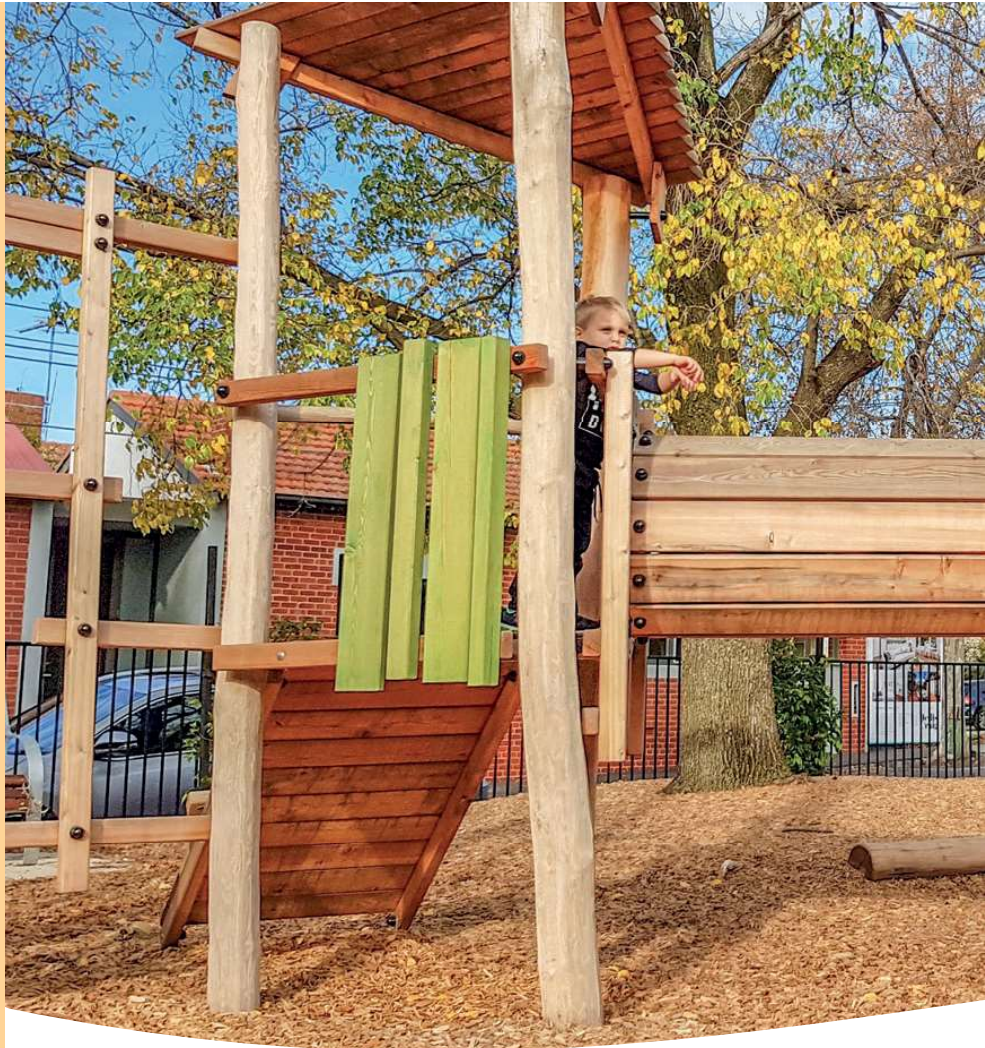

ORIGIN' MULTIPLAY EQUIPMENT
ROBINIA WOOD EQUIPMENT

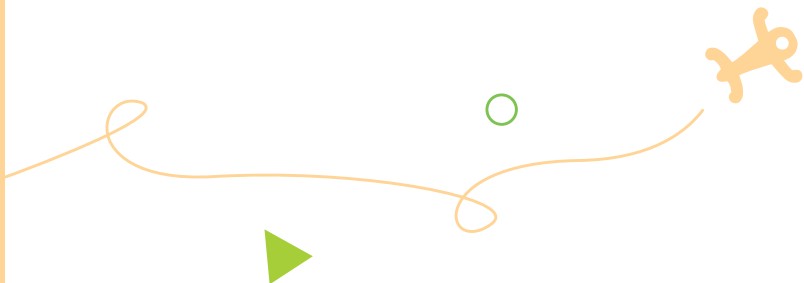

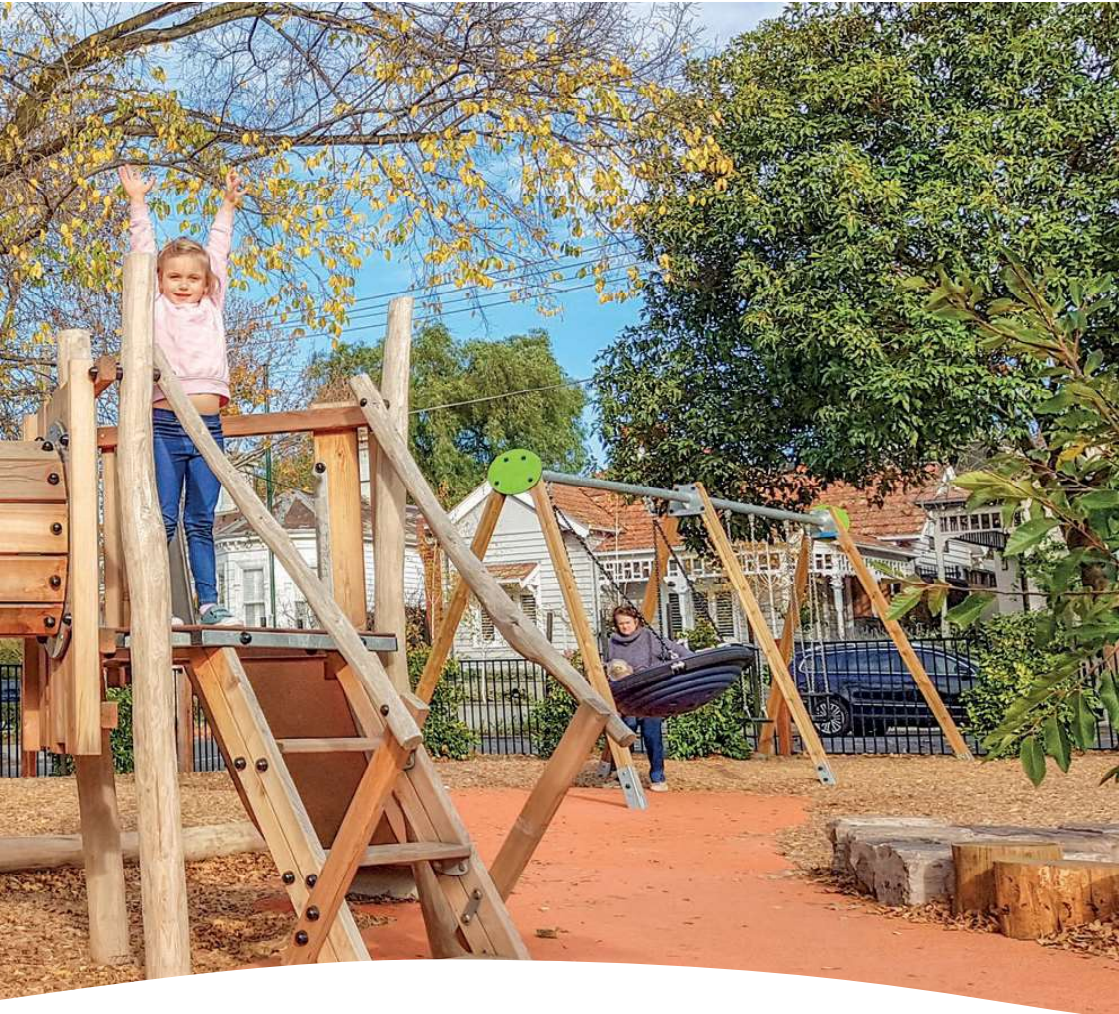

All children have the same dream of hiding away in a treehouse.

The multiplay structures in the Origin' range promise a number of original adventures in the heart of the natural countryside combining equipment with basic play features that will bring children together, including triangular towers with different platform heights, ladders, climbing ramps, fixed or moving bridges, tunnels, vertical nets, climbing walls, slides and sliding poles.

The highest combinations on offer stand over five metres tall and are adorned with unusual features, such as a stork's nest, the trees around the clearing and dilapidated cabins.

Splashes of colour truly bring out the originality of this range. The larch fence panels and playhouse walls are finished in shades of green to give an extra touch of natural harmony with the surrounding environment.



ORIGIN' MULTIPLAY EQUIPMENT

ROBINIA WOOD EQUIPMENT



J4940



1 - 8

<0,60 m

6

J4940A

£3 346

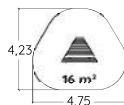
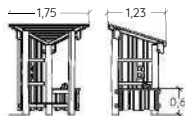

J4930-V



2+

1 m

8

J4930A-V

£6 477

J4930A

£6 477



J4930A-V



J4930A

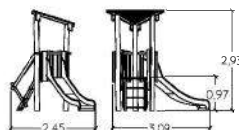
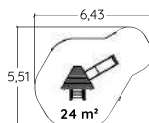

J4933-V



2+

1 m

12

J4933A-V

£11 424

J4933A

£11 424



J4933A-V



J4933A

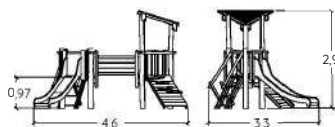
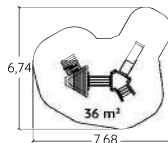

J4931

3 +

1,17 m

6



J4931A

£5 055

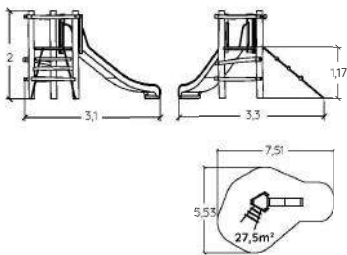

J4938

3 +

2,80 m

17



J4938A

£8 381

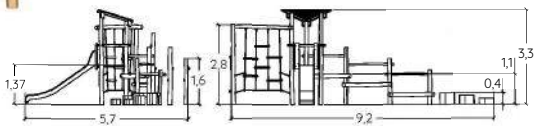
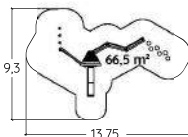

J4932-V

3 +

1,70 m

13

J4932A-V

£10 441

J4932A

£10 441



J4932A-V



J4932A

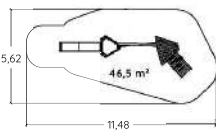

Robinia



Larch

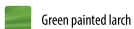

Green painted larch

ORIGIN' MULTIPLAY EQUIPMENT

ROBINIA WOOD EQUIPMENT



J4939

2 +

2,30 m

24

J4939A-V

£21 406

J4939A

£21 406



J4939A



J4939A-V

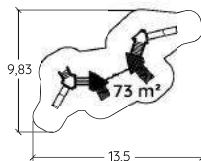
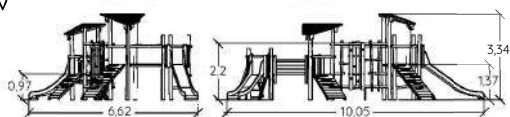

J4937-V

3 +

1,70 m

17

J4937A-V

£10 932

J4937A

£10 932



J4937A-V

J4937A

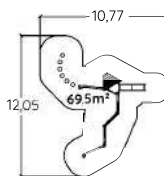
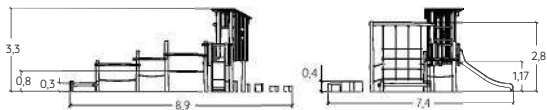

J4934

3 +

2,30 m

32

J4934A

£15 260

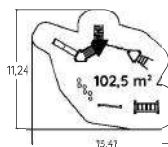
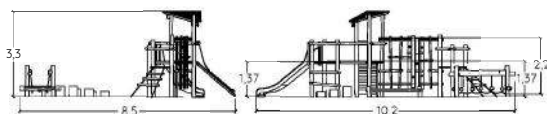

J4947-V



3 +

1,70 m

34

J4947A-V

£20 822

J4947A

£20 822



J4947A-V

J4947A

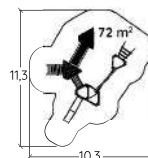
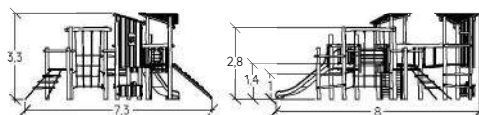

Robinia

Larch

Green painted larch

ORIGIN' MULTIPLAY EQUIPMENT

ROBINIA WOOD EQUIPMENT

NEW

J49411®



2 +

1,77 m

26



The Nest Tower

J49411A

£31 958

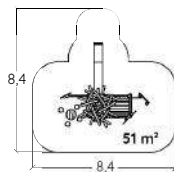
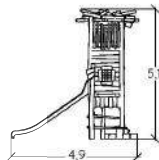
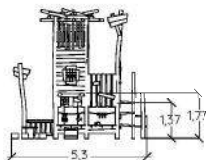

NEW

J49417®

3 +

1,17 m

36

The Observatory Tower

J49417A

£99 748

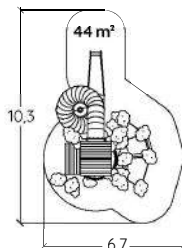
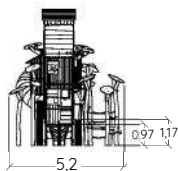
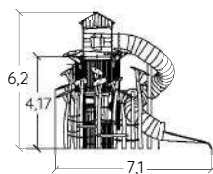

 Robinia

 Compact composite panels

 Tubular slide: Stainless steel

 Stainless steel



ORIGIN' THEMED EQUIPMENT
ROBINIA WOOD EQUIPMENT





Children love escaping to an imaginary world where anything can happen. Whether on land, at sea or in the air, they pretend to be explorers, seafarers, merchants or aviators. They produce and act out fantasy stories with plenty of twists and turns that epitomise their creativity.

The structures with their imaginative shapes offer a wealth of details for enhancing the play experience.

Some provide traditional and must-have activities, while others contain countless accessories or play with perspective, such as optical illusions.



ORIGIN' THEMED EQUIPMENT

ROBINIA WOOD EQUIPMENT



NEW

J4949®



2+

0 m

1

Squirrel
J4949®



Owl
J4952®



Seagull
J4955®



High anamorphosis

J4949A	£2 671
J4952A	£2 671
J4955A	£2 671

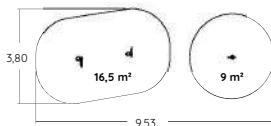

NEW

J4950®



2+

0 m

1

Dolphin
J4950®



Wild Boar
J4951®



Fox
J4958®



Low anamorphosis

J4950A	£2 779
J4951A	£2 779
J4958A	£2 779

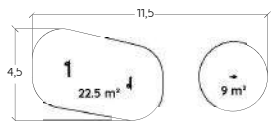

NEW

J49146®

1+

<0,60

1

The Tree

J49146A

£881

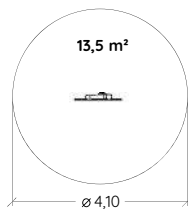

J3426®



1+

<0,60 m

1

Pixel Panel

J3426A

£1 673

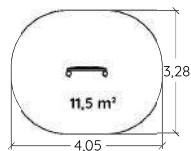
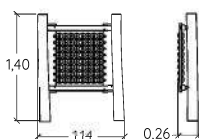

J49100®



1+

<0,60 m

8

Little House

J49100A

£4 889

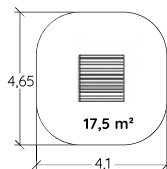
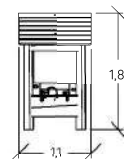
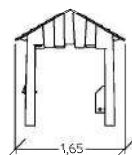

ORIGIN' THEMED EQUIPMENT

ROBINIA WOOD EQUIPMENT



J49107®



1+

<0,60 m

6

The Shop

J49107A

£4 566

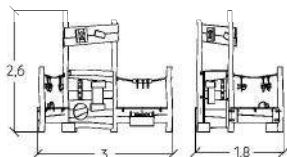

J49101®



1+

<0,60 m

8

Sloop

J49101A

£5 621

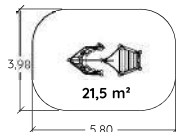
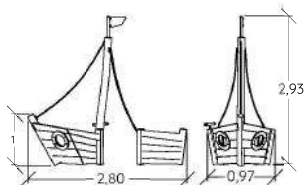

J49102®



2+

0,75 m

6

The Jeep

J49102A

£5 908

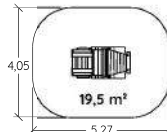
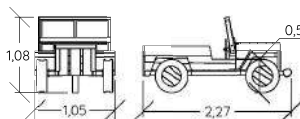

J49104®

2+

1 m

6

The Bear

J49104A

£6 233

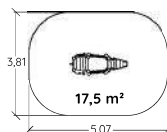
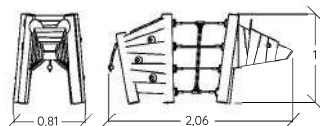

J49103®

2+

1m

6

Biplane

J49103A

£5 982

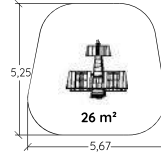
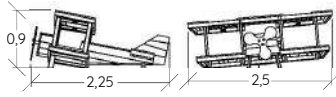

NEW

J49145-V®



2+

1m

8

The inclusive lodge

J49145A-V

£11 276

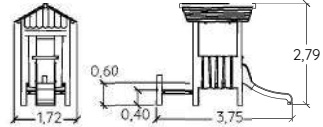
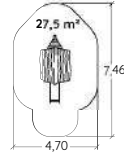

NEW

J49302®



2+

1,17 m

25

The Frigate

J49302A

£24 515

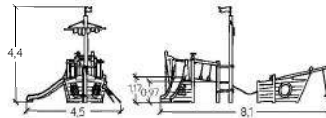
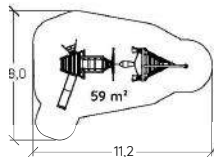



ORIGIN' TRADITIONAL EQUIPMENT
ROBINIA WOOD EQUIPMENT

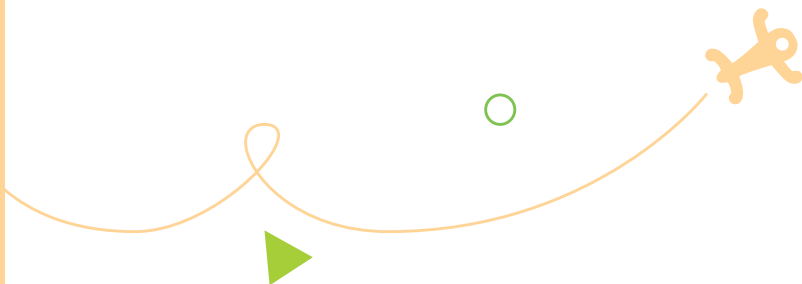



Swings, springers and roundabouts are firm favourites among children of all ages. They can be installed near each other or added to a play space built around a multiplay structure.

Comprising Robinia wood boards, posts and beams, Origin' structures embrace the shape of the wood, which gives the playground a highly intensified natural look.



ORIGIN' TRADITIONAL EQUIPMENT

ROBINIA WOOD EQUIPMENT



J498

1+

1,50 m

2

J498A

£2 718

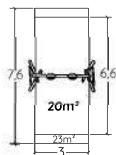

J489®



1+

1,50 m

2

J489A

£2 601

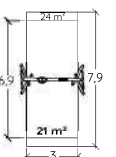
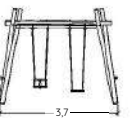

J490



2+

1,40 m

2

J490A

£1 710

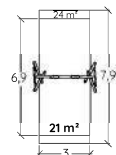
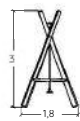

J491



2+

1,55 m

5

J491A

£3 213

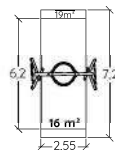
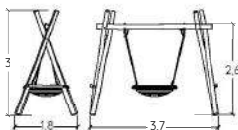

J499

2+

1,50 m

4

J499A

£5 804

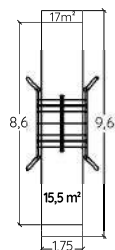
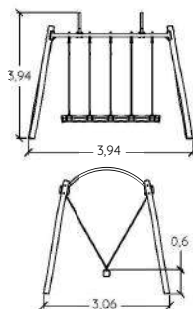

ORIGIN' TRADITIONAL EQUIPMENT

ROBINIA WOOD EQUIPMENT



J880

2+

0,60 m

1

J880A

£743

J880B

£743

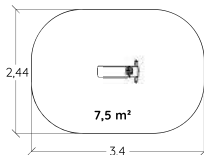
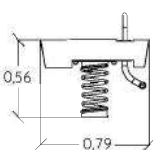
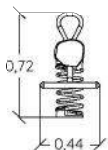

J881

2+

0,60 m

1

J881A

£758

J881B

£758

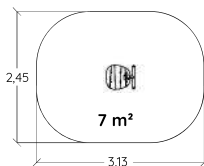
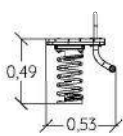
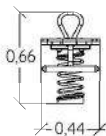

J882®

2+

0,60 m

2

J882A

£896

J882B

£896

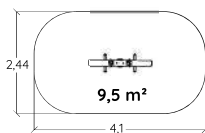
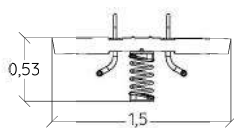

J4920

3+

1,17 m

2

Seesaw

J4920A

£1 356

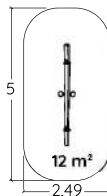
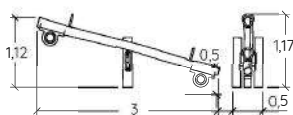

J49142®



3+

1m

6

Origin' Roundabout

J49142A

£2 273

J49142B

£2 273

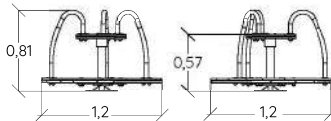
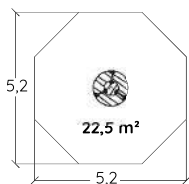

J49105®



3+

0,60 m

5

Lily Pad

J49105A

£2 530

J49105B

£2 530

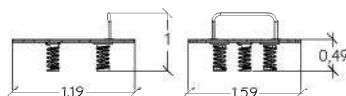
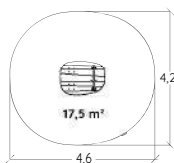

Robinia



Stainless steel



ORIGIN' TRAIL EQUIPMENT
ROBINIA WOOD EQUIPMENT

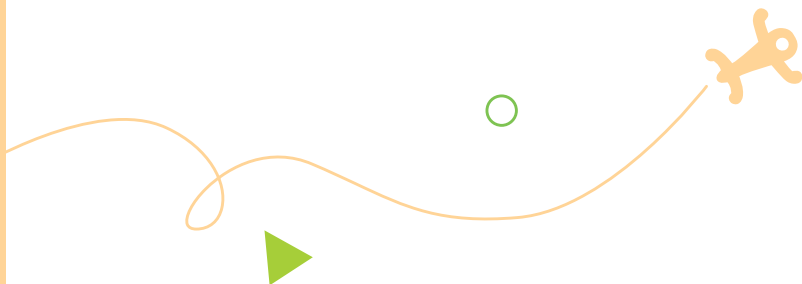



The Origin' trail equipment offers different levels of difficulty. The most accessible items include stepping stones, beams and low gangways, which help children to work on their sense of balance and overcome their fear of heights.

The equipment gradually becomes narrower, higher and more challenging. Children can gain a foothold on the rounded beams, moving gangways and flexible ropes. Various techniques are used to cross the different items of play equipment. Those techniques gradually scale in complexity with the aim of helping children coordinate their movements and control their body in suspended space.

Finally, they can improve their technique, strength and self-control on the climbing equipment or structures where they need to use their arm strength to get from one side to the next.



ORIGIN' TRAIL EQUIPMENT

ROBINIA WOOD EQUIPMENT



J4903

3 +

<0,60 m

3

Balance Beam

J4903A

£330

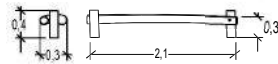
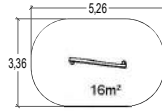

J4906

3 +

<0,60 m

4

Gateway

J4906A

£957

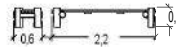
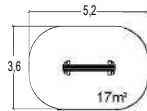

J4907

3 +

<0,60 m

6

Log Trail

J4907A

£1 007

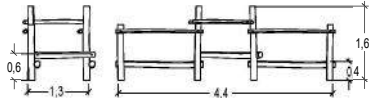
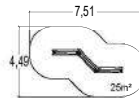

J4904

3 +

<0,60 m

3

Japanese Steps

J4904A

£1 192

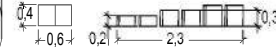
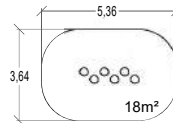

J4908

3 +

<0,60 m

6

Suspended Trail

J4908A

£1 277

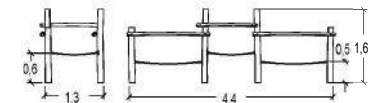
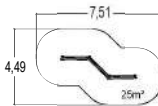
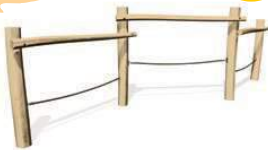

J4901

3 +

<0,60 m

4

Log Walkway

J4901A

£1 732

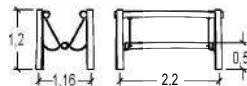
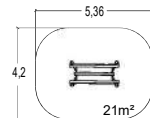

J4913

3 +

1,70 m

4

Vertical Net

J4913A

£1 560

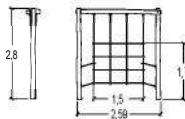
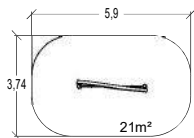

J4902

3 +

<0,60 m

5

Net Walkway

J4902A

£2 259

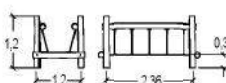
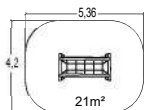

J4900

3 +

<0,60 m

5

Swinging Log Walkway

J4900A

£2 544

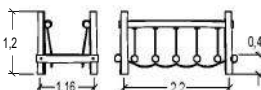
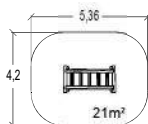

J4905

4 +

2,10 m

3

Climbing Logs

J4905A

£594

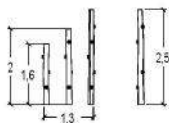
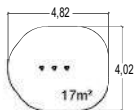



J4910

6+

1,90 m

3

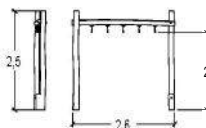
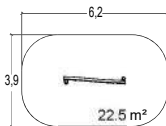

Suspended Rings

J4910A

£987

J4909

6+

2,20 m

4

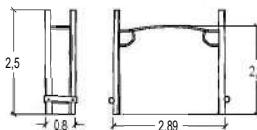
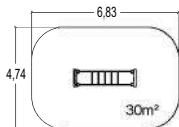

Monkey Bars

J4909A

£1 884

J4911

6+

1 m

3

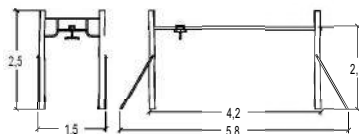
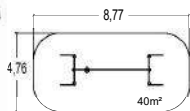

Aerogliss

J4911A

£5 134

J4912

10+

1,70 m

3

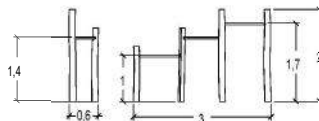
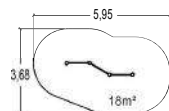

Horizontal Bars

J4912A

£1 026

J4945

3 +

0,60 m

26

J4945A

£5 645

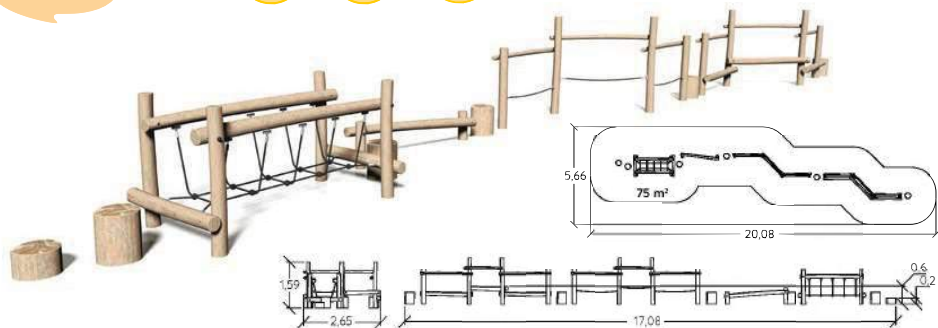

J4946

6 +

1,70 m

17

J4946A

£5 124



Robinia

Stainless steel

ORIGIN' TRAIL EQUIPMENT

ROBINIA WOOD EQUIPMENT

NEW

J49156

2+

0,60 m

5

The Log Stack

J49156A

£1 327

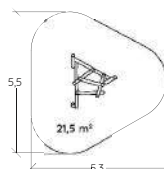
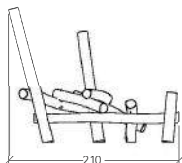
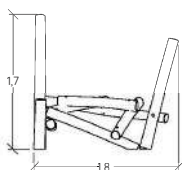

NEW

J49157

2+

0,60 m

7

The Log Stack XL

J49157A

£1 710

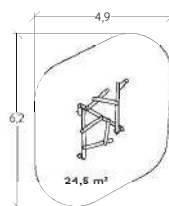
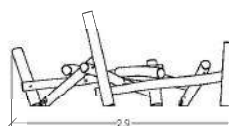
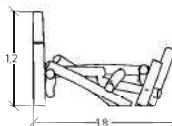

NEW

J49160

2+

0,60 m

17

The Parkour Log Stack

J49160A

£9 031

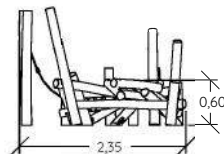
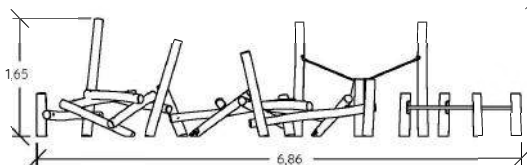
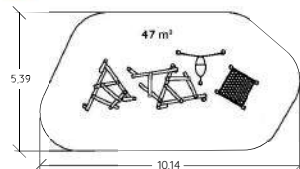

NEW

J49143®

3+

0,7 m

6

The Parkour in the trees

J49143A

£2 893

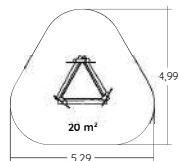
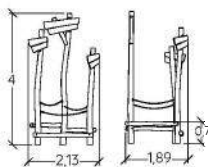

NEW

J49144®



2+

<0,60

4

The Net

J49144A

£3 160

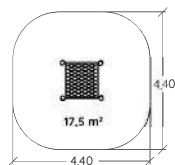
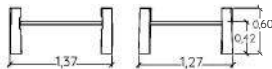

J4914®



3+

<0,60 m

1

Hammock

J4914A

£1 801

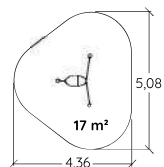
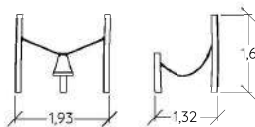

NEW

J49125®

3+

0,97 m

21

The Suspended Walkway

J49125A

£16 517

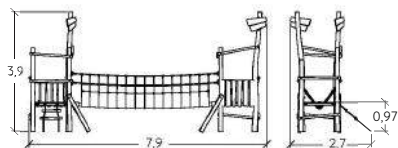
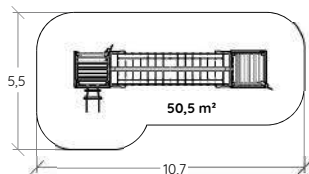

ORIGIN' ROBINIA WOOD EQUIPMENT









MOVING EQUIPMENT

- Springers 168
- Rotating equipment 182
- Cableways 190

Popular with younger and older children alike, moving play equipment provides a key focus of activity, offering a wide variety of sensations: swinging and balancing, rocking and gliding, moving through space, fast and slow.

Children will love the dynamic experience of our cableways, spring motion and rotating equipment.





SPRINGERS
MOVING EQUIPMENT

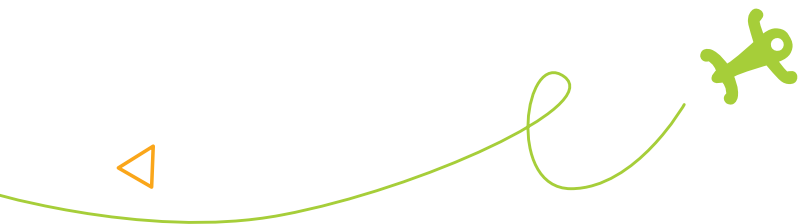



Springers are an essential element of any play space for young children. They enhance a toddler's sense of balance and help them coordinate their movements, while giving older children great fun as they swing away wildly.

Springers are equipped with suitably-sized footrests and handles, so they're ergonomically designed for maximum user comfort and safety. Their playful and colourful shapes are based on familiar themes, designed to stimulate a child's imagination.



J3961®



0,5 - 5

0,60 m

1

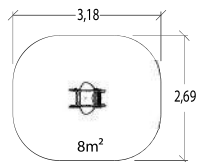
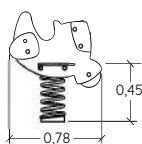
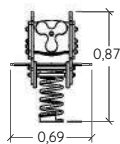

Looping

J3961A £1 534

J3961B £1 534

J866



1 - 5

0,60 m

1

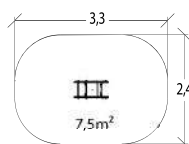
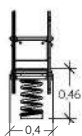

Snail

J866A £1 259

J866B £1 259

J834®



1 - 5

0,60 m

1

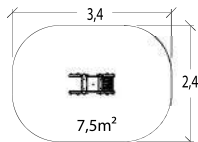
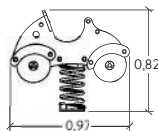
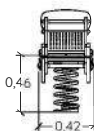

Tring

J834A £1 352

J834B £1 354

J837



2 - 8

0,60 m

1

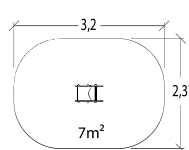
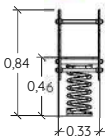

Duck

J837A £706

J837B £721

J856



2 - 8

0,60 m

1

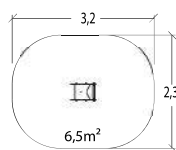
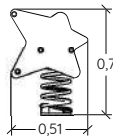
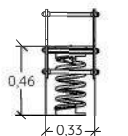

Stella The Star

J856A £680

J856B £704



J867



2 - 8

0,60 m

1

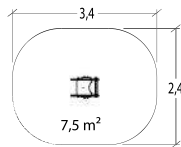
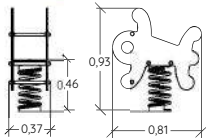

Frog

J867A £1 004

J867B £1 004



J864



2 - 8

0,60 m

1

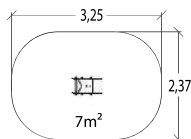
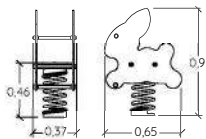

Bunny

J864A £991

J864B £991



J869®



2 - 8

0,60 m

1

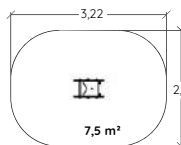
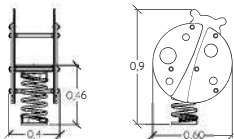

Ladybug

J869A £1 311

J869B £1 311



J833

2 - 8

0,60 m

1

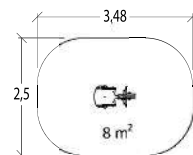
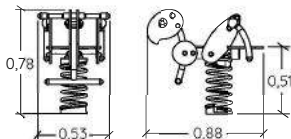

Gemini

J833A £1 311

J833B £1 335



J836



2 - 8

0,60 m

1

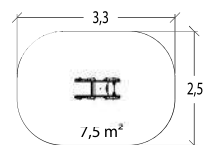
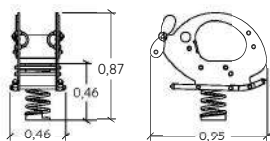

Hornet Helicopter

J836A £1 531

J836B £1 534



Compact composite panels

Stainless steel

SPRINGERS

MOVING EQUIPMENT

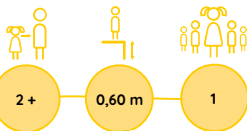

J854

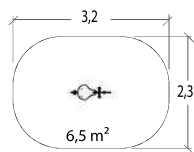
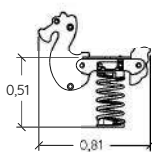

Seahorse

J854A	£562
J854B	£605

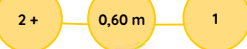

J855

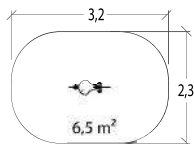
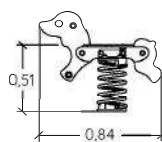
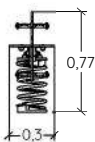

Doggy

J855A	£562
J855B	£605

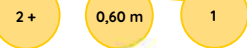

J857

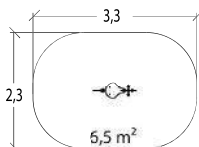
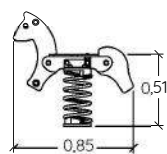

Jumpy the Horse Springer

J857A	£562
J857B	£605

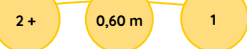

J880

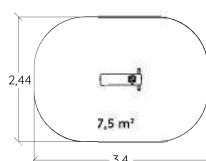
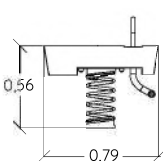
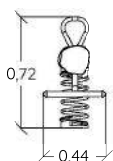

J880A	£743
J880B	£743



J881

2+

0,60 m

1

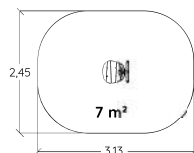
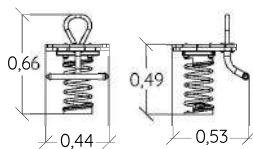

J881A	£758
J881B	£758

J828

2+

0,60 m

1

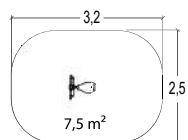
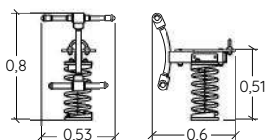
*Cyclo Springer*

J828A	£834
J828B	£862

J870®

2+

0,60 m

1

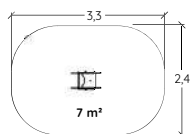
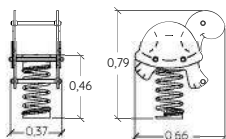
*Tortoise*

J870A	£1 022
J870B	£1 022

J818

2+

0,60 m

1

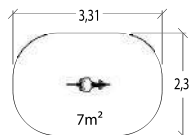
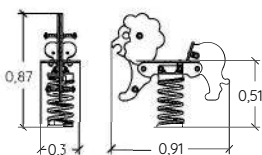
*Leo*

J818A	£922
J818B	£933

J802

2+

0,60 m

1

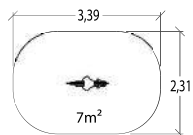
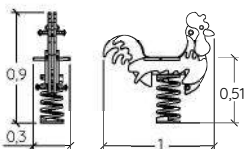
*Rooster*

J802A	£1 207
J802B	£1 223

Compact composite panels

Stainless steel

Robinia



J819



2+

0,60 m

1

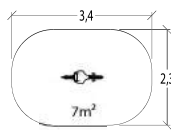
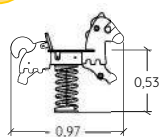
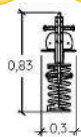

Horse

J819A £1 024

J819B £1 035



J820



2+

0,60 m

1

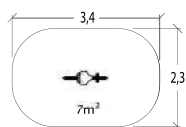
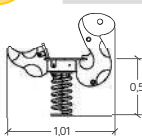

Snake

J820A £1 030

J820B £1 061



J821



2+

0,60 m

1

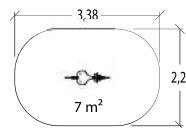
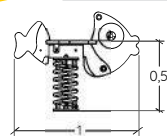

Fish

J821A £1 030

J821B £1 061



J835®



2+

0,60 m

1

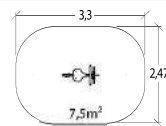
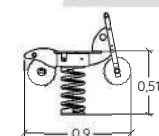
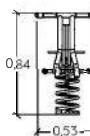

Biky

J835A £1 264

J835B £1 290



J838



2+

0,60 m

2

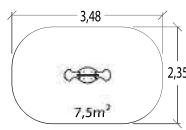
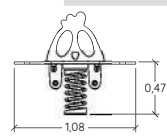

Chicken

J838A £732

J838B £745



J882®



2+

0,60 m

2

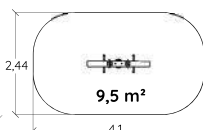
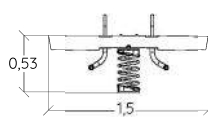

J882A £896

J882B £896



J844

2 +

0,60 m

2

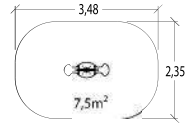
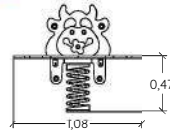
*Margerite The Cow***J844A****£1 145****J844B****£1 175****J842**

2 +

0,60 m

2

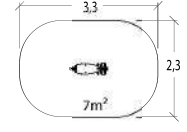
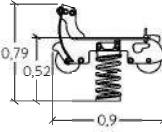
*La Dolce Vita***J842A****£1 175****J842B****£1 205****J827**

2 +

0,70 m

2

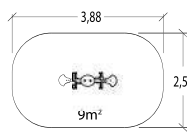
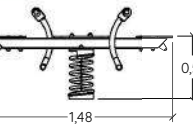
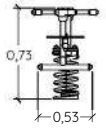
*Duo***J827A****£1 356****J827B****£1 380****J822**

2 - 10

0,60 m

2

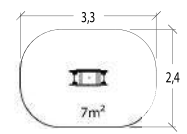
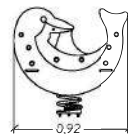
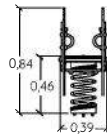
*Little Dolphin***J822A****£1 421****J822B****£1 458****J858**

2 +

0,60 m

2

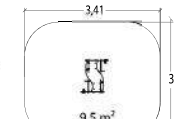
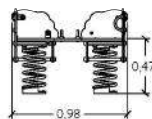
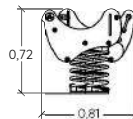
*Face to Face***J858A****£1 624****J858B****£1 594****J986**

4 +

1 m

2

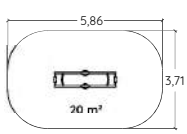
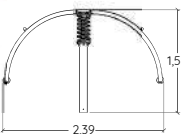
*Double Perch***J986A****£3 255**

Compact composite panels

Stainless steel

Galvanised steel

Robinia

Painted metal posts



J839

2+

0,60 m

4



Falling Star

J839A	£767
J839B	£791

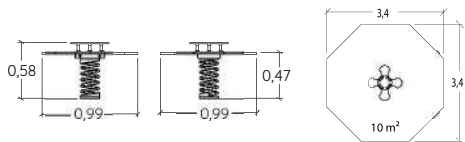

J846

2+

0,60 m

3



Chickies

J846A	£966
J846B	£1 000

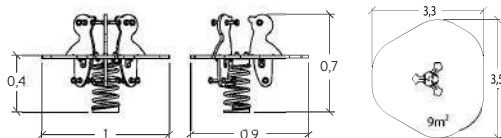

J853

2+

0,75 m

4



Cluby

J853A	£1 529
J853B	£1 484

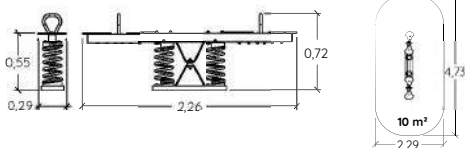

J826

2+

0,60 m

4



Ducklings

J826A	£2 141
J826B	£2 162

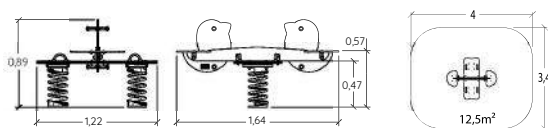

J985

2+

0,75 m

4



Tree Frogs

J985A	£2 162
J985B	£2 123

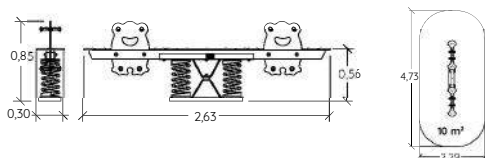

J830

2+

0,70 m

6

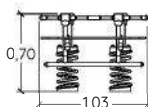
*Quatro***J830A****£2 344****J830B****£2 439***Dolphin***J981A****£3 366****J981B****£3 192****J981**

2+

0,60 m

6

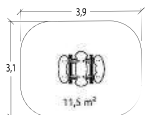
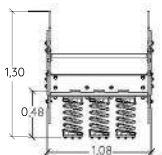
**J859**

2+

0,60 m

6

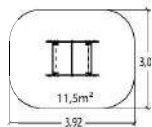
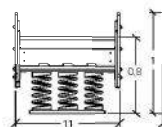
*Rowing Boat***J859A****£3 491****J859B****£3 491****J984**

2+

0,60 m

8

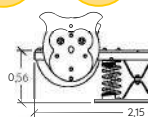
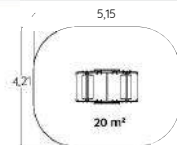
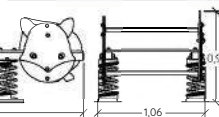
*Forest***J984A****£5 144****J984B****£4 784****J951®**

2+

0,60 m

10

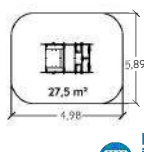
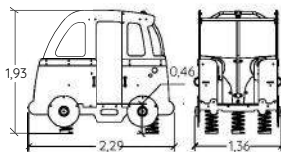
*Van***J951A****£8 575****J951B****£8 575**

Find out more about the other 20 « Springers » products on our website.



Compact composite panels

Stainless steel

Galvanised steel

SPRINGERS

MOVING EQUIPMENT

J952®



2+

0,60 m

8



Inclusive All-Terrain Vehicle

J952B

£10 815



Play panels

Steering wheel & audio play panel



Dynamic play structure mounted on 3 springs

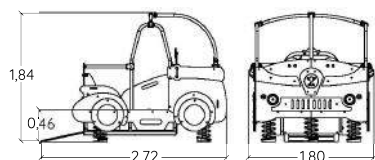
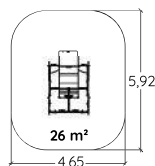

Sliding access ramp with retention system



J987®



3 +

0,60 m

6

Inclusive Wheelchair Seesaw

J987B

£9 874



Platform for standing children

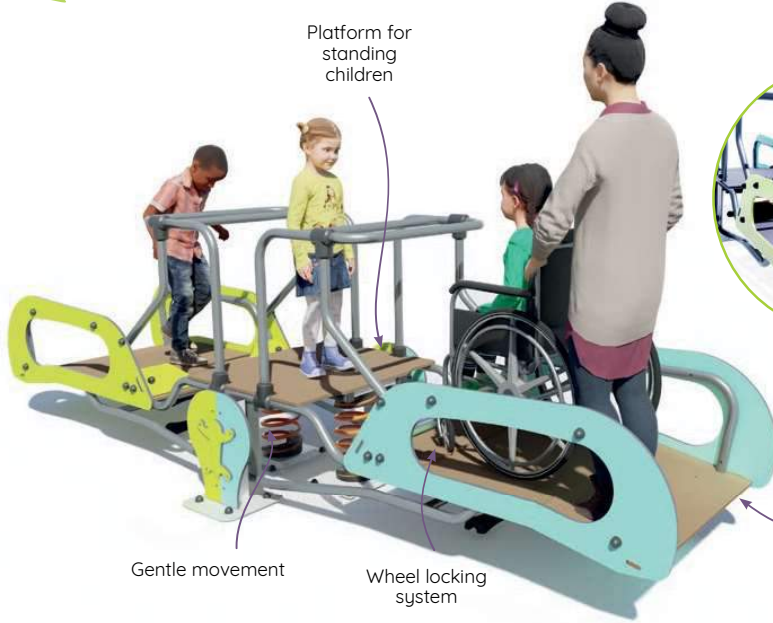

Gentle movement

Wheel locking system

Specific wheelchair access

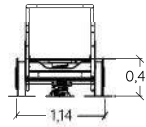
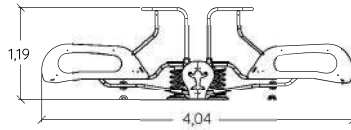
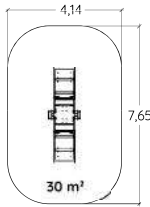

Compact composite panels

Stainless steel

SPRINGERS

MOVING EQUIPMENT







ROTATING EQUIPMENT

MOVING EQUIPMENT





Children of all ages love rotating equipment.

Younger children gradually learn to enjoy the exhilaration of speed on roundabouts. As children get older and more self-assured, they can test their balance and push their limits on more challenging dynamic structures that combine rotation and swinging.

ROTATING EQUIPMENT

MOVING EQUIPMENT



J2411®



1+

1m

1

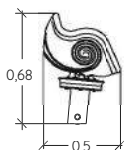

Rotofun

J2411A

£1 776

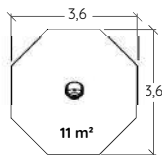

J2403



2+

1m

5

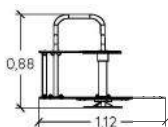

Inclusive Whirlwind

J2403A

£2 372

J2403B

£2 169

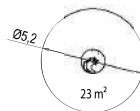
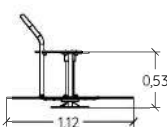

J2404



2+

1m

4

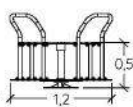
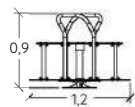

Double Inclusive Whirlwind

J2404A

£2 717

J2404B

£2 514

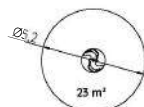

J2400



3+

1m

8

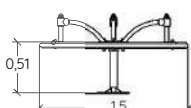

Speed Gyro

J2400A

£3 592

J2400B

£3 311

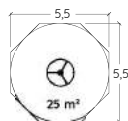

J3510®

6 +

0,70 m

3



Rollrunner

J3510B

£13 095

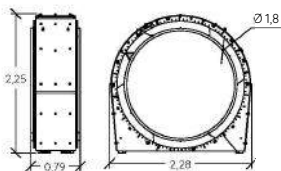
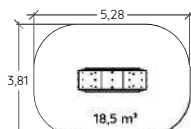

J3511®

6 +

0,70 m

3

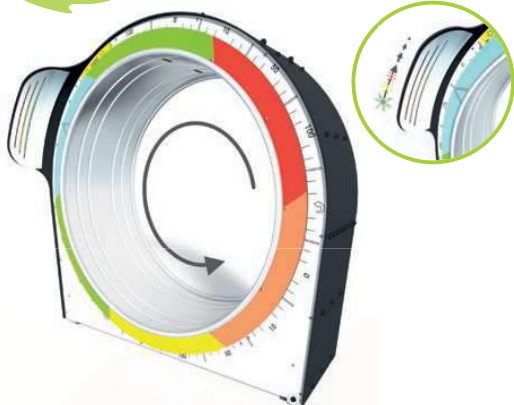

E-Rollrunner

J3511B

£18 733

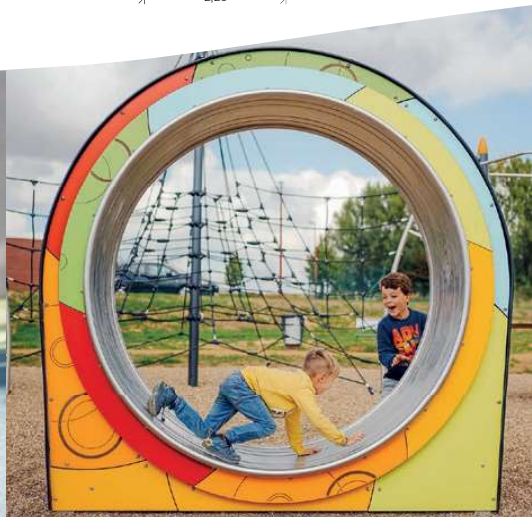
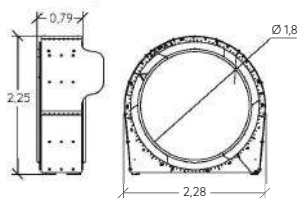
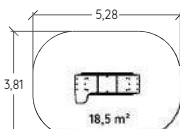

Compact composite panels

Stainless steel

Galvanised steel

Rotary moulded polyethylene

Polyethylene

ROTATING EQUIPMENT

MOVING EQUIPMENT

J2409



2+

1 m

6



Inclusive Roundabout

J2409A	£5 916
--------	--------

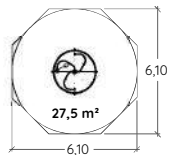
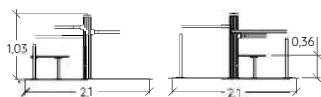

J2401



3+

1 m

6



Tournicolo

J2401A	£2 899
J2401B	£2 670

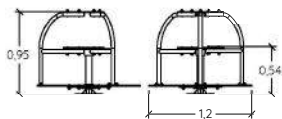

J49142®



3+

1 m

6



Origin Roundabout

J49142A	£2 273
J49142B	£2 273

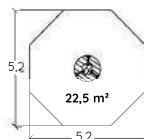
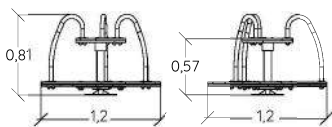

J2407



3 +

1 m

8

Fun Disc

J2407A	£3 837
J2407B	£4 330

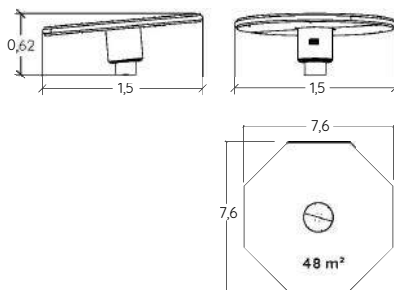

J2406



3 +





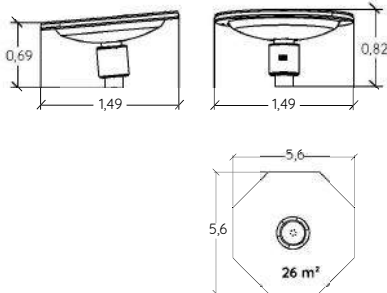

1 m

8

Wok

J2406A	£5 067
J2406B	£5 245



-  Compact composite panels
-  Stainless steel
-  Galvanised steel
-  Polyethylene
-  Robinia
-  Painted metal posts

ROTATING EQUIPMENT

MOVING EQUIPMENT

J3603

2+

0,60 m

2

Rotatwin

J3603A

£4 322

J3603B

£4 069

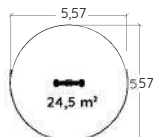

J3501

8+

0,55 m

4

Rodeoboard

J3501A

£5 020

J3501B

£5 020

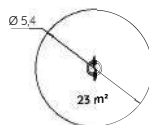
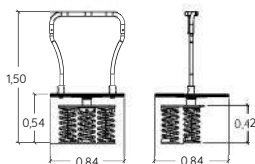

J2591

6+

1,70 m

8

Rollup

J2591A

£2 266

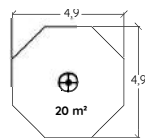
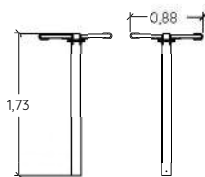

J2410

6 +

1,30 m

2

Hip Hop

J2410A

£4 609

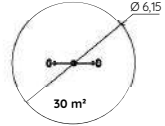
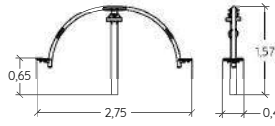

R24-ITY-724

5 - 15

1,50 m

4

Hurricane Swing

R24-ITY-724A

£6 752

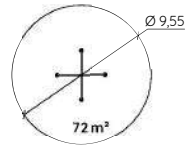
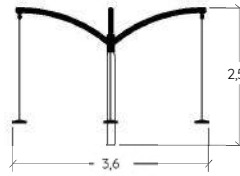

J3504-N

12 +

0,90 m

2

Turnfly

J3504A-N

£7 810

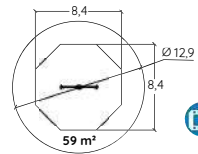
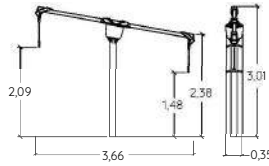

J3505

12 +

2,35 m

2

Skysurf

J3505A

£11 903

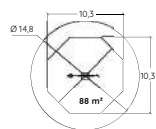
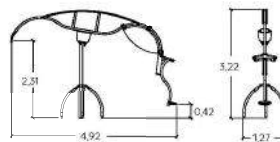

Compact composite panels

Stainless steel

Galvanised steel

Painted metal posts



CABLEWAYS
MOVING EQUIPMENT





Cableways offer an essential, fun aspect to active play areas for pre-teens and teenagers. Not only will they enjoy the thrill of gliding through space, cableways are also a great way to teach children of all ages to cooperate, take turns and share.

Young people can both challenge themselves and compete with others. They can develop their own technique and build strength and agility while they play.



J515

4 +

1 m

1



Skyrail

J515A

£7 492

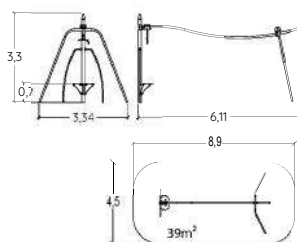

J2581-M

6 +

1,50 m

1



Aeroskate

J2581A-M

£7 438

J2581A

£7 438

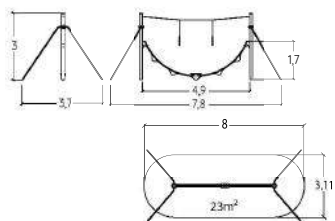

J2582-M

7 +

0,97 m

1



Aerospeed

J2582A-M

£10 286

J2582A

£11 433

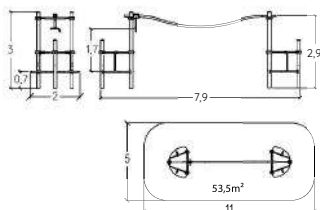

Cableway for natural slope

J512

4 +

1 m

1

J512A

£6 797

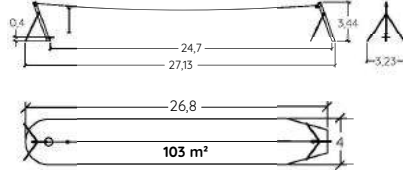

J510

4 +

1 m

1

J510A

£10 782

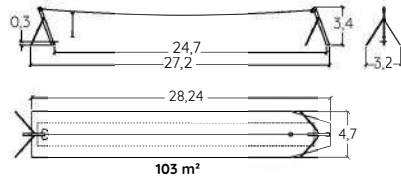

Cableway for level ground

J514

4 +

1,40 m

1

J514A

£6 948

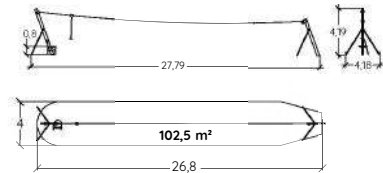

J511

6 +

1,40 m

1

J511A

£12 339

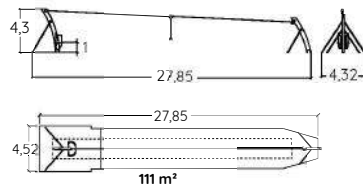
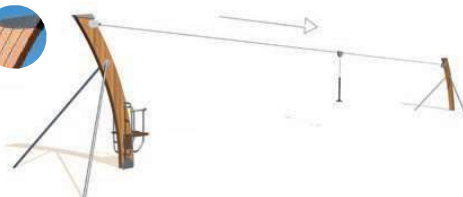

Timber posts



Stainless steel



Timber posts



Galvanised steel posts



Galvanised steel



Painted metal posts

Double Cableway for natural slope

J516

4 +

1 m

2

J516A

£14 520

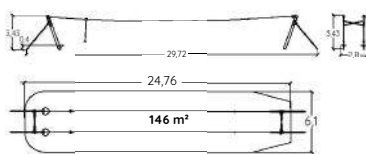

J520

6 +

1 m

2

J520A

£20 503

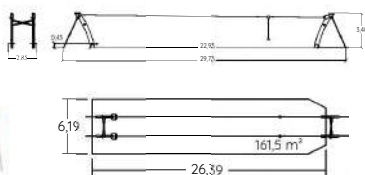

Double Cableway for level ground

J517

4 +

1,40 m

2

J517A

£14 826

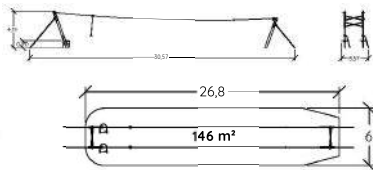
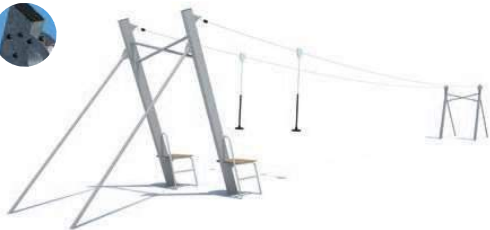

J513

6 +

1,40 m

2

J513A

£22 207

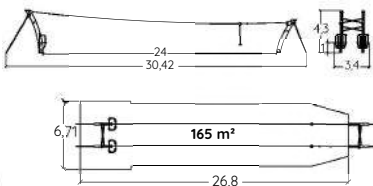
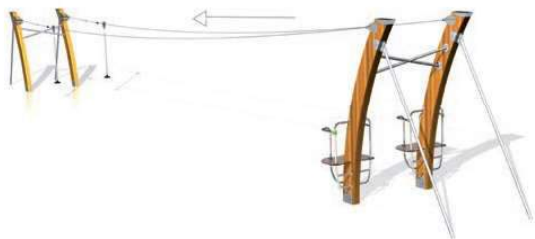

 Timber posts

 Stainless steel



Timber posts



Galvanised steel posts

 Galvanised steel

 Painted metal posts





TRADITIONAL PLAY EQUIPMENT

Playhouses	198
Swings	204
Slides	218

No playground would be complete without certain classic play items like playhouses, swings and slides. This equipment offers great places for children to play alone or with others. Other play elements offer heightened sensations that go with sliding and swinging.

Whether used as standalone items or to compliment multiplay structures, they're fundamental to any play area design.



PLAYHOUSES
TRADITIONAL PLAY EQUIPMENT

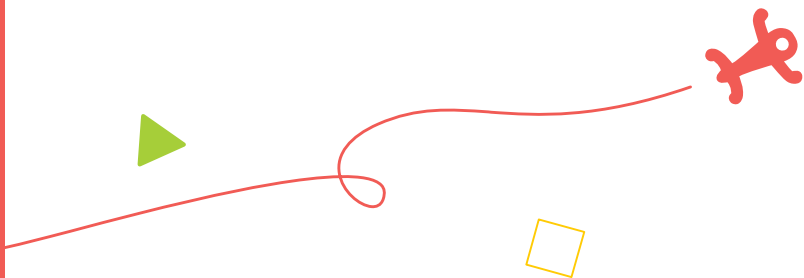



The playhouses provide wonderful places for young children to play or socialise.

Their shapes, style and cleverly designed accessories take young children into an imaginary world where they can pretend be shopkeeper, teachers or chefs...

PLAYHOUSES

TRADITIONAL PLAY EQUIPMENT

J256



1+



<math><0,60\text{ m}</math>



6

Climbing Hut

J256A	£2 299
J256B	£2 299

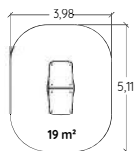
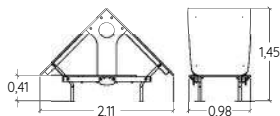

J254



2+

1,50 m

14

Climbing Hut with climbing roof

J254A	£2 479
J254B	£2 479

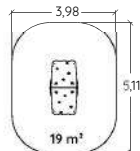
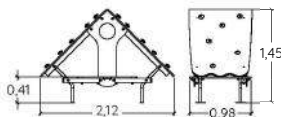

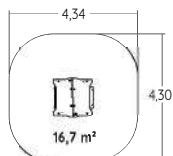
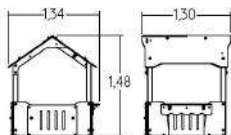
NEW**J235®****1+****<0,60****10****J235®****J236®***The Cottage*

J235A	£2 772
J235B	£2 772
J236A	£2 780
J236B	£2 780

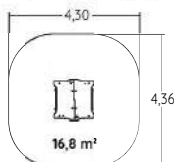
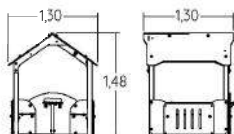
NEW**J237®****1+****<0,60****10****J237®****J238®***The Furnished Cottage*

J237A	£3 200
J237B	£3 200
J238A	£3 202
J238B	£3 202

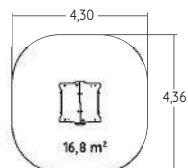
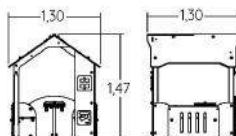
NEW**J239®****1+****<0,60****10***The Fun Cottage*

J239A	£3 627
J239B	£3 627

Compact composite panels

Galvanised steel

Painted metal posts

PLAYHOUSES

TRADITIONAL PLAY EQUIPMENT

J220®



1+

<0,60 m

5



The Little House

J220A	£2 031
J220B	£2 031

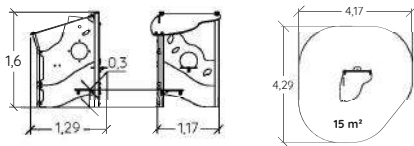

J232®



1+

<0,60 m

11



The Fun Little House

J232A	£3 037
J232B	£3 037

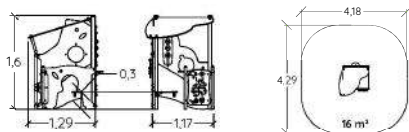

J223®



1+

<0,6 m

15

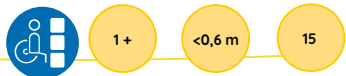

The Hiding Little House

J223A	£5 114
J223B	£5 114

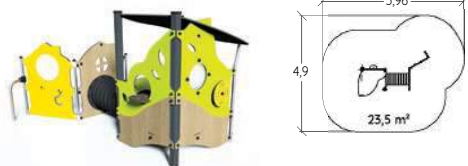
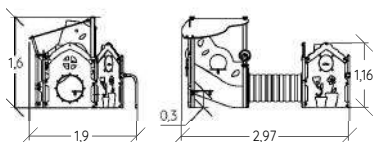

Find out more about the other 13 « Playhouses » products on our website.



J234®



1+

<0,60 m

18

The Hamlet of the Elves

J234A

£6 340

J234B

£6 340

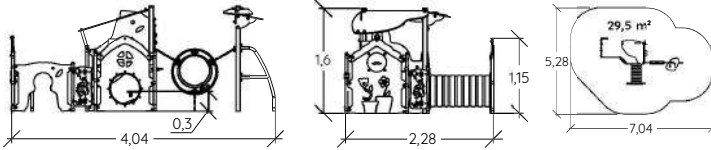

J225®



1+

<0,60 m

35

The Village of the Elves

J225A

£11 425

J225B

£11 425

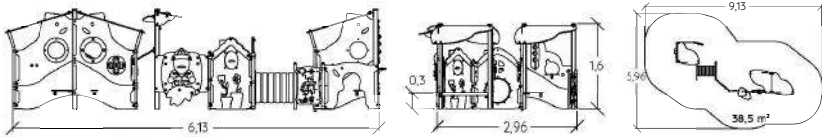

+ Connectable playhouses with the Diabolo Baby range p.20 to 25.

Compact composite panels

Stainless steel

Painted metal posts



SWINGS
TRADITIONAL PLAY EQUIPMENT





Swings are a traditional play item and an all-time favourite that has given many generations of children the sensation of flying through the air and the joy of seemingly touching the sky! Although the sheer pleasure that comes from swinging remains unchanged, swings are now available in all shapes and sizes.

Wraparound seats or braided rope seats just 40 cm above the ground guarantee safety for the youngest users. Older children can have fun together on the 1.20 metre diameter pod swing or the braided balancing rope. The hexagonal swing with its six sets of seats offers children an even greater set of challenges.

SWINGS

TRADITIONAL PLAY EQUIPMENT



1



3



5



2



4



6

1 Swing chains. Galvanised steel overmoulded with rubber. (pod swing)

3 Rotation system fitted with bearings.

5 PVC sliding rings prevent wear on the metal parts. (pod swing)













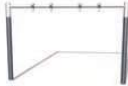

2 The **rotation system** enables swinging in both directions. A safety chain strengthens the pod support. (pod swing)

4 Anti-wrap round rotation system. Made of polyamide parts and stainless steel fixings.

6  The **inclusive deck-chair seat** features a stainless steel frame and a rubber seat pad. The swing chains are made of stainless steel.



YOUR BESPOKE SWING

<p>1 CHOOSE YOUR STYLE OF SWING</p>	 <p>Glulam or Robinia Swing</p>	 <p>Metal swing Galvanised steel</p>	 <p>Metal swing Painted galvanised steel</p>	 <p>Metal swing Green Kanopé style</p>	 <p>Metal swing Timber-look Kanopé style</p>
<p>2 DETERMINE YOUR HEIGHT**</p>	<ul style="list-style-type: none"> • Low • Medium • High 	<ul style="list-style-type: none"> • Low • Medium 	<ul style="list-style-type: none"> • Medium 		
<p>3 ADD YOUR SEATS</p>	<p>One seat</p>		<p>Two seats</p>		
					
<p>Pod seat</p>	<p>Braided rope seat</p>	<p>Classic seat</p>	<p>Early years cradle seat 3+</p>	<p>Inclusive deck-chair seat</p>	<p>Double seat</p>
					

Certain combinations may not be possible. Please get in touch with your Proludic contact for further information.

* The Inclusive and Duo seats cannot be used in a double combination (twice on the same swing frame).

** Height : Small = 2 metres / Medium = 2,20 to 2,50 metres / Tall = 2,8 metres

Examples of possible combinations



Metal swing
Timber-look Kanopé style
+
Medium
+
Double seat
+
Classic seat



Metal swing
Painted galvanised steel
+
Medium
+
Classic seat
+
Early years cradle seat 3+



SWINGS

TRADITIONAL PLAY EQUIPMENT

J450



2+

1,20 m

2

J450A

£1 777

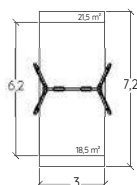
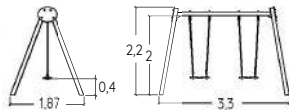

Check out the Origin' J490 swing with the same combination of seats, p. 152

J468



1+

1,20 m

2

J468A

£2 029

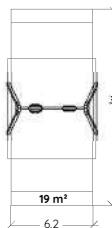
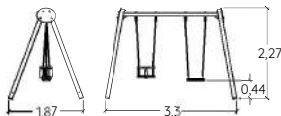

Check out the Origin' J489 swing with the same combination of seats, p. 152

J440



2+

1,55 m

5

J440A

£4 261

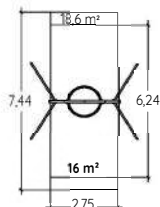
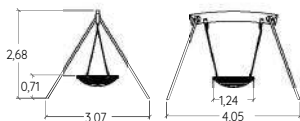

Check out the Origin' J491 swing with the same combination of seats, p. 152

J3960

1 - 3

0,90 m

1

J3960A

£1 094

J3960B

£1 325

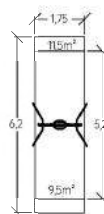
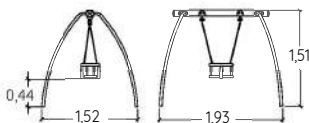

J443®



2 +

0,94 m

5

J443A

£2 489

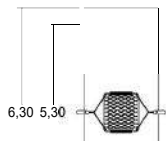

14 m²

2,25

J445®



2 +

1,42 m

5

J445A

£3 388

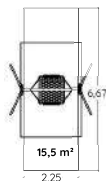
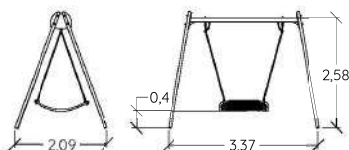

15,5 m²



Compact composite panels

Galvanised steel

Timber posts

Painted metal posts

Stainless steel



J472



2+

1,20 m

2

J472A

£1 559

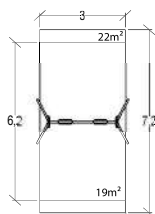
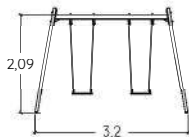

J473



1+

1,20 m

2

J473A

£1 701

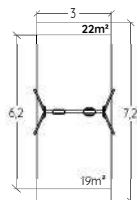
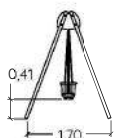
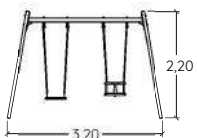

J476



2+

1,20 m

2

J476A
J477A

£1 886

£1 568

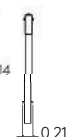
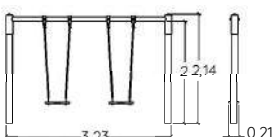

J438



1+

1,37 m

2

J438A

£2 291

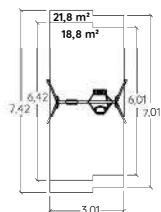
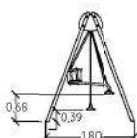
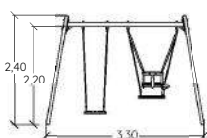

J484



1+

1,20 m

2

J484A

£1 742

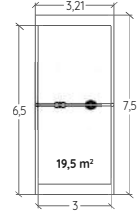
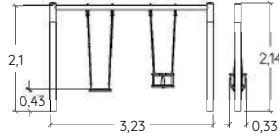

J433-C®



1+

1,28 m

2

J433A

£2 549

J433A-C

£2 662

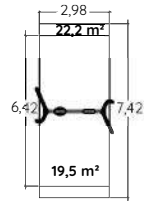
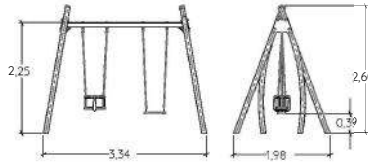

J432®



2+

1,28 m

2

J432A

£2 390

J432A-C

£2 498

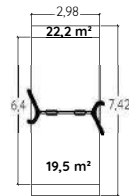
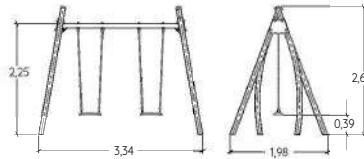

- Compact composite panels
- Galvanized steel

- Painted metal posts
- Painted metal posts

- Painted metal posts (Timber look colour)

- Anti-wrapping system
- Fixed system

SWINGS

TRADITIONAL PLAY EQUIPMENT

J441



2+

1,55 m

5



J441A

£3 254

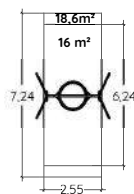
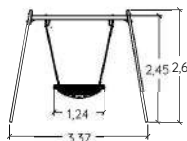
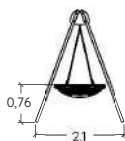

Evergreen Kanopé Swing

J435®



2+

1,46 m

5



J435A

£3 710

J435A-C

£3 845

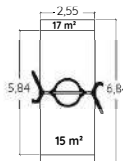
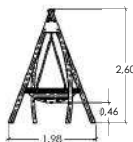

J487



2+

1,55 m

5



J487A

£4 090

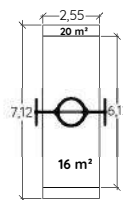

J496



1+

1,55 m

7



J496A

£5 610

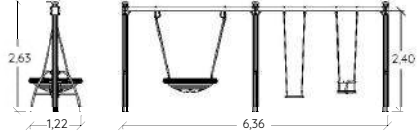
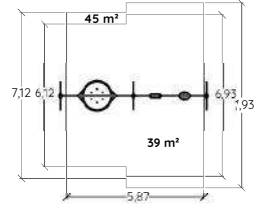

J493



1+

1,55 m

9



J493A

£7 267

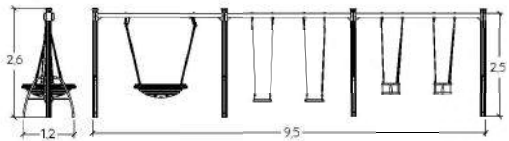
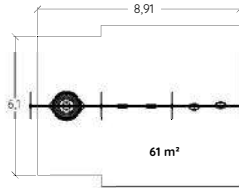

J444®



2+

1,60 m

5



Pendulum Swing

J444A

£8 234

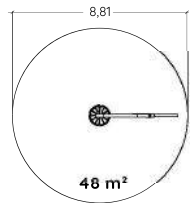
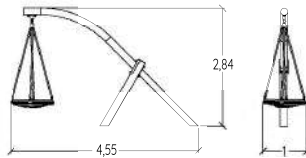

Find out more about the other 23 « Swings » products on our website.



Compact composite panels
Galvanised steel

Painted metal posts
Painted metal posts

Painted metal posts (Timber look colour)

SWINGS

TRADITIONAL PLAY EQUIPMENT



J442-M®

2 +

1,50 m

4

■	J442A-M	£5 698
■	J442A	£6 208

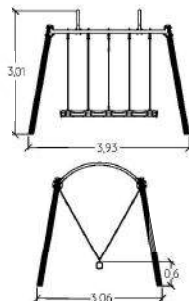
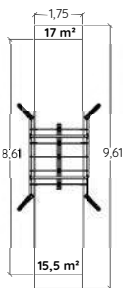

J499

2 +

1,50 m

4

■	J499A	£5 804
---	-------	--------

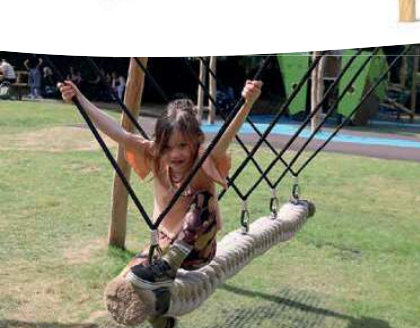
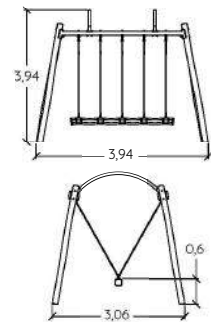
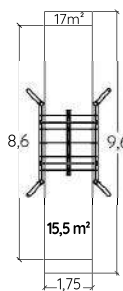

R49-IPY-1611



2 +

1,30

1

Inclusive Swing

R49-IPY-1611A

£8 955

R49-IPY-1611B

£8 955

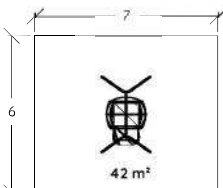
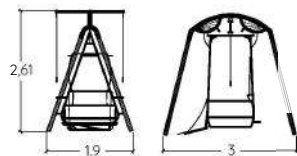

Recommended installation



J483



3 +

1,40 m

6

J483A

£5 887

J482A

£7 633

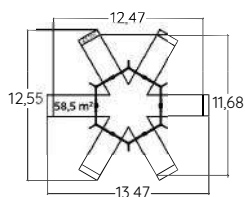
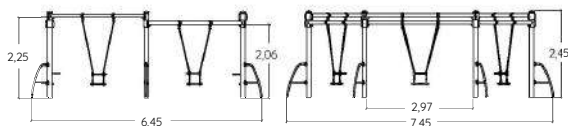

Galvanised steel



Painted metal posts



Timber posts



Robinia



Anti-wrapping system



Fixed system

SWINGS

TRADITIONAL PLAY EQUIPMENT







SLIDES
TRADITIONAL PLAY EQUIPMENT

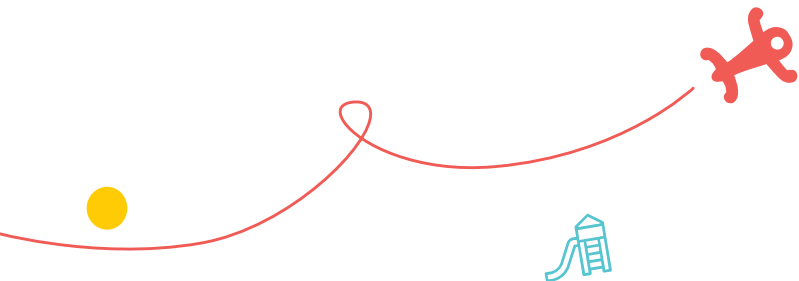



Forever popular, slides are an integral element of a child's world.

For younger children, there are wider steps that provide a stable base for safe access, while older children climb up a ladder.

Straight or wavy slides, stainless steel tubular structures, polyethylene Kayak slides – the variety of shapes, lengths and materials provide multiple solutions for developing a play area and adapting it to any type of environment.

SLIDES

TRADITIONAL PLAY EQUIPMENT

J38700®



0,5 +

1 m

5



J38700A



J38700A-C*

Diabolo Baby Slide

J38700A	£3 442
J38700B	£3 442

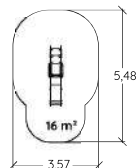
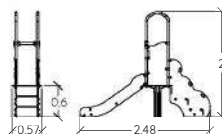

J1012-P®



1 - 5

1 m

5



Mini Slide - polyester

J1012A-P	£1 442
J1012A	£1 442

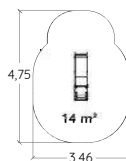
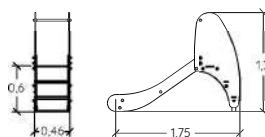

J1069-P®



2 - 6

1 m

5



Slidy - polyester

J1069A-P	£2 257
J1069A	£2 257
J1069B-P	£2 257
J1069B	£2 257

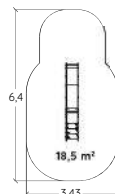
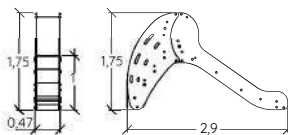

J1010

2 +

1,07 m

7



Medium Green Slide

J1010A	£1 554
--------	--------

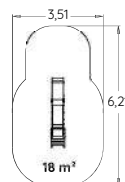
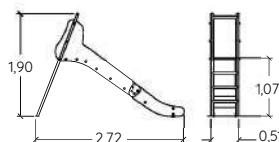

J1011

2+

1,37 m

8



J1011A

J1011A-GA

Green Slide

J1011A	£1 797
J1011A-GA	£3 506

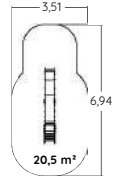
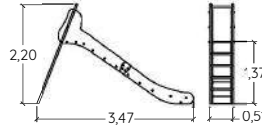

J1056

3+

1,77 m

5



Maxi Slide

J1056A	£3 574
--------	--------

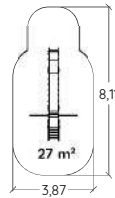
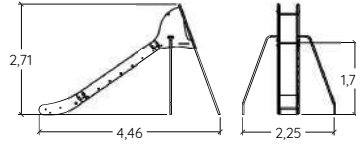

J1057

4+

2,20 m

5



Surf Slide

J1057A	£5 041
--------	--------

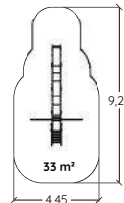
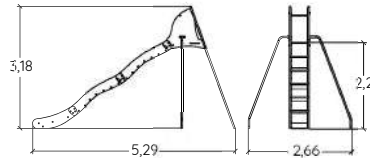

NEW

J4010®

2+

1 m

8



Elephant slide

J4010A	£5 836
J4010B	£5 836

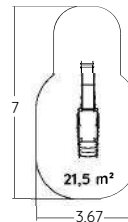
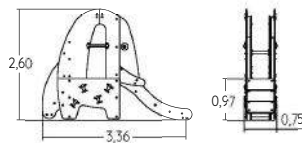

Compact composite panels

Stainless steel

Polyester

Painted metal posts

SLIDES

TRADITIONAL PLAY EQUIPMENT

J1110



2 +

1 m

3

Inclusive Embankment Slide

J1110A

£4 549

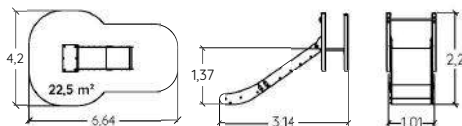

J1120



2 +

1 m

3

Kayak Embankment Slide

J1120A

£5 073

J1121A

£5 846

J1122A

£6 874

J1123A

£7 647

J1124A

£8 418

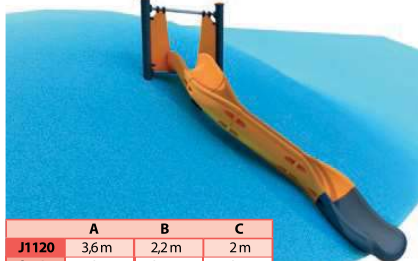

	A	B	C
J1120	3,6m	2,2m	2 m
J1121	4,3m	2,7m	2 m
J1122	5,1m	3,3m	2 m
J1123	5,6m	3,8m	2,6m
J1124	6,3m	4,4m	2,6m

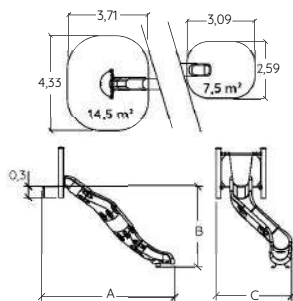

J1130



2 +

1 m

4

Tubeular Embankment Slide

J1130A

£10 902

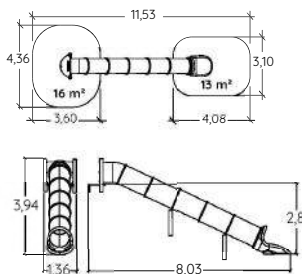

Find out more about the other 11 « Slides » products on our website.



Compact composite panels

Rotary moulded polyethylene

Painted metal posts

Stainless steel







CLIMBING & BALANCING EQUIPMENT

Trails	226
Trampolines	234
Rope structures	236
Climbing structures	244

Balancing and climbing equipment encourages children to test their agility, spatial confidence and motor coordination.

ACTiNinja obstacle courses, urban parkour-inspired modules, pyramids, trampolines, climbing walls... the wide variety of equipment present different levels of difficulty appropriate to the children's age and abilities.



TRAILS

CLIMBING & BALANCING EQUIPMENT





Trails promote sequenced movements and positions that will help children develop their motor skills. Crossing a beam or vertical ramp, moving forward across unstable steps or sloping features, climbing, crawling, hanging... children learn how to control their body in the air, coordinate their movements more effectively and develop their concentration.

Trails offer varying levels of difficulty, prompting children to take risks and push themselves beyond their limits. They also encourage children to play together in groups as they try to see who can complete the course in the fastest time.

TRAILS

CLIMBING & BALANCING EQUIPMENT



J5406-M

2 - 8

<0,60 m

4

J5406A-M

£1 796

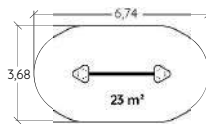
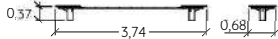

J5401-M

2 - 8

<0,60 m

10

J5401A-M

£3 434

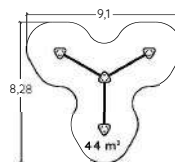
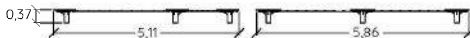
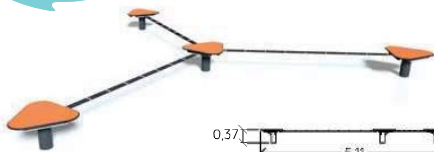

J5402-M

2 - 8

<0,60 m

25

J5402A-M

£9 085

J5402A

£9 668

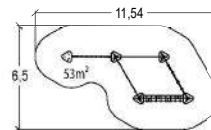
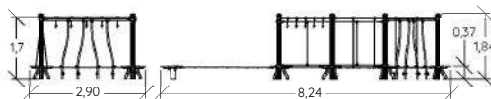

J5400-M

2 - 8

0,65 m

24

J5400A-M

£10 181

J5400A

£11 048

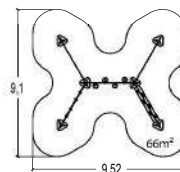
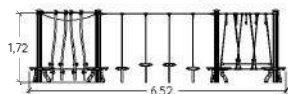

J5403-M

2 - 8

<0,60 m

37

J5403A-M

€11 083

J5403A

€11 808

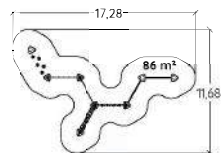

J5407-M

2 +

<0,60 m

11

J5407A-M

€6 995

J5407A

€7 574

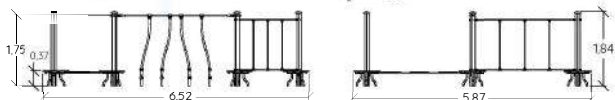
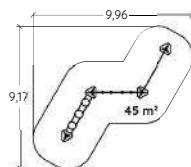

J5408-M

2 +

<0,60 m

11

J5408A-M

€8 633

J5408A

€9 202

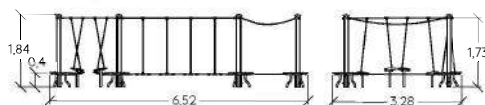
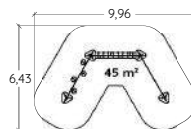

Find out more about the other 34 « Trails » products on our website.



Painted metal posts

Stainless steel

Timber posts

Polyethylene

Design examples



6+ M-SIZED NINJA TRAIL

Ninja M £13 614

Price excluding installation and surfacing

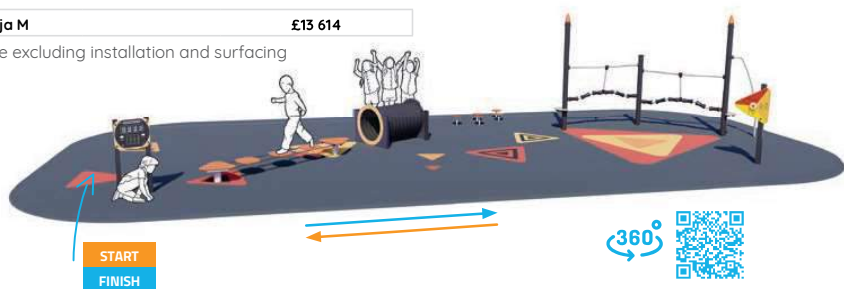

8+ L-SIZED NINJA TRAIL

Ninja L £24 722

Price excluding installation and surfacing

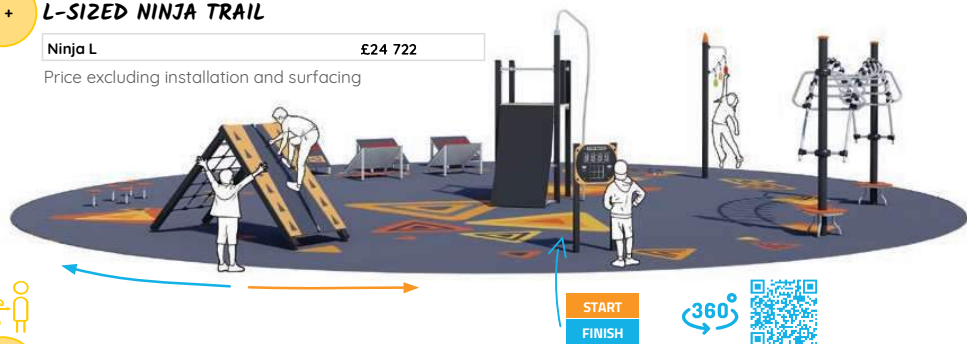

8+ XXL-SIZED NINJA TRAIL

Ninja XXL £45 154

Price excluding installation and surfacing



TRAILS

CLIMBING & BALANCING EQUIPMENT



J5903® 6+ < 0,60 m 4

1=1,95 m
2=0,70 m
3=0,27 m



Steps

J5903A £820

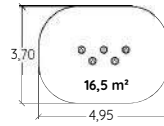

J5907® 6+ < 0,60 m 1

1=0,71 m
2=0,12 m
3=3,21 m



Vertical jump activity

J5907A £843

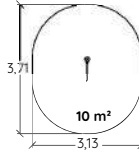

J5912® 6+ < 0,60 m 1

1=0,67 m
2=0,16 m
3=1,81 m



Exercise panel

J5912A £1 265

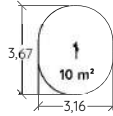

J5905® 6+ < 0,60 m 2

1=3,74 m
2=0,68 m
3=0,37 m



Unstable bridge

J5905A £2 079

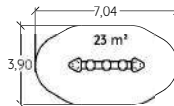

J5902® 6+ 0,60 m 1

1=1,38 m
2=1,17 m
3=1,04 m



Tunnel

J5902A £2 594

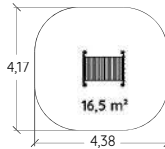

J5914® 6+ < 0,60 m 1

1=0,61 m
2=0,11 m
3=1,45 m



Stopwatch panel

J5914A £2 671

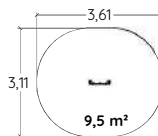

Compact composite panels

Stainless steel

Painted metal posts

Polyethylene

TRAILS

CLIMBING & BALANCING EQUIPMENT

ACTI'Ninja®
BY PROLUDIC



J5909®

6 +

1,10 m

3

1=2,35 m
2=1,33 m
3=1,15 m



Suspended tunnel

J5909A

£3 810

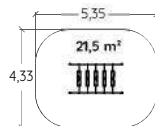

J5910®

6 +

< 0,60 m

10

1=8,22 m
2=3,28 m
3=0,37 m



Slackline

J5910A

£4 105

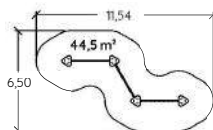

J5911®

6 +

1 m

4

1=4,93 m
2=1,37 m
3=3,01 m



Winding tubes

J5911A

£4 186

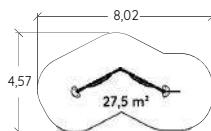

J5904®

6 +

2,70 m

7

1=5,34 m
2=1,61 m
3=3,01 m

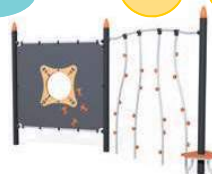

Climbing module

J5904A

£6 203

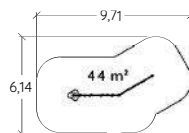

J5913®

6 +

1,55 m

4

1=10,51 m
2=3,37 m
3=3,21 m

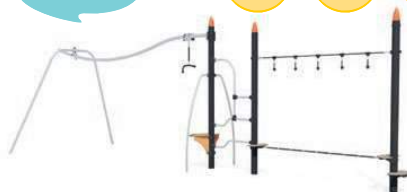

Aerial crossing

J5913A

£9 876

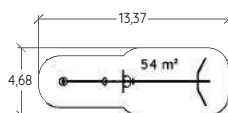

J5906®

8 +

1,65 m

2

1=3,11 m
2=1,08 m
3=1,64 m



Climbing slope

J5906A

£3 544

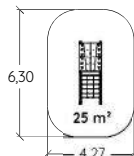

J5908®

8 +

2,40 m

4

1=5,24 m
2=1,09 m
3=2,93 m

Monkey bar archway

J5908A

£4 756

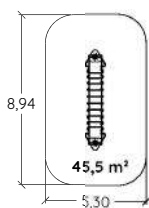

J5901®

8 +

0,60 m

2

1=3,71 m
2=2,03 m
3=0,54 m

Slanted steps

J5901A

£5 390

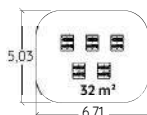

J5915®

8 +

2,40 m

4

1=2,06 m
2=1,67 m
3=3,50 m

Ramp

J5915A

£6 698

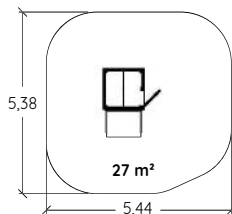

 Compact composite panels

 Stainless steel

 Painted metal posts

 Galvanized steel

 Polyethylene



TRAMPOLINES

CLIMBING & BALANCING EQUIPMENT

Trampolines give children wings and are the ultimate in fun!

Trampolines are simple to use and available to children aged 3 and above. They develop motor skills, coordination, balance and muscle strength. In the air, children become aware of how their body feels in the air and improve their posture.

Trampolines rightly belong in any inclusive play area. Ground-level trampolines are protected by a frame with rounded edges and ensure easy access to the centre for children in wheelchairs with a helping hand from a carer or friend, so that they too can gently experience the sensation of bouncing.

The steady bouncing motion of the trampoline can have a calming effect on over-stimulated and autistic children.

R34-ETP-000



3+

1 m

1

Square Trampoline

R34-ETP-000A

£3 487

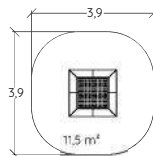
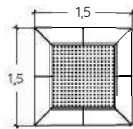
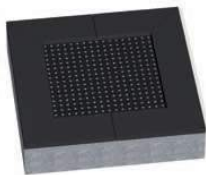

R34-ETP-010



3+

1 m

1

Round Trampoline

R34-ETP-010A

£3 955

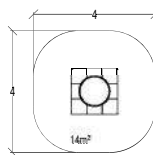
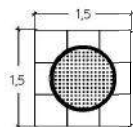
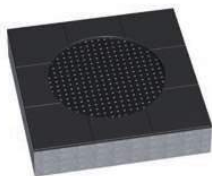

R34-ETP-500



3+

1 m

1

Large Square Trampoline

R34-ETP-500A

£4 773

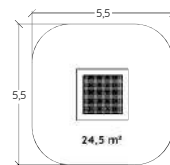
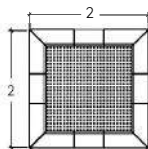
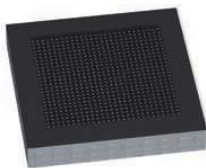

R34-ETP-004



3+

1 m

2

Rectangle Trampoline

R34-ETP-004A

£10 367

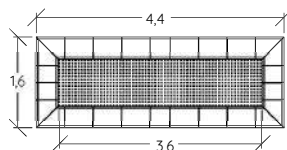
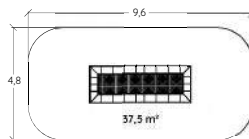

 Galvanised steel

 Rubber slab

 The bouncing surface is composed of straps reinforced with steel threads attached to the frame with steel springs



ROPE STRUCTURES

CLIMBING & BALANCING EQUIPMENT





Designed in 3D, rope structures allow children to take complete ownership of the space, making use of both the peripheral and inside sections of the equipment. Crossing requires concentration and good hand-foot coordination to best manage the instability of the ropes and, in some cases, the suspended stepping stones at the centre of the structures.

By going higher, children expand their perception of space. Although the same climbing techniques are used from start to finish, the most valuable lesson for children will be overcoming their fear of heights.

Rope structures can be connected to other types of play equipment, such as slides and climbing walls, or incorporate aerial trails to move from one module to the next without putting a foot on the ground.

ROPE STRUCTURES

CLIMBING & BALANCING EQUIPMENT



J60001®

5 +

1,50 m

20

J60001A

£10 136

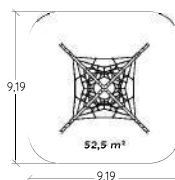
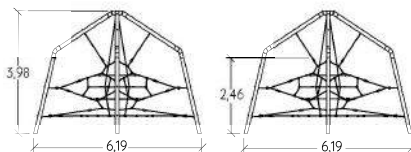
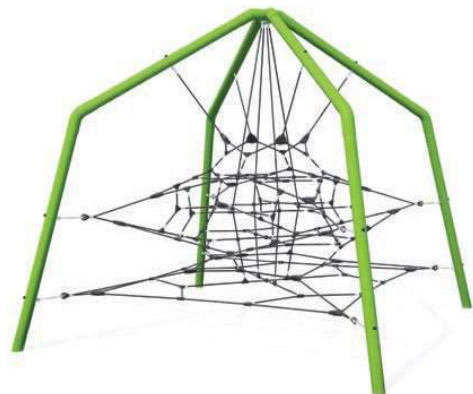

J4807

5 +

2,50 m

15

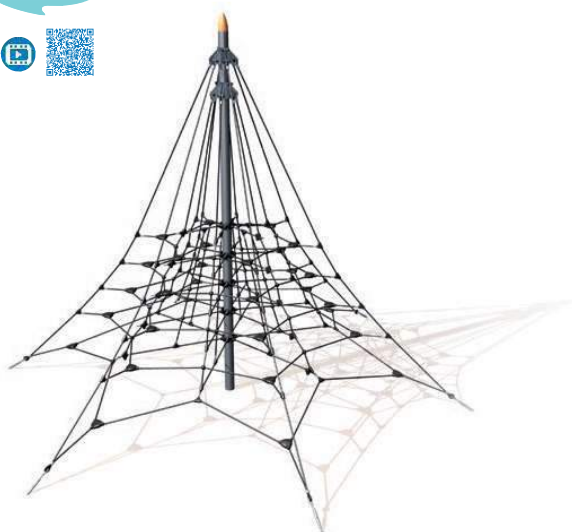

Single Pyramid

J4807A £10 198

J4807B £10 394

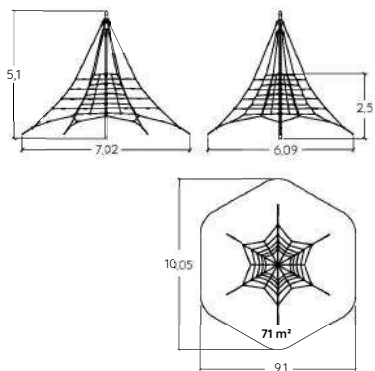

J4811

6 +

2,60 m

35

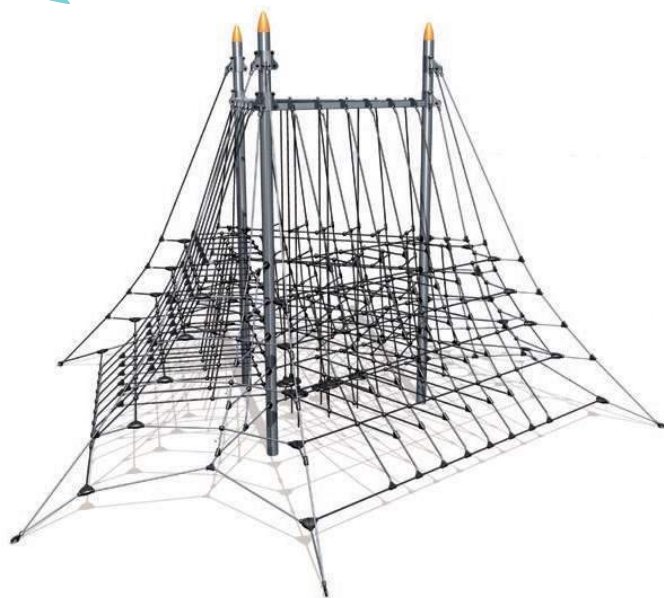

Triple Pyramid

J4811A £25 773

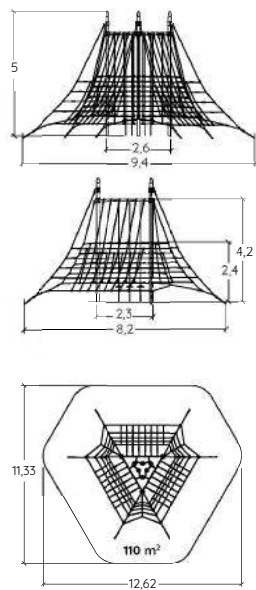

Painted metal posts

Painted metal posts

ROPE STRUCTURES

CLIMBING & BALANCING EQUIPMENT



J4815

3+

0,97 m

12

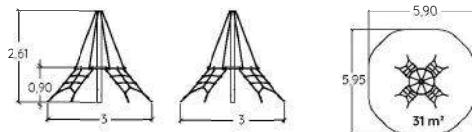

Small Pyramid

J4815A	£3 946
J4815B	£3 946

R48-IPY-702

3+

1,33 m

6



Rotating Pyramid

R48-IPY-702A	£4 387
--------------	--------

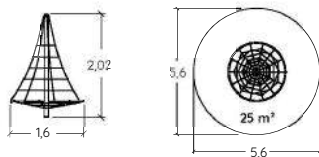

J57011®

3+

2 m

15



J57011A	£12 697
---------	---------

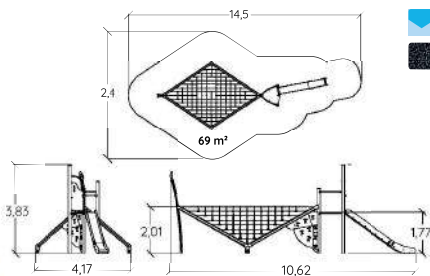

J57006



3+

2 m

20

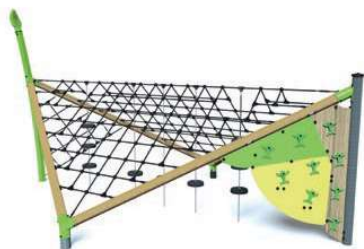

J57006A	£13 175
---------	---------

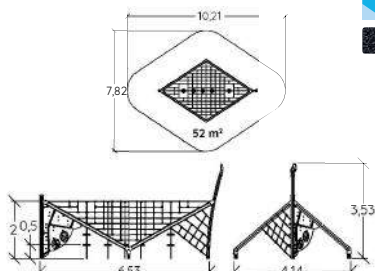

J57008



3 +

2 m

64

J57008A

£36 065

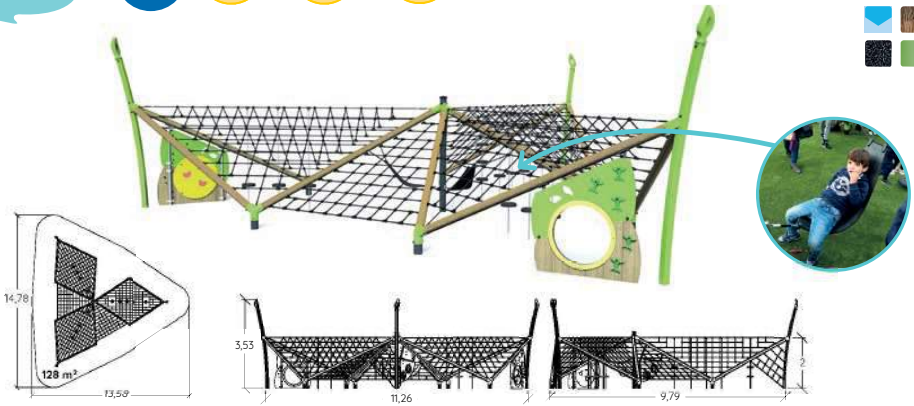

J57003



5 +

2 m

15

J57003A

£10 238



Compact composite panels

Painted metal posts

Timber posts

ROPE STRUCTURES

CLIMBING & BALANCING EQUIPMENT



6+



2,50 m



35

J4800A

£45 953

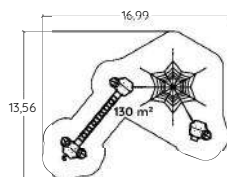
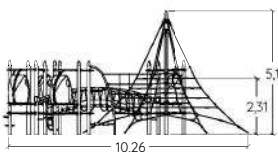
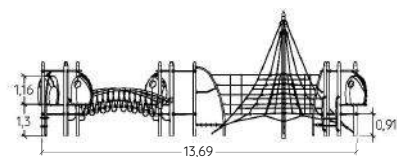
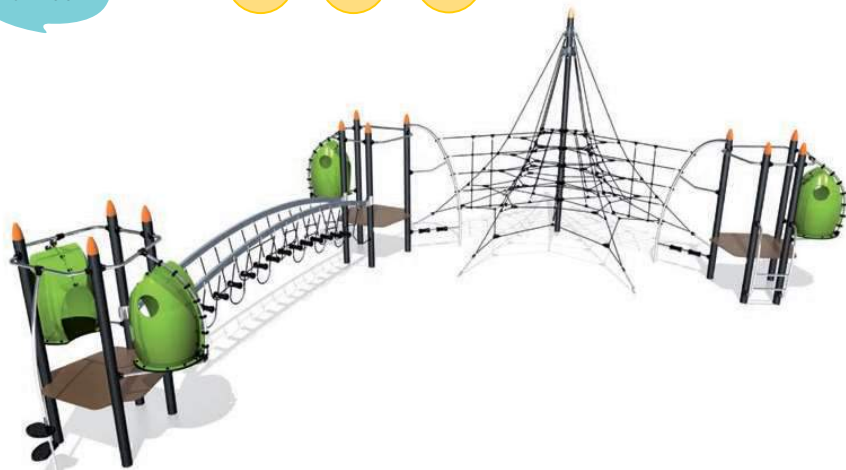

J4801

6 +

2,90 m

60

J4801A

£88 841

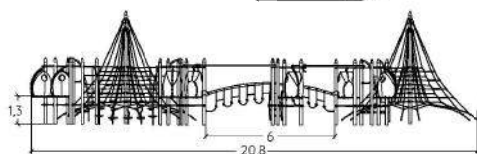
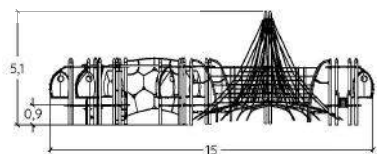
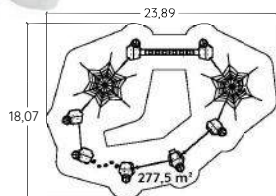

Find out more about the other 33 « Rope structures » products on our website.



Painted metal posts

Stainless steel



CLIMBING STRUCTURES

CLIMBING & BALANCING EQUIPMENT





Climbing structures attract children and teens who love climbing and playing at height.

Nets, climbing walls, ladders, horizontal bars, a 4 metre-high pole... the equipment is varied and presents different levels of difficulty and technique appropriate to the age of the users. Users are required to move across horizontal, vertical and sloping surfaces, which calls for balance, agility and coordination.

These structures also encourage children to play together. They can compare their skills, throw down the gauntlet or help each other overcome a difficulty and progress along the structure. The enjoyment of playing comes top of the list, which promotes interaction and socialisation.

CLIMBING STRUCTURES

CLIMBING & BALANCING EQUIPMENT

J1661-M



2+

1,60 m

6



J1661A-M	£2 511
J1661B-M	£2 511
J1661A	£2 250
J1661B	£2 250

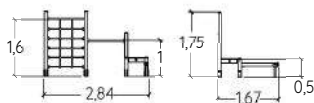
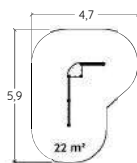

J1662-M



2+

1,70 m

8



J1662A-M	£2 893
J1662B-M	£2 893
J1662A	£2 700
J1662B	£2 700

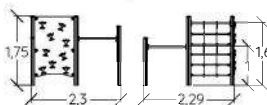
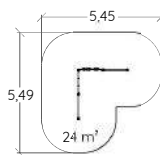

J3800-M



3+

2,10 m

10



Tripod

J3800A-M	£3 095
----------	--------

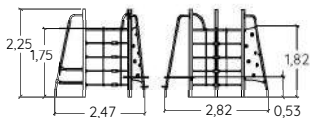
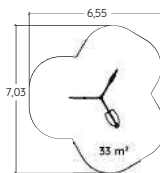

J1610-M



5 +

2,40 m

9



J1610A-M	£5 257
J1610B-M	£5 257
J1610A	£4 534
J1610B	£4 534

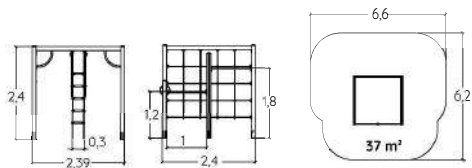

J1605-M



5 +

2,40 m

14



J1605A-M	£6 344
J1605B-M	£6 344
J1605A	£4 885
J1605B	£4 885

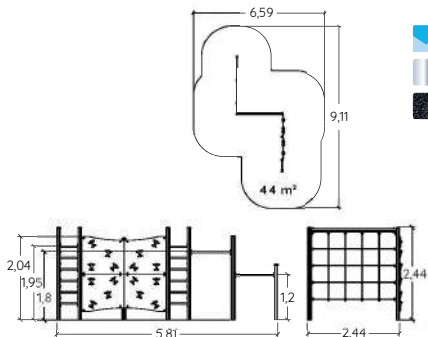

J1608-M

5 +

2,40 m

20



J1608A-M	£13 793
J1608B-M	£13 793
J1608A	£9 905
J1608B	£9 905

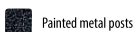
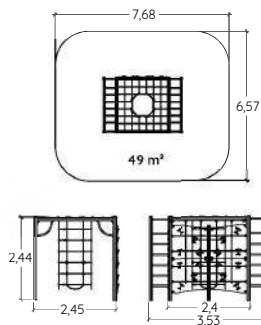

CLIMBING STRUCTURES

CLIMBING & BALANCING EQUIPMENT



J410

3 +

2,70 m

11

Apollo

J410A

£3 505

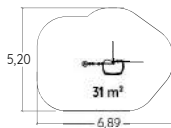
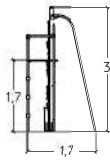
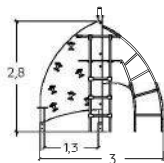

J415

7 +

2,90 m

11

Golgoth

J415A

£6 300

J415B

£6 300

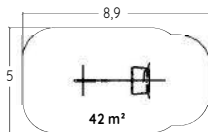
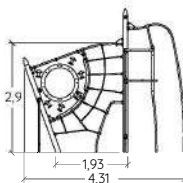

J3503

14 +

2,80 m

1

Altima Climbing Mast

J3503A

£3 206

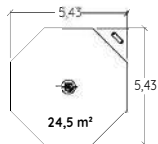
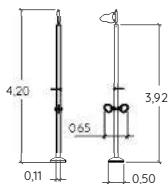

J48304

6 +

2,90 m

15

J48304A

£10 492

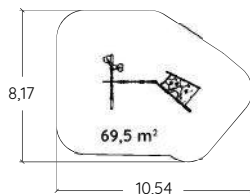
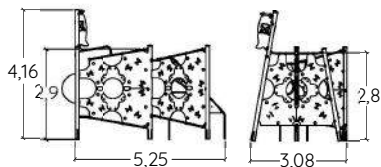

J48305

6 +

2,90 m

20

J48305A

£10 910

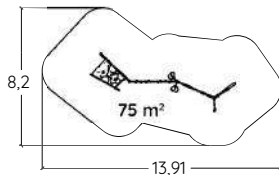
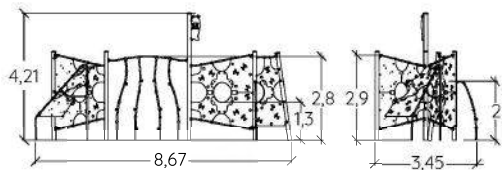

Find out more about the other 28 « Climbing structures » products on our website.



 Compact composite panels

 Stainless steel

 Plywood

 Painted metal posts

 Galvanised steel

CLIMBING & BALANCING EQUIPMENT









EDUCATIONAL & SENSORY EQUIPMENT

GymLudic® trail & Balancing modules	254
Play panels, Audio & Musical play	258
Sand play, water play and gardening	266
Interactive play	272

Educational and sensory play helps children grow and improve their abilities by nurturing their cognitive, creative and social skills.

Trails hone their motor skills and encourage them to take risks. Play panels develop concentration and observation through play. Playing with sand, water and soil stimulates the senses, increases motor skills and inspires creativity in the youngest children. Musical play activities help activate children's hearing. Interactive play activities arouse keen observation, movement skills and quick response.

All these play elements encourage children to socialise through play.



GYMLUDIC® TRAIL & BALANCING MODULES
EDUCATIONAL & SENSORY EQUIPMENT





The GymLudic® trail and the balancing modules are ideally suited to educational programmes aimed at scaling up skills development and learning in young children through a series of actions requiring increasingly complex and coordinated motor skills. They encourage children to enrich and improve a wide range of abilities, including locomotor skills, balance and coordination, and how to conquer their fears.

GymLudic® is an educational play structure featuring up to 80 activities for stimulating children's motor skills.

This system is supplied as a compact, folding box and provides a number of exercise opportunities involving balancing, jumping, crossing, throwing and space management. Activities are concentrated in and around the box. They can be sequenced to form a trail or performed individually depending on the required learning objectives.

Thanks to its modular design and various accessories, teachers can provide scalable exercises with different levels of difficulty. Children can therefore enhance their motor and psychomotor skills over time.

The shape and complexity of the different balancing modules allow for a wide variety of crossing activities.



GYMLUDIC® TRAIL & BALANCING MODULES

EDUCATIONAL & SENSORY EQUIPMENT

GYMLUDIC®



Compliant with the requirements of pre-school teaching programmes, GymLudic® is an educational play structure that comes as a compact, easy-to-handle folding box. It can be installed either indoors or outdoors depending on the season.

J51001®



2 - 6



0,90 m



15

GymLudic®

J51001

£16 475

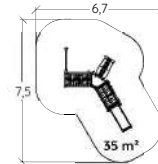
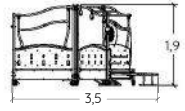
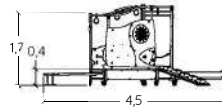

J51000®



2 - 6

1,95 m

20

GymLudic®

J51000

£24 889

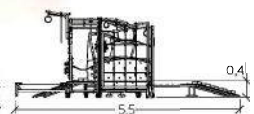
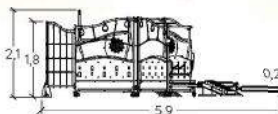
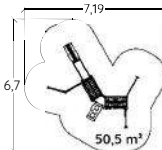



J10

2 + 0,30 m 2

1=1,70 m
2=0,07 m
3=0,32 m

Balance Beam

J10A £356

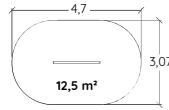

J13

2 + 0,30 m 2

1=1,62 m
2=0,35 m
3=0,30 m

Winding Path

J13A £408

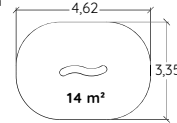

J14

2 + 0,30 m 2

1=1,18 m
2=0,25 m
3=0,30 m

Rocking Path

J14A £440

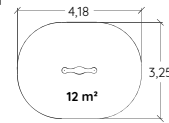

J12

2 + 0,45 m 2

1=1,54 m
2=0,18 m
3=0,44 m

Little Steps

J12A £620

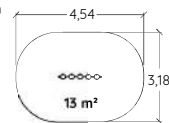

J16

2 + 0,45 m 12

1=2,44 m
2=2,12 m
3=1,22 m

Tightrope Circuit

J16A £1 370

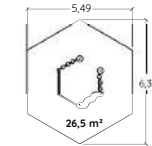

J09

2 + 0,45 m 10

1=3,20 m
2=2,90 m
3=0,40 m

Balance Circuit

J09A £2 119

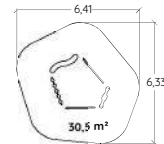

Compact composite panels



Stainless steel



Plywood



Timber posts



Rotary moulded polyethylene



Painted Aluminum



PLAY PANELS, AUDIO & MUSICAL PLAY
EDUCATIONAL & SENSORY EQUIPMENT





Engaging and fun, children enjoy using interactive play panels like Sensory Flowers and Tubophones.

Understanding play activity instructions on the panels help develop their observation and analysis skills. Performing the activities demands concentration and thought. It helps develop hand-eye coordination and strengthens their ability to plan.

Musical play activities stimulate their auditory perception and helps develop creativity and encourage interaction with other children.

PLAY PANELS, AUDIO & MUSICAL PLAY

EDUCATIONAL & SENSOY EQUIPMENT

G3421

(Ø 40 x 900 mm)

G3422 (Ø 40 x 1 130 mm)
G3423 (Ø 40 x 1 420 mm)

Posts sold separately

G3421A	£176
G3422A	£176
G3423A	£189

Example with 3 play panels



G3424

(70 x 70 x 900 mm)

G3425 (70 x 70 x 1 150 mm)
G3426 (70 x 70 x 1 420 mm)

Posts sold separately

G3424A	£183
G3425A	£198
G3426A	£212

Example with 3 play panels

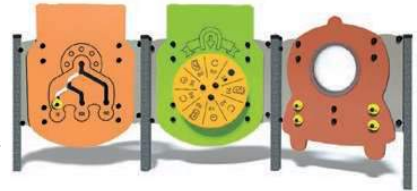

J3406

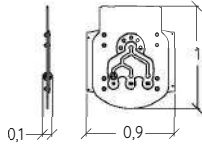
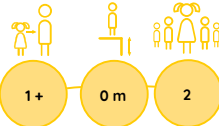

Installed on G3421/G3424 posts

Patchinko Panel

J3406 £752

J3402

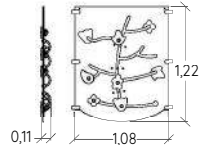
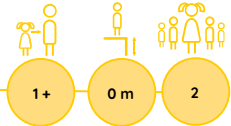

Installed on G3423/G3426 posts

Flower Panel

J3402 £769

J3407

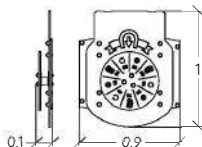

Installed on G3421/G3424 posts

Lottery Panel

J3407 £937

J3401

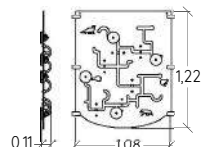

Installed on G3423/G3426 posts

Animal Panel

J3401 £1 177

J3412



1+

0 m

2



Installed on G3421/G3424 posts

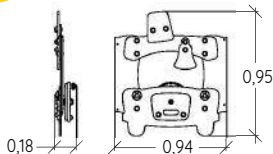

City Panel

J3412

£956

J3413



1+

0 m

2



Installed on G3421/G3424 posts

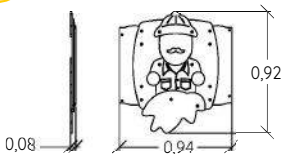

Adventure Panel

J3413

£1 002

J3411



1+

0 m

2

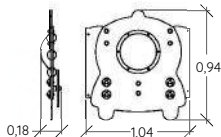

Installed on G3421/G3424 posts

Metropolis Panel

J3411

£1 022

J3417



1+

0 m

2

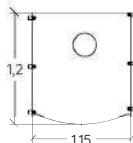

Installed on G3423/G3426 posts

Knight Panel

J3417

£2 191

J3404



1+

0 m

2

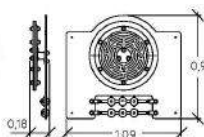

Installed on G3422/G3425 posts

Maze Panel

J3404

£1 561

J3405



1+

0 m

2

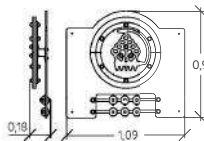

Installed on G3422/G3425 posts

Flipper Panel

J3405

£1 589

Compact composite panels

Stainless steel

Painted metal posts

PLAY PANELS, AUDIO & MUSICAL PLAY

EDUCATIONAL & SENSOY EQUIPMENT

J3403



1+



0 m



3



Trombino Play Table

J3403A

£781

J3403B

£828

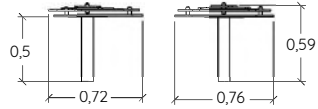

J3423®



1+

0 m

2



Clock Panel

J3423

£977

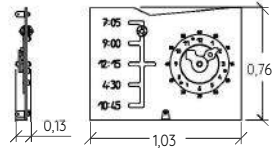

Installed on G3425 posts

J3422®



1+

0 m

2



Dice Games Panel

J3422

£1 625

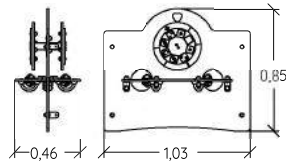

Installed on G3424 posts

J3424®



1+

0 m

1

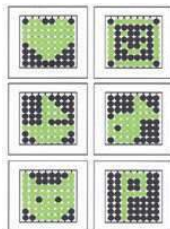

Abacus Panel

J3424

£1 707

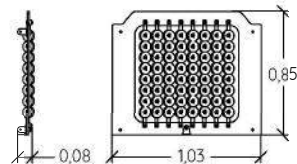

Installed on G3425 posts

Examples

J3419



2 +

0 m

2

Insect Panel

J3419

£2 718

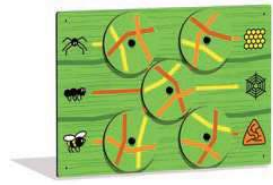

Installed on G3422/G3425 posts

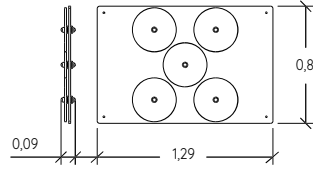

J3420



3 +

0 m

2

Geometry Panel

J3420

£2 871

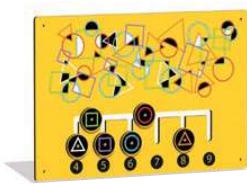

Installed on G3422/G3425 posts

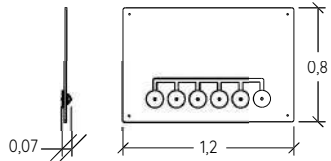

R34-FITICTAC3



2 +

0 m

2

Tic Tac Toe Panel

R34-FITICTAC3

£785



Installed on G3422/G3425 posts

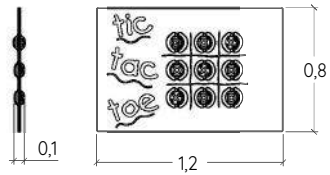

R34-FIROW3



2 +

0 m

2

Four in a Row

R34-FIROW3

£976

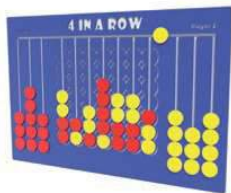

Installed on G3422/G3425 posts

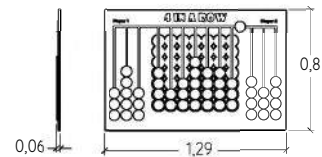

PLAY PANELS, AUDIO & MUSICAL PLAY

EDUCATIONAL & SENSORY EQUIPMENT

J3425®



1+

0 m

2



Orchestra Panel

J3425

£1 639

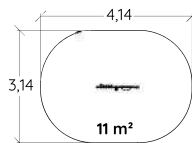
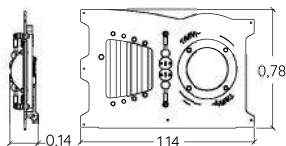

J3418



1+

0 m

3



Sensory Flowers

J3418A

£3 755

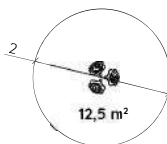
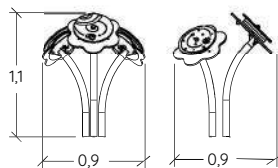
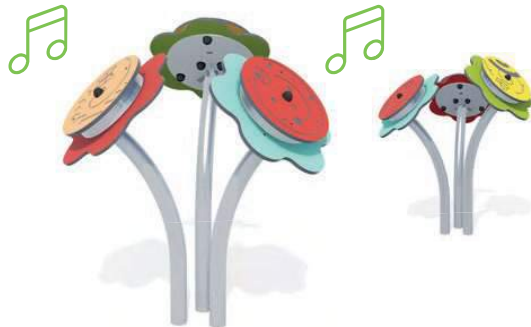

J3410



2+

0 m

2

Tubophone

J3410A

£1 418

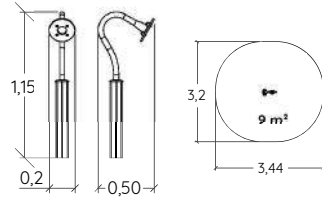

R34-FIMUBON6



2+

0 m

2

Tam Tam Bongos Panel

R34-FIMUBON6

£1 273



Installed on
G3422/G3425 posts

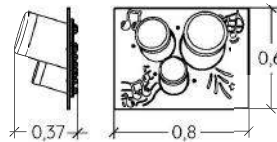

R34-FIECOCH



2+

0 m

2

Xylophone

R34-FIECOCH-A

£1 475

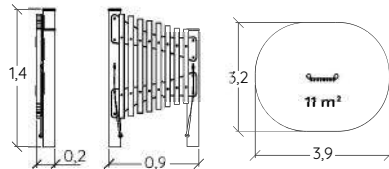

Compact composite panels

Polyethylene

Stainless steel

Painted metal posts



SAND PLAY, WATER PLAY AND GARDENING EDUCATIONAL & SENSORY EQUIPMENT





The handling of water, sand and soil is a great source of sensory experiences. Children enjoy themselves working with these materials whose properties allow a multitude of experiments. They refine control and coordination of hand movements.

They gain awareness of the concepts of shape, state, weight, volume... and learn to understand cause and effect relationships.

Gardening activities also help them understand how they can interact with nature and understand the notion of life growing. In addition, gardening can also help develop children's sense of smell.

SAND PLAY, WATER PLAY AND GARDENING

EDUCATIONAL & SENSORY EQUIPMENT

J120

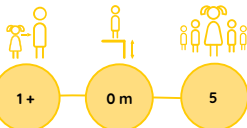

Sand Table

J120A	£339
-------	------

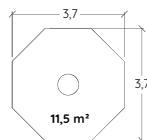
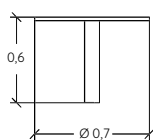

J123



Sand Sieve

J123A	£517
-------	------

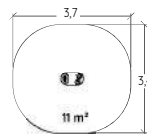
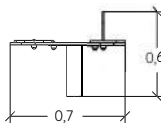
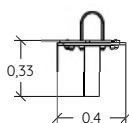

J106



Sandbox

J106A	£552
-------	------

G106	£719
------	------

J106+G106

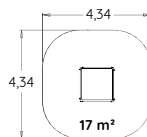
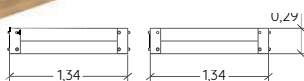

J105

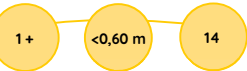

Hexagonal Sandbox

J105A	£2 433
-------	--------

G105	£616
------	------

J105+G105

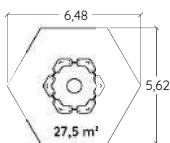

J130

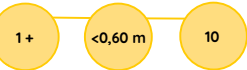

Parasol Sandpit

J130A	£9 090
-------	--------

J130B	£9 090
-------	--------

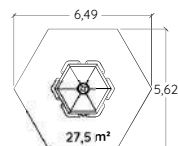
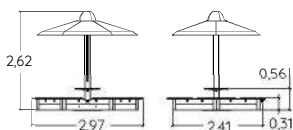

NEW

J5615®

2 +

1,17 m

15

J5615A

£11 918

J5615A-C

£12 619



J5615A



J5615A-C

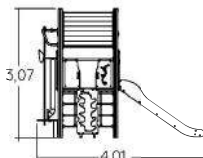
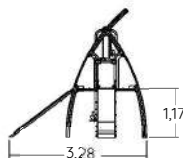
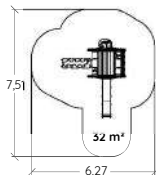

J3890®



2 +

1,37 m

18

J3890A

£15 610

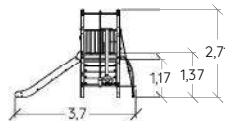
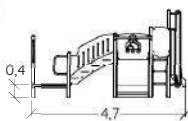
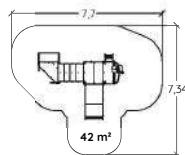

J2671-M

3 +

1,30 m

12

Sahari

J2671A-M

£7 554

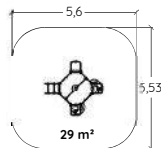
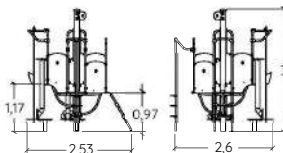

Find out more about the other 11 « Sand play, water play and gardening » products on our website.



Compact composite panels

Stainless steel

Galvanised steel

Timber posts

Painted metal posts

SAND PLAY, WATER PLAY AND GARDENING

EDUCATIONAL & SENSORY EQUIPMENT



J5014

2+

<math><0,60\text{ m}</math>

1

Sand Digger

J5014A

£2 354

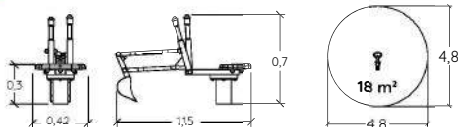

NEW

J5015®



2+

<math><0,60</math>

1

The Inclusive Excavator

J5015A

£2 351

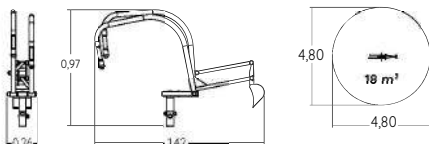

J5000-M

2+

<math><0,60\text{ m}</math>

8

The Sand Factory

J5000A-M

£10 520

J5000A

£9 789

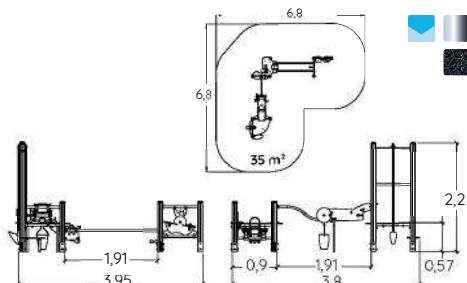

J5001-M

2+

<math><0,60\text{ m}</math>

15

The Sand Factory

J5001A-M

£16 248

J5001A

£14 838

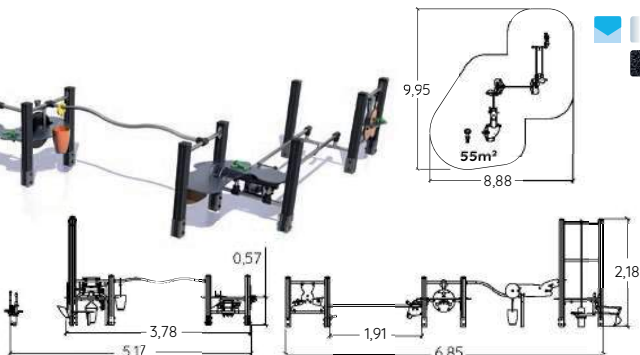

J1716



1+

0 m

22

Washhouse

J1716B	£5 611
--------	--------

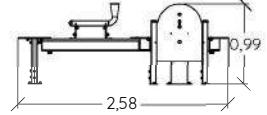
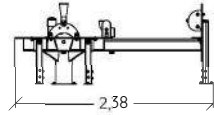
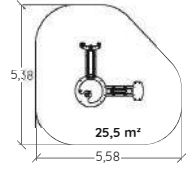

J5300



3+

0 m

10

Gardening Workshop

J5300A	£3 059
J5300B	£3 059



Accessories not supplied

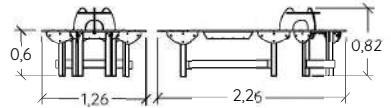
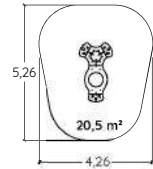

J5301



3+

0 m

14

Gardening Workshop

J5301A	£4 120
J5301B	£4 120



Accessories not supplied

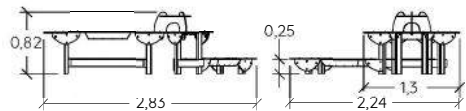
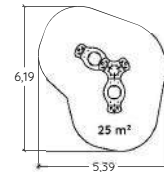

Compact composite panels

Galvanised steel

Timber posts

Painted metal posts



INTERACTIVE PLAY

EDUCATIONAL & SENSORY EQUIPMENT



Interactive play experiences combine physical and intellectual activities and technology. Designed for a connected generation, these play activities interweave sound, light and action. Visual and audio stimuli call upon juniors' cognitive functions, requiring them to use memory, recognition, speed and responsiveness.

Group challenges also help develop team spirit, cooperation and cohesion in children.

J3451-R®



2+

0 m

1

Light-It-Up Challenge

J3451A-R

£5 084

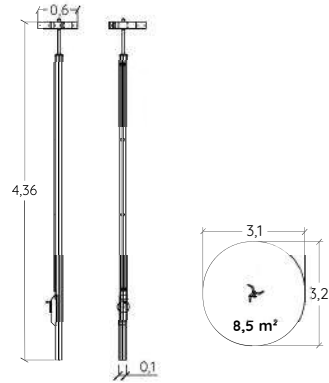

J3450



3+

0 m

2

Interactive Game

J3450A

£19 044

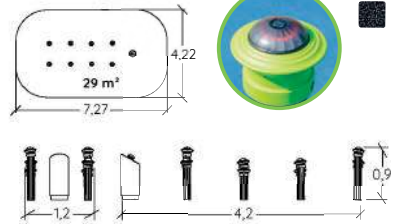
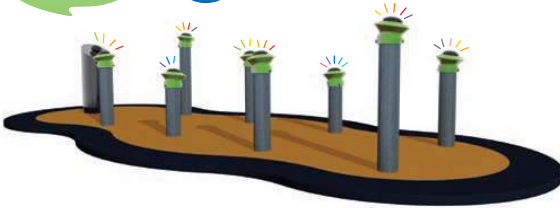

J3511®

6+

0,70 m

3

E-Rollrunner

J3511B

£18 733

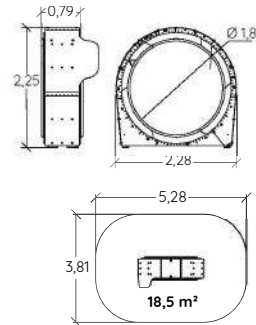
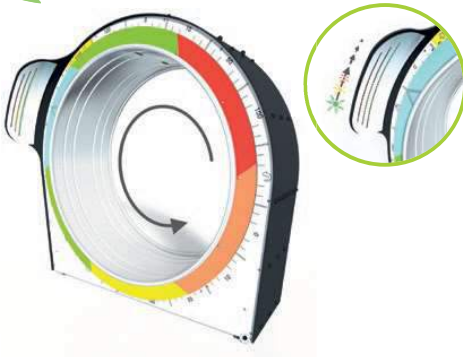

Compact composite panels

Stainless steel

Painted metal posts

Polyethylene

EDUCATIONAL & SENSOY EQUIPMENT





SPORT FOR ALL - ANYTIME, ANYPLACE, ANYWHERE

Proludic's sports & fitness areas are designed to encourage everyone to enjoy and engage in physical exercise, regardless of their age, abilities, level and objectives. Users can exercise independently on a range of sports and fitness equipment to develop their motor skills while maximising fun.

These mixed-gender and inclusive areas cater to every generation and guarantee an enjoyable and productive experience.

CARDIO-TRAINING AREA

1

Trim trails



PLAY AREA

4

Dynamic Structures

Pages: 185-188-189

5

Ropes circuit

Page: 226



6

IXO

Page: 72

7

Trampolines

Page: 234

RELAXATION AND SUPERVISION AREA

10

Tables, benches and bins

Page: 280



RECREATIONAL SPORT AREA



2

ACTI'Ninja
Page: 230



5

Multi-use games areas



2

5

9

FITNESS AREA

8

ACTI'Fit stations and equipment

9

Street Workout



OUR SPORTS & FITNESS RANGES

ACTI'FUN
BY PROLUDIC

Making fitness fun for Everyone



ACTI'FUN app
A sports coach that supports users to exercise just as they want!

ACTI'Ninja
BY PROLUDIC

Obstacle courses for children aged six and above

- ▶ 15 modules available
- ▶ Several difficulty levels
- ▶ Option of adding a coloured, learning-oriented soft surface

Find out more: [page 230](#)



ACTI'Street
BY PROLUDIC

Street Workout combinations for mixed-gender, multi-generational and inclusive use

- ▶ 23 exercise modules available
- ▶ A functional and technical design inspired by a partnership with the World Street Workout and Calisthenics Federation

Check it out in our [Sports & Fitness catalogue](#)



Fully-featured, inclusive combination

ACTI'Fit
BY PROLUDIC

Fitness stations and equipment to encourage physical and sports activity through play

- ▶ Original fitness and sports equipment, including a bubble balance board, punch bag, duo board and curved trampoline
- ▶ 5 combinations available
- ▶ Based on the fitness equipment used in gyms

Check it out in our [Sports & Fitness catalogue](#)



Fully-featured fun-sport station

EXPLANATORY VIDEOS



► Multi-use games areas

Compact structures accommodating several activities in one location, including football, basketball, handball, volleyball and hockey...

- Modular, inclusive, durable and safe
- Areas where teens can socialise and have fun
- 24 options available

► Metal trim trail / Wooden trim trail

A succession of muscle-building, cardio and stretching exercises that can be sequenced together to create a complete and scalable workout

- For those who regularly exercise or simply enjoy walks
- Available in two heights to create trails suited to younger users or adults
- 39 options available



► Dynamic Structures

Equipment designed around extreme sports for thrill-seeking teens

- Rich sports content: heights, speed, slack-lining and rotation
- 8 options available

► Football, table tennis, basketball

Individual items of equipment for creating an additional focal point in a sports area

- All users
- 6 options available

► Off-road cycling trails

Modules that can be combined to create circular or straight-line circuits depending on the terrain

- For casual cyclists or competition riders, whether solo or in groups
- 8 options available



Check out our complete range of sports and fitness equipment



On our website at proludic.com



In our Sports catalogue 2023
(available in the spring)

In the ACTIFUN brochure
Making fitness fun for Everyone





FURNITURE & SIGNAGE

Furniture 282
Signage 286

Leisure spaces are places to relax for all age groups, users and accompanying adults, and successful design is achieved through the harmony created between play equipment, furniture and the environment.

Designing a play area, therefore, involves much more thought than just play aspects. Allowing children the freedom to play in a clean, hazard-free location protected from paths and roads is paramount. However, providing parents, carers and users the ability to rest, have a snack and chat also contribute to a successful leisure space.

Classic or contemporary in design, we have furniture suitable for every project setting, which will blend into any environment seamlessly.

Our signs are practical, aesthetic and fun, providing useful information for play area users. Text can vary depending on where the signs are installed.

J608

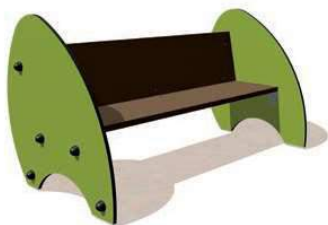

Children's Seat

J608A £483

J608B £434

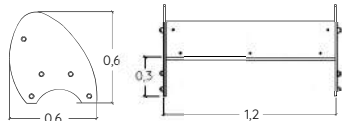

J607



Children's Play Seat

J607A £757

J607B £708

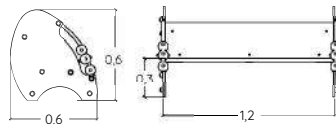

RBA1



Valloire Park Seat

RBA1 £700

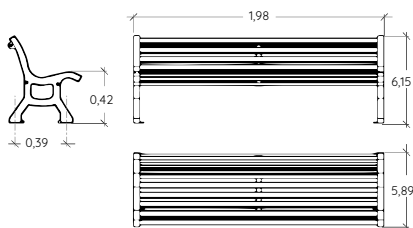

RBA8



Chaumont Park Seat

RBA8 £716

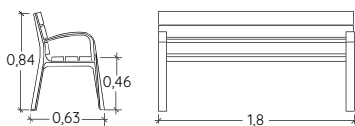

J605



Play Table

J605A

£742

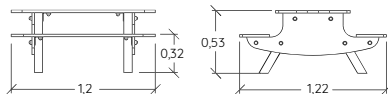

J2880



Picnic Table

J2880A

£1128

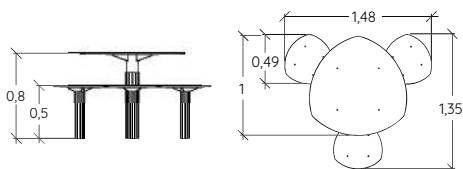

J2870

Bench

J2870B

£789

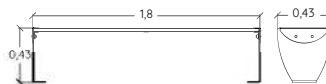

J2871



Seat

J2871B

£1 324

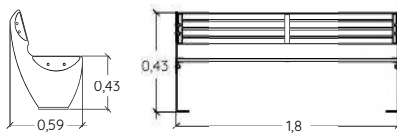

Compact composite panels



Polyester slats



Painted metal posts



Timber slats



Plywood

J2230



J2230A £444

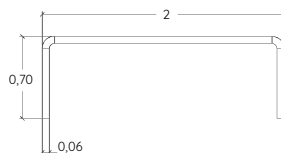

J2825



Sit & Lean Bars

J2825A £1172

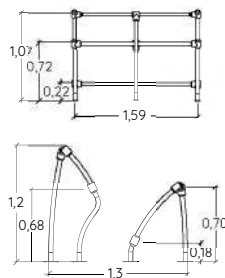

J2850



Meeting Point

J2850A £8 227

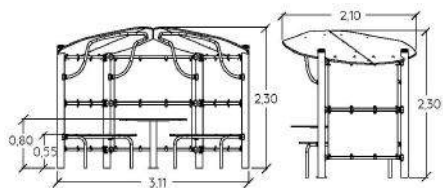

RC01



Litter Bin

RC01

£230

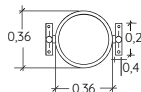
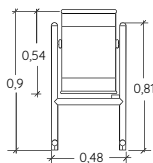

RC03



Litter Bin

RC03

£395

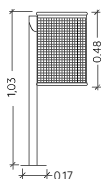

J2821



Mono Bin

J2821B

£1 070

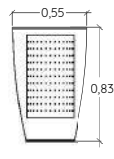
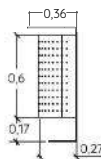

J2822



Duo Bin

J2822B

£1 229

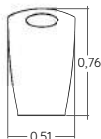
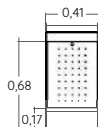

Find out more about the other 10 « Furniture » products on our website.



Compact composite panels

Stainless steel

Galvanised steel

Painted metal posts

Painted Aluminium

GS2405

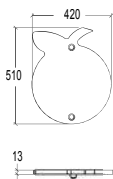

Custom engravings

GS2423-S

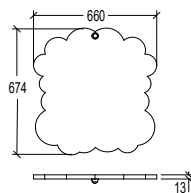

GS2405	£253
GS2423-S	£359

GS2420



Custom printings

EXAMPLES OF DESIGN



Custom engravings

GS2410	£189
GS2420	£314

Colours depending on stock

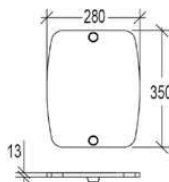

GS2430



Laminated wood post
95 x 95 mm

GS2431



Metal post
95 x 95 mm

GS2432

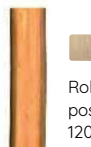

Robinia post
120 <math>< \varnothing </math> 140 mm

GS2430A	£134
GS2431A	£200
GS2432A	£110

GS2433



GS2433	£53
--------	-----

Panel fixings (the pair)

J2883

J2883A

£1 901



Other example on 1100x905mm panel (available on quotation)

Custom printings



GS2440

GS2440

£53



Custom printings



 Compact composite panels

 Robinia

 Painted metal posts

 Timber posts

 Aluminum composite panels (Dibond)



TECHNICAL SERVICES

Choice of materials 289

Index 294

Our guarantees 296



Compact composite

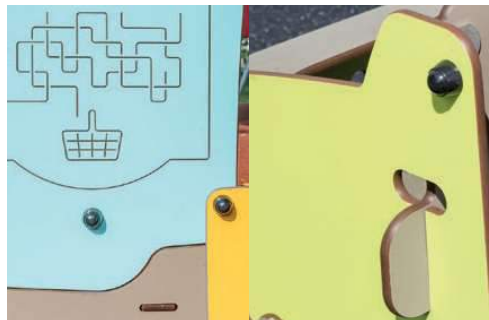

Our compact composite panels are 13mm thick, and they are made up of softwood fibre (70%) and phenolic binder (30%). They show high levels of dimensional stability over long periods.

The material is unaffected by exposure to major temperature variations, guaranteeing the durability and solidity of the assembled elements. It is a versatile material that is not affected by contact with damp or abrasion.

The coloured surfaces are obtained using pigmented resins that provide good levels of resistance to ultraviolet radiation and aggressive cleaning products.



A range of colours has been specially developed by Proludic, enabling the company to highlight the originality of the equipment and its play aspects.



The platforms are made from a textured and non-slip compact material (HPL), 12,5mm thick.

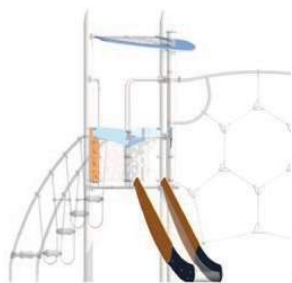

Plywood



Plywood is made from thin sheets of wood that are bonded together, crossing the layers to counteract the wood's natural movements and produce a **rigid and durable product**.

Birch is used for our 21mm plywood panels due to the quality and strength it provides.

Plywood is stable against moisture and therefore ideal for outdoor use in varied climates.

The colours enhance the aesthetic appeal and are applied by electrostatic spraying of two-component polyurethane lacquer that is free of heavy metals. It is **resistant to potentially aggressive chemicals such as anti-graffiti cleaning products**. The polyurethane lacquer also protects the plywood **from damage by ultraviolet radiation**.



Robinia



Robinia is a broad-leaved species renowned for **its natural longevity and resistance** to external attacks (insects, fungi, inclement weather, etc.) without any fungicide or insecticide treatment.

This wood has been adopted by the construction industry for **its natural resistance to rot** and is perfectly suited to use as posts offering heavy load-bearing capabilities. After removing the bark, the trunks are used as is without any machining or treatment.

Splinter-free and never too hot, even after prolonged exposure to the sun, **Robinia guarantees maximum safety**.

Since Robinia is a living material, natural phenomena (greying due to UV light, cracks, etc.) can appear over time, which may alter the initial appearance of the product but without any impact on its intrinsic structural quality.



Laminated wood



Laminated wood is made up of layers of solid wood (often Fir or Scots pine) glued together. **It is a very strong material and ideal for posts that have to carry larger loads.**

Its qualities of resistance to dampness and pollution **reduce the maintenance costs of the structures and ensure their durability**.

Durability is further enhanced thanks to:

- Autoclave treatment of the laminated wood that provides in-depth protection from fungi, insects and termites.
- A surface coating that makes the wood waterproof and protects it from UV radiation.

The timber is free of defects (knots or splits) because they are identified and removed during the cutting work on the laminated strips. It is also **free of splinters**, which eliminates the risk of injury and is pleasant to touch.





Our galvanised steel and painted galvanised steel posts

Our metal posts are made of 2.5mm thick galvanised steel to ensure the requirements for **robustness and safety of play structures are achieved**.

The posts provide a **guarantee of longevity** under widely varying climatic conditions thanks to the steel galvanisation process. The application of a **polyester powder coating that is resistant to UV radiation and temperature variations provides further protection**.

Proludic has developed its own unique galvanised steel posts. Their round shape and fluted aspect form an effective anti-graffiti surface. The two-toned grain finish reduces the appearance of scratches and ensures the aesthetic integrity of the posts.



Our stainless steel tubes

Stainless steel is a material with **high mechanical strength**.

Our stainless steel tubes stand up to graffiti, bad weather and urban pollution; **they require very little maintenance and are also resistant to even the most aggressive solvents**.

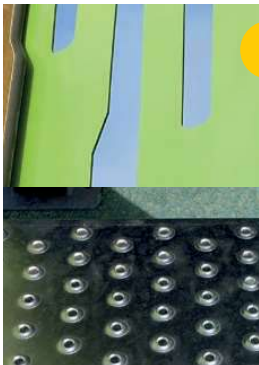

Our painted aluminium panels

Aluminium is **durable and strong**, making it suitable for many applications. The natural formation of a surface oxide layer enhances its **resistance to corrosion**.

Application on aluminium of a **coat of polyester epoxy paint** provides high levels of resistance to UV radiation and temperature variations, **ensuring long equipment life in diverse environments**.

Our plastic parts

Proludic selects the various types of plastic based on their properties and intended purpose.

Our plastic parts are non-toxic and resistant to wear, impact, climatic variations and many chemicals. They ensure durability and long life of our play equipment.

All our plastic parts are marked with standard international abbreviations, which ensure their **traceability** and **recycling credentials**.



Our ropes

Our ropes are made of corrosion-resistant galvanised steel wire cable strands covered with polyester. **The multi-stranded wire cables remain flexible whilst resisting distortion and withstand heavy loads.**

The strong and durable polyester covering ensures **user comfort and protection.**



Our fixings

Our fixings are made of stainless steel to **ensure the excellent robustness of our assemblies and resistance to wear, corrosion and climatic variations.**

All fixing components are protected by anti-vandal polyamide caps.

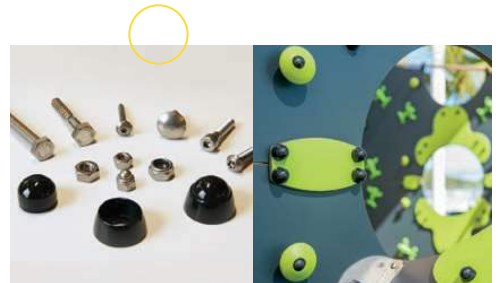

OUR MECHANICAL SYSTEMS

Our experience has shown that our products are subjected to extreme stress.

This has led us to develop specific parts to guarantee an optimum level of comfort, durability and strength.

HERE ARE SOME EXAMPLES:



The in-house systems we have developed ensure the reliability of our products while preventing wear, distortion and breakage of mechanical parts.

Springers

The support bracket is an exclusive part patented by Proludic. Made from filled polyamide, it provides exceptional resistance, safety and durability to the system whilst being aesthetically pleasing.



Swings

The seat mounting brackets are designed to withstand heavy loads. They are made from stainless steel wire and are gently rounded in shape to ensure user safety.

PVC sliding rings limit wear to metal parts caused by swinging movements over time, and extend the product life.

Rotation systems



The components used in our rotation systems are selected for their mechanical qualities and guarantee the reliability and robustness of the equipment.

Encased or inserted into connecting parts, our rotation systems are both waterproof and aesthetic.

INDEX

G1											
G105	268	J1608-M	247	J2541-M	74	J2693	112	J3510*	185	J3837	29
G106	268	J1610-M	247	J256	200	J2694	112	J3511*	185	J3837-C	29
G3		J1661	246	J2578	78	J2695	112	J3512*	114	J38402	130
G3421	260	J1661-M	246	J2578-M	78	J2696*	127	J3601	100	J38403	131
G3422	260	J1662-M	246	J2579	79	J2750-M	124	J3602	100	J38404	131
G3423	260	J1716	271	J2579-M	79	J2751-M	124	J3603	188	J3845	31
G3424	260	J1956	123	J2580	77	J2755-M	124	J3800-M	246	J3845-C	31
G3424	260	J1958	123	J2580-M	77	J2770	95	J38102	36	J38452	131
G3425	260	J1959	123	J2581	192	J2771	95	J38102-C	36	J3850	28
G3426	260	J1961	126	J2581-M	192	J2821	285	J38107	37	J3850-C	28
GS		J1962*	125	J2582	192	J2822	285	J38107-C	37	J38501	90
GS2405	286	J2		J2582-M	192	J2825	284	J38109	37	J38502	90
GS2410	286	J220*	202	J2583	77	J2850	284	J38109-C	37	J38503	91
GS2420	286	J2230	284	J2583-M	77	J2870	283	J38118	33	J38504	90
GS2423-S	286	J223*	202	J2584	81	J2871	283	J38118-C	33	J3851	31
GS2430	286	J225*	203	J2584-M	81	J2880	283	J38119	32	J3851-C	31
GS2431	286	J232*	202	J2586	76	J2883	287	J38119-C	32	J38550	92
GS2432	286	J234*	203	J2586-M	76	J3		J38122	34	J38551	92
GS2433	286	J235*	201	J2587	80	J3301	66	J38122-C	34	J38552	92
GS2440	287	J236*	201	J2587-M	80	J3302	66	J38124	30	J38553*	91
JO		J237*	201	J2591	188	J3311	67	J38124-C	30	J38603	109
J09	257	J238*	201	J2603	110	J3338	66	J38125	30	J38604	109
J1		J239*	201	J2604	122	J3358	67	J38125-C	30	J3862	33
J10	257	J2400	184	J2605	130	J3359	67	J38126	30	J3862-C	33
J1010	220	J2401	186	J2611*	110	J3401	260	J38126-C	30	J3866	35
J1011	221	J2403	184	J2612	110	J3402	260	J38127	32	J3866-C	35
J1011-GA	221	J2404	184	J2613	88	J3403	262	J38127-C	32	J3867	35
J1012-P*	220	J2406	187	J2614	88	J3404	261	J38128	29	J3867-C	35
J1012*	220	J2407	187	J2616	111	J3405	261	J38128-C	29	J3870	36
J105	268	J2409	186	J2617	111	J3406	260	J38129	32	J3870-C	36
J1056	221	J2410	189	J2618	111	J3407	260	J38129-C	32	J38700-C*	220
J1057	221	J2411*	184	J2619	111	J3410	265	J38131*	37	J38700*	220
J106	268	J2523	81	J2623*	88	J3411	261	J38200	33	J38701-C*	24
J1069-P*	220	J2523-M	81	J2624*	89	J3412	261	J38200-C	33	J38701*	24
J1069*	220	J2532	79	J2625*	89	J3413	261	J38201-C*	34	J38702-C*	25
J110	222	J2532-M	79	J2626*	89	J3417	261	J38201*	34	J38702*	25
J1120	222	J2533	75	J2633-M	86	J3418	264	J38203-C*	28	J38703-C*	26
J1121	222	J2533-M	75	J2636-M	86	J3419	263	J38203*	28	J38703*	26
J1122	222	J2534	74	J2646-M	122	J3420	263	J38301	102	J38705-C*	26
J1123	222	J2534-M	74	J2656-M	130	J3422*	262	J38303	102	J38705*	26
J1124	222	J2535	80	J2671-M	269	J3423*	262	J38304	102	J38706-C*	24
J1130	222	J2535-M	80	J2683*	93	J3424*	262	J3832	36	J38706*	24
J12	257	J2536	76	J2684	115	J3425*	264	J3832-C	36	J38707-C*	25
J120	268	J2536-M	76	J2685	114	J3426*	147	J3833	35	J38707*	25
J123	268	J2537	75	J2687	93	J3450	273	J3833-C	35	J38708-C*	26
J13	257	J2537-M	75	J2688*	94	J3451-R*	273	J3834	34	J38708*	26
J130	268	J2538	78	J2689*	116	J3501	188	J3834-C	34	J38709-C*	24
J14	257	J2538-M	78	J2690	117	J3503	248	J3835	29	J38709*	24
J16	257	J254	200	J2691	113	J3504-N	189	J3835-C	29	J38711-C*	25
J1605-M	247	J2541	74	J2692	112	J3505	189	J38352	103	J38711*	25



J3872	28	J473	210	J4930	138	J5401-M	228	J57008	241	J856	170
J3872-C	28	J47450	103	J4930-V	138	J5402	228	J57009	46	J857	172
J3874-C*	31	J476	210	J49302*	149	J5402-M	228	J57009-C*	46	J858	175
J3874*	31	J4800	242	J4931	139	J5403	229	J57011*	240	J859	177
J3890*	269	J4801	243	J4932	139	J5403-M	229	J57012	48	J864	171
J3960	208	J4807	239	J4932-V	139	J5406-M	228	J57012-C*	48	J866	170
J3961*	170	J4811	239	J4933	138	J5407	229	J5901*	233	J867	171
J4		J4815	240	J4933-V	138	J5407-M	229	J5902*	231	J869*	171
J4010*	221	J482	215	J4934	141	J5408	229	J5903*	231	J870*	173
J4020	108	J483	215	J4937	140	J5408-M	229	J5904*	232	J880	154
J4021	87	J48304	249	J4937-V	140	J56002*	53	J5905*	231	J881	154
J4022	101	J48305	249	J4938	139	J56003-GA*	52	J5906*	232	J882*	154
J4031*	86	J484	211	J4939	140	J56004*	52	J5907*	231	J9	
J4039	115	J487	212	J4939-V	140	J56005*	53	J5908*	233	J951*	177
J4050	108	J489*	152	J4940	138	J5602	42	J5909*	232	J952*	178
J4051	86	J490	152	J49411*	142	J5602-C*	42	J5910*	232	J981	177
J4052	100	J4900	159	J49417*	143	J5603	43	J5911*	232	J984	177
J4060	108	J4901	158	J4945	161	J5603-C*	43	J5912*	231	J985	176
J4061	87	J4902	159	J4946	161	J5604	43	J5913*	232	J986	175
J4062	100	J4903	158	J4947	141	J5604-C*	43	J5914*	231	J987*	179
J4080	109	J4904	158	J4947-V	141	J5605	42	J5915*	233	R2	
J4081	87	J4905	159	J4949*	146	J5605-C*	42	J6		R24-ITY-724	189
J4092	101	J4906	158	J4950*	146	J5606	45	J60001*	238	R3	
J410	248	J4907	158	J4951*	146	J5606-C*	45	J605	283	R34-ETP-000	235
J415	248	J4908	158	J4952*	146	J5608	45	J607	282	R34-ETP-004	235
J432-C*	211	J4909	160	J4955*	146	J5608-C*	45	J608	282	R34-ETP-010	235
J432*	211	J491	153	J4958*	146	J5609	46	J8		R34-ETP-500	235
J433-C*	211	J4910	160	J496	213	J5609-C*	46	J802	173	R34-FIECOCH	265
J433*	211	J49100*	147	J498	152	J5610	44	J818	173	R34-FIMUBON6	265
J435-C*	212	J49101*	148	J499	153	J5610-C*	44	J819	174	R34-FIROW3	263
J435*	212	J49102*	148	J5		J56100	56	J820	174	R34-FITICTAC3	263
J438	210	J49103*	149	J5000-M	270	J56101	58	J821	174	R4	
J440	208	J49104*	148	J5001-M	270	J56102	60	J822	175	R48-IPY-702	240
J441	212	J49105*	155	J5014	270	J56103	59	J826	176	R49-IPY-1611	214
J442-M	214	J49107*	148	J5015	270	J56104	57	J827	175	RB	
J443*	209	J4911	160	J510	193	J56105	60	J828	173	RBA1	282
J444*	213	J4912	160	J51000*	256	J5611	49	J830	177	RBA8	282
J445*	209	J49125*	163	J51001*	256	J5611-C*	49	J833	171	RC	
J450	208	J4913	159	J511	193	J5612	47	J834*	170	RC01	285
J45202	70	J49142*	155	J512	193	J5612-C*	47	J835*	174	RC03	285
J45206	71	J49143*	163	J513	195	J5613	47	J836	171		
J45416	70	J49144*	163	J514	193	J5613-C*	47	J837	170		
J45417	71	J49145-V*	149	J515	192	J5614	43	J838	174		
J468	208	J49146*	147	J516	194	J5614-C*	43	J839	176		
J4701	132	J4914*	163	J517	195	J5615-C*	42	J842	175		
J4701-P	132	J49156	162	J520	194	J5615*	42	J844	175		
J47101	104	J49157	162	J5300	271	J5616-C*	44	J846	176		
J47101-P	104	J49160	162	J5301	271	J5616*	44	J853	176		
J472	210	J4920	154	J5400	228	J57003	241	J854	172		
J47251*	125	J493	213	J5400-M	228	J57006	240	J855	172		



Guarantees

25, 10, 5 and 2 years

Proludic is committed to the quality and durability of its products.

In addition to using carefully selected materials and applying the highest manufacturing standards, Proludic provides extensive guarantees.

Our guarantees:

25 years for any structural failure of sport or play products due to a material or manufacturing failure of:

- Panels (lacquered plywood / coloured compact / polyethylene)
- Posts and supporting structures (painted galvanised steel, galvanised steel, stainless steel)
- Stainless steel tubes

10 years for any structural failure of sport or play products due to a material or manufacturing failure of:

- Metal components (with the exception of springs, moving or mechanical parts and fixings)
- High density plastic parts (with the exception of moving or mechanical parts)
- Non-slip plywood and compact panels
- Posts (timber)
- Robinia wood planks

5 years for any structural failure of sport or play products due to a material or manufacturing failure of:

- Springs and mechanical systems
- Moulded or rotary moulded plastic parts (with the exception of moving parts)
- Metal crimps and rope assemblies

2 years for any defect or manufacturing fault of component parts.

The colours reproduced in this brochure may not be true to life, Proludic reserves the right to change specifications and make product improvements to any of our products at any time without notice. Information in this brochure was correct at the time of printing. While every effort has been made to ensure the accuracy of information, Proludic cannot accept any responsibility for any errors or omissions and this brochure does not form part of any contract.

Photo credit: Proludic & Fotosearch



Key Terms and Conditions

Correct at the time of printing. Our full terms and conditions are available on request and are subject to change at any time.

Formation of a Contract

The quotation given on or attached to these terms and conditions will remain valid for a period of 90 days, unless otherwise stated on the quote. Acknowledgment and acceptance of this proposal is made by you placing an order within the specified period above, at which time you will be bound by these terms and conditions. Each proposal accepted shall constitute an individual legally binding contract between you and us. Such contract is hereinafter referred to in these terms and conditions as «an order».

Nothing in these terms and conditions shall prejudice any condition or warranty expressed or implied, or any legal remedy to which we may be entitled in relation to the goods / and or the work the subject of this order.

Our Responsibility

We will ensure that all materials supplied comply with safe building practices and are free from defects and that any work carried out is carried out with reasonable care and skill and to a reasonable standard. Before starting any work we will carry out an inspection to make sure that all work quoted is appropriate and practicable.

If after our inspection any further work is necessary either because of alterations in design, specification or otherwise and this causes an increase in costs we will send you a further proposal giving details of the extra costs and will only proceed with the works once your written acceptance has been received.

Subject to our terms we will carry out the work in accordance with our proposal.

We will make good any damage caused whilst carrying out the work.

Your Responsibility

You will permit us during normal working hours to carry out an inspection and thereafter to undertake the works according to the programme set out in the proposal.

You will remove all items necessary to allow us to commence the works and cover and protect all fixtures and fittings, (which cannot be removed. You will obtain all permissions and consents, (including if necessary planning permission) from landlords, local authorities and others, which are required before the work can commence.

Where you are required to provide us with measurements or other information such measurements or information must be correct. If we rely on the measurements or information given when preparing our proposal and such measurements or information are incorrect we reserve the right to increase the price to make good any errors or additional works required as a result.

Payment

Goods are invoiced upon dispatch. Payment terms are strictly net 30 days from the date of invoice. Acceptance of this order constitutes agreement of these terms and overrides any other payment terms, including any quoted on your purchase order. We reserve the right to issue interim invoices or applications for payment, or request payment prior delivery or installation on a proforma basis.

Please note all prices quoted are excluding VAT.

Delivery/Installation Dates

UK delivery is priced at 10% (with a minimum £100 charge) based on the total list price value of the equipment. We reserve the right to increase the delivery charge dependent on location of delivery address, all amended prices will be notified on quotations.

You will be provided with an estimated delivery date on receipt of order and updated throughout the order process. Delivery is approximately 6-8 weeks from the date of order. Deliveries that cannot be accepted by the customer within 2 weeks of the agreed date, will be subject to a storage charge of £100 per week or 1% of the equipment value, whichever is greater.

Minimum Installation Charge

On orders received with installation, a minimum installation charge per site of £1000 applies in all cases.

Budget costs assume that easy lorry access & precise siting of the equipment will be provided, no surface or underground obstructions will be encountered during excavation such as concrete, hard-core, rock, chalk, roots, drainage, gas or water pipes, telephone or electricity cables etc. In the event of any such obstructions we reserve the right to charge for any additional work involved. We cannot accept liability for any consequent charges that may be incurred by disruption of any of the foregoing services. For fixed installation prices, a site survey is required by a company representative prior to the order being placed.

Main Contractor's Discount

Our quotation does not include for a Main Contractor's Discount. If a 2.5% Main Contractor's Discount is applicable, please add 2.563% to our quoted prices.

Cancellation Policy

The company reserves the right to levy a cancellation charge of:

- 25% of the total order value if cancelled more than 10 weeks from the scheduled delivery / start date.

-50% of the total order value if cancelled less than 10 weeks from the scheduled delivery / start date

Please Note: Any such charge is non-negotiable and is solely at the discretion of the Company. All drawings, descriptive and forwarding specifications, particulars of weights and dimensions are approximate only and not binding and illustrations contained in catalogues, price lists, sales literature and other advertisement material are for the purpose of general description only and none of these shall form part of this Contract.

The Play Hub, Bradmore Business Park, Loughborough Road, Nottingham NG11 6QA



PROLUDIC LTD
The Play Hub
Bradmore Business Park
Loughborough Road
Bunny, Nottinghamshire
NG11 6QA
Tel. 01159 823 980
E-Mail: info@proludic.co.uk
proludic.co.uk