



Designer of play and sports areas



ACTI'FUN
BY PROLUDIC



**Making recreational sports
for Everyone**



Proludic, an entire team at your service



The staff at Proludic have extensive experience in the play, outdoor gym and sports area industry. As a Proludic client, you will be able to access a dedicated project team, which includes your own assigned Area Manager, Customer Service Advisor and skilled Designer or Landscape Architect.

This combined knowledge and expertise ensure you receive the highest level of customer care, from the initial planning stage right through to project completion.

Proludic supports you from start to finish, and beyond! From the first steps of raising funds and developing your vision, we define the project specifications and manage the planning process with consideration of all details.

These include site evaluations, equipment suitability and landscape integration. All aspects of the project design and delivery are looked at to provide you with the best outcome for your area. The final proposal will have supporting 2D plans and 3D visuals so you can truly see your vision come to life.

We also offer a comprehensive Aftersales & Maintenance team who are on hand with service cover for the lifetime of your play and sports area.

Contact your local Area Manager
directly from our website:
www.proludic.co.uk/contact-us/



We are active members of the API (Association of Play Industries) and are accredited by both Constructionline and CHAS (The Contractors Health and Safety Assessment Scheme). All our products are independently tested and certified to European Play Standard EN1176 and EN16630 for outdoor fitness equipment. Proludic is also CPD (Continuing Professional Development) accredited.





**Advice and design
planning**



**Project design
and graphic
illustration**



**Project management
and installation**



**Acceptance of work
completed**



**Aftersales
support**



**Maintenance
and servicing**



THE COMPANY	p. 2
Our mission, our values	p. 2
Integrated expert knowledge	p. 4
PLAY TO EXERCISE AND FEEL GOOD	p. 6
ACTI'FUN, MAKING RECREATIONAL SPORTS FOR EVERYONE	p. 8
A concept designed with the experts from the Proludic Observatory	p. 9
Fun sports ranges for everyone!	p. 10
An app to boost sporting activities and fun	p. 12
Activity and motivation indicators	p. 13
ACTI'Fit	p. 16
ACTI'Street	p. 32
ACTI'Ninja	p. 46
MULTI-USE GAMES AREAS	p. 60
Ball games	p. 70
DYNAMIC STRUCTURES	p. 72
TRAMPOLINES	p. 82
SURFACE PATTERNS	p. 86
EXAMPLES OF ACTI'FUN LAYOUTS	p. 88
INDEX / MATERIALS / GUARANTEES	p. 94

LEGEND



Age groups



Free fall height



Number of users



Video available by scanning the QR Code



New in 2023

Inclusion level

The stated inclusion level determines how accessible our equipment is to a user with motor impairments.



At least 1 activity accessible



Fully accessible equipment, or with at least 3 accessible activities

For 35 years, Proludic has been designing, manufacturing and installing playgrounds and sports areas around the world

► Our mission

True to our values, we are focused on our mission of creating playgrounds and sports areas where users can thrive, develop their skills and improve their wellbeing.

We design, manufacture and install products and fun-sports spaces offering the highest quality and safety. Our universal, innovative and inclusive solutions are tailored to meet the wide range of needs among children, teenagers and adults.

We also strive to transform play areas into social hubs that promote and enhance community life.



Award-winning designs



Janus
de l'industrie



Janus
du service



Janus
de la cité



Recognised quality



Endorsed compliance with standards



A certified environmental approach



► Our values

Experience

Proludic draws on the operational expertise it has developed since 1988 to provide customers with superior support and guidance in developing and implementing their projects.

Innovation

Proludic harnesses its collective driving force to extend and upgrade its product range to reflect the changing needs of today's generations and tomorrow's world.

Learn more in our corporate video.

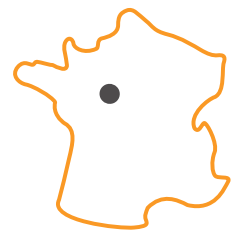

Our head office and manufacturing facility are based in Vouvray, France.

Commitment

All our employees share the company's determination to promote individual fulfilment and wellbeing while enhancing customer satisfaction.

Proximity

All around the world, local teams are ready to respond and bring a dedicated and professional approach to each playground and sports area project.



► International presence

6 subsidiaries

55 countries

340 employees

+100 000 playgrounds and sports areas





▶ Integrated expert knowledge

Design: inextricably interwoven into Proludic's DNA

Proludic's in-house Research & Development Department is a powerhouse for pioneering innovative ideas that comply with applicable standards.

Our designers are responsible for masterminding leading-edge concepts and product ranges geared towards the expectations of all generations. They also have a long track record in developing bespoke and personalised projects.

- ▶ 6 designers and 15 technical engineers.



Integrated manufacturing processes

To better deliver superior efficiency, flexibility and quality, Proludic's manufacturing and distribution functions are based out of the company's head office.

- ▶ 60 qualified workers.
- ▶ Ability to work with a wide variety of materials, including wood, metal, rope, composites and plastics.
- ▶ Quality control and testing on materials and equipment.

Production processes are controlled and managed entirely within the company, meaning that Proludic can manufacture custom products and unique designs with greater responsiveness.



Landscape design

Your project is unique to us!

Each project starts with an initial meeting. This allows us to get to know you as a client and understand your needs, so we can provide a tailor-made design solution in keeping with your brief.

Our combined knowledge and expertise ensure your needs will be carefully assessed, and that we will provide you with advice to ensure consistency across your sports area project in terms of products, location, layout and environment. Following this initial consultation, we are then able to create the most appropriate project design to achieve a harmonious and attractive result.

- ▶ 200 salespeople are in the field every day, across the world.
- ▶ Landscape designers are at your service.



Installation & project management

Proludic project manages each sports project from the time you place your order, through to project completion and beyond.

Our services include:

- ▶ Installation of play and sports equipment
- ▶ Landscape integration
- ▶ General layout works
- ▶ Laying safety surfaces
- ▶ Aftersales service
- ▶ Servicing and maintenance

We carry out all our work in line with the project objectives and follow safety requirements.



Aftersales service

We are here to help, long after your project is installed. If there is anything you need, we will get back to you as quickly as possible.

Our promise to you?

90% of requests are processed within 24 hours

80% of spare parts are shipped within 5 working days

Get in touch!

By phone or via our website

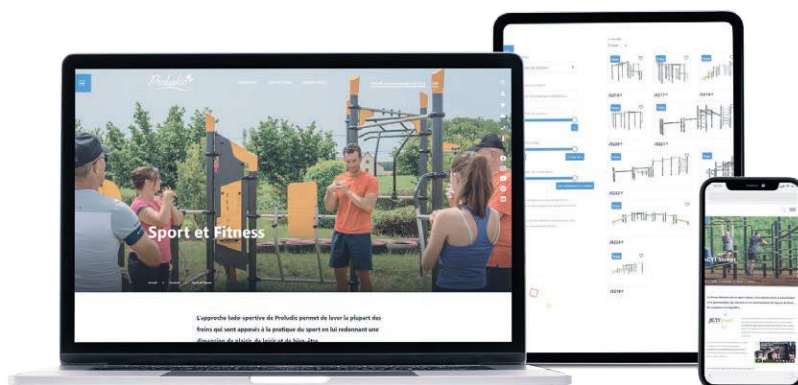

Play to exercise and feel good

Exercise: a habit to be taken seriously to maintain a healthy body and a healthy mind

There are many benefits of undertaking a physical and sporting activity. Every year, many well-documented studies show its positive effects on physical, mental and social wellbeing and further underline the importance of including physical activity in our daily routine throughout our lives.

The benefits of physical and sporting activity...



Strengthens the health of the heart



Boosts energy levels



Improves mental health



Stimulates the brain

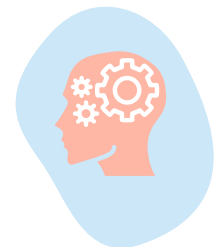

Improves attention / concentration

...all enriched by taking part in **outdoor exercise**



Boosts the immune system



Reduces stress & improves the mood

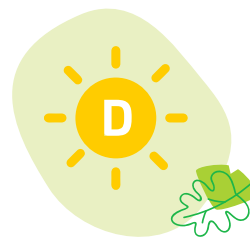

Increases the supply of vitamin D



Improves sleep

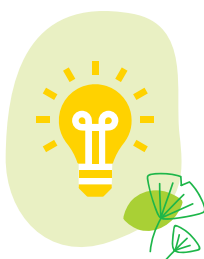

Boosts creativity



Promotes connection with the environment and other people



Is accessible to everyone



Is available free of charge

Despite its acknowledged and well-documented positive effects, the practice of physical and sporting activity still comes up against obstacles

Whether among children, adults, or the elderly, the practice of physical and sports activities still falls short of the WHO (World Health Organisation) recommendations and the consequences this has for health have been proven.



WHO recommendations

- ▶ *Children and teenagers: at least one hour of dynamic physical activity every day.*
- ▶ *Adults and elderly persons: at least 30 minutes of dynamic physical activity every day together with two weekly sessions designed to strengthen muscle strength, flexibility and balance.*

The levels of physical and sporting activity must also be adapted in the light of each individual's gender, age, educational level and socio-professional category.

What are the main obstacles?

I'm **not** in good physical condition

It's **too hard!**

It **hurts!**

I **haven't got time**

It's **not accessible**

It's **(too) expensive!**

I **don't feel like it...**

Eurobarometer March 2018 – INJEP Study 2021



What are the main motivations? Make sport an enjoyable experience!

For several decades, the practice of physical and sporting activities has centred on health, leisure, enjoying the company of others and no longer solely on performance. **Enjoyment** and **wellbeing** have become the key **motivations** to encourage more and more people to take part in sports activities.

Ideally, moving and exercising must not be experienced as an obligation but as **something positive**: we exercise when we want, where we want, at our own pace and in line with what we can achieve, based on rules and aims which we set for ourselves. **The enjoyment of partaking in sports** goes hand-in-hand with this increased search for autonomy.

ACTI'FUN
BY PROLUDIC

Making recreational sports for Everyone

Proludic brings together sport and enjoyment by using play as the connecting element.

Through its **ACTI'FUN** concept, the fun-sports approach is anchored in the company's history and activities namely: play.

Playing is universal, it links together all generations and encourages active lifestyles within a recreational, sharing context.

The playground is one of the most important spaces where children discover the pleasure of moving, while also developing their motor, sensory and relational skills. It is this enjoyment of physical activity that must be encouraged and preserved into adolescence and beyond.



Recreational sports is the right way to anchor movement in everyday routines from a very early age and give everyone the desire to adopt good lifestyle habits in the long term.

Proludic, therefore, offers mixed, inclusive ranges of outdoor play equipment for all ages and all needs: for learning and developing, exercising, challenging oneself, staying in shape, benefiting from nature, or simply relaxing as a family.

From individual wellbeing to general public use, Proludic devotes its expertise to encouraging the practice of physical and sporting activity through play.



A concept designed in collaboration with the experts from the Proludic Observatory

What is the Proludic Observatory?



The Proludic Observatory is a laboratory of ideas and expertise that supports us with the continuous improvement of our play and sports solutions all over the world.

It consists of a network of experts from within and outside Proludic, working in different sectors of the

children's, play and sports markets: play and sports sector professionals, association and educational partners, researchers and health professionals from markets in Europe and Oceania.

These diverse profiles provide a multidisciplinary and multicultural vision, reflecting trends and developments in their market.

ACTI'FUN, a concept and supporting products developed in collaboration with experts from the sports and play sectors

François Coulot

Physical trainer, Dietician (sports nutrition)
Health Coach (France)

Multi-sports athlete: Triathlon and Ironman finisher, athletic strength, volleyball, handball, cycling, judo, windsurfing

Stéphane Degonde

CEO of LudHealth (France)

A specialist in the development of inclusive solutions for active mobility and cognitive, physical and sensory stimulation in living environments and health care facilities.

Nova Child (Innovation Network for Children)



A European network of companies, research laboratories and institutions seeking to promote innovation for the wellbeing of children.

We wish to thank all the various experts who actively contributed to our approach via the Nova CHILD Living Lab mechanism (recognised by the European Network of Living Labs, ENoLL):

▶ Pierrick Thibault

Teacher of adapted physical activities that promote health, with a particular focus on obesity and senior citizens.
Sports instructor for people with intellectual disabilities and children in a badminton club (France).

▶ Tegwen Gadais

Professor and Researcher in the Department of Physical Activity Sciences at the University of Quebec in Montreal (Canada).

His research focuses on the topics of physical education, health education, outdoor physical activities and human development as part of a holistic and complex approach.

▶ Cyril Forestier

Teacher and Researcher at the University of Le Mans (France) and attached to the MIP laboratory (Motricity, Interactions, Performance) based in Nantes (France).

His research focuses on the psychology of physical activities and health with a psycho-cognitive approach.

▶ Bertrand Pulman

Professor of Sociology and Anthropology at Sorbonne Paris Cité (France) and head of a Master's degree in Health, Diseases and Social Issues.

His research focuses on the sociology of the family and the sports-health interface.

▶ Hélène Bordron-Sauvêtre

Psychomotricity therapist working with young children with psychomotor problems, instrumental disorders and behavioural difficulties.

Member of 3 associations of psychomotricity therapists (AFPL, APML and ADPLA).

Fun sports ranges for everyone!



ACTI'Fit[®]
BY PROLUDIC

Fitness stations and equipment



ACTI'Street[®]
BY PROLUDIC

Street Workout configurations



ACTI'Ninja[®]
BY PROLUDIC

Obstacle courses and Trim Trails



**MULTI-USE
GAMES AREAS**

Structures for ball sports



**DYNAMIC
STRUCTURES**

Equipment inspired by extreme sports



TRAMPOLINES

Structures for jumps and moves

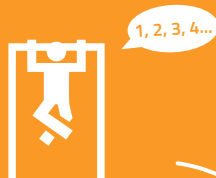

**Intergenerational
Mixed-gender
Inclusive**



We exercise and have fun! with Proludic's fun sports innovations

Balance board

Objective: balance to keep the bubble stable in the centre of the board



It's rocking!

Rodeo board

Objective: create the movement, apply power and control the inevitable lack of balance



Slanted steps

Objective: make your way over the 5 stepping stones as quickly as possible without touching the ground



and right on target!



Shooting target

Objective: display skill and precision to score as many points as possible



Trampoline

Objective: use the 3D bounce surface to perform jumps and acrobatic moves

Smartphone holder

For selfies, videos and to play music with amplified volume



Smile!



An app to boost sporting activities and fun

The **ACTI'FUN app** is a complete solution to support the community with the performance of fun-sports physical activities.

It allows users, whether beginners or experienced athletes, young or old, to easily work out or design their own personalised programme completely independently according to their age, level, physical condition and motivations.

The **interface is free**, easy to use and contains lots of information that can be accessed by scanning the QR codes on the equipment.

For each structure, the user can:

- ▶ Watch videos of the exercises to be performed, including adaptations and difficulty levels to complete
- ▶ View the muscles worked by the exercise
- ▶ Choose sports targets according to his or her user profile
- ▶ Save choices and results in a history
- ▶ Track progress and repeat a session

Designed according to the 'fun sports' concept, this app is also perfect for organising challenges with family or friends.

Who will record the most dips or squats? Who will be the fastest? Who will last the longest on the equipment? All you need to do is start the stopwatch or compare scores on the results pages of the app.



An app designed for everyone!

1 piece of equipment

=

several exercise levels

=

several demonstration videos produced or supervised by sports coaches

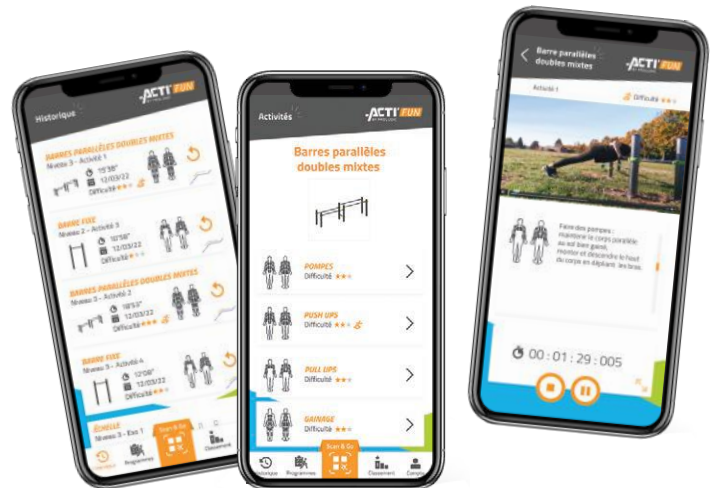

Over to you!



Scan the QR code to download the app!



Simple parallel bars



Inclusive parallel bars



Freestyle bar



Swedish wall



Activity and motivation indicators

In each of its 6 ranges, ACTI'FUN combines play and sports, and proves this through **2 indicators** categorising the physical activity and specific motivation factors for each piece of equipment:

► The sports formula

expresses and compares **four dimensions of sports**: muscle strengthening, heart health, balance and coordination.

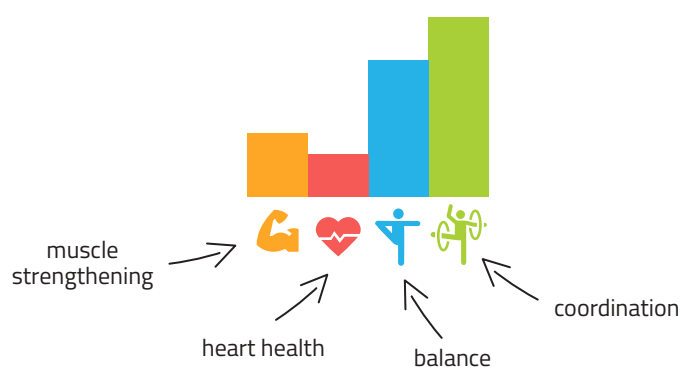

Well done!



► Motivations to enjoy fun-sport

Throughout the ACTI'FUN concept, there are seven fun-sport motivations that **trigger enjoyment** when engaging in physical activity.



ACTI'FUN app

The app allows users to design their own training programme supported by access to videos for all levels and video explanations.



Multimedia

Volume-amplifying smartphone holder, for more atmosphere! Ideal for selfies, streaming videos and playing music.



Sensations

Dynamic situations, hazardous crossings, movements... the equipment promises a whole host of sensations!



Progressive design

Evolving equipment and explanatory video support different levels of difficulty.



Sharing

Activities are practiced in groups, in relays, in a fun atmosphere, with sharing and mutual assistance!



Diversity

The equipment is designed for mixed-use and is complemented by structural elements adapted to different body shapes.



Challenge

Timed challenges, simultaneous circuits, target scores... the sports areas offer lots of challenges!

ACTI'FUN

BY PROLUDIC

It's FUN!

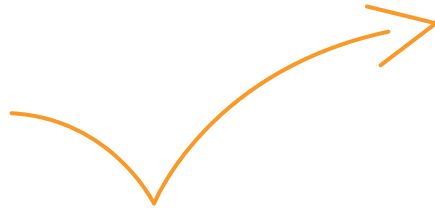

Friendly
interaction
and inclusion





With friends
or family



More
sensations!



Motivations to enjoy fun-sport



ACTI'FUN app: virtual coaching with exercise videos and training programmes.



Volume-amplifying smartphone holder for selfies, playing music, streaming videos, etc.



Innovative, playful fitness activities.



Exercise videos with several difficulty levels available on the ACTI'FUN app.



Compact combinations or groupings of equipment that encourage contact and sharing.



Adaptation and selection of apparatus to encourage contact and mixing.



Challenges through the ACTI'FUN app.



ACTI'Fit[®]

BY PROLUDIC

Proludic fitness equipment consists of a range of items used in sports areas and outdoor gyms for an enjoyable, athletic outdoor experience.



Ergonomically optimised to provide access to all and allowing multiple applications both when exercising and relaxing. This range represents the perfect way to support free, independent outdoor fitness activities whether individually or in groups.

- ▶ The curved trampoline and the balance turntable with its spirit level are genuinely innovative items of fun-sport equipment for use in sports spaces.

- ▶ The structures are arranged around a central column which acts as a clothes storage area, warm-up space and meeting place.
- ▶ The equipment has been designed to support a variety of exercises and progressive improvement in performing each activity.
- ▶ Details of each of the activities can be found by scanning a unique QR code available at each item. Users can target specific muscle groups or strengthen their cardiovascular system.
- ▶ The diversity of the equipment means that there are items suitable for all body shapes.

Fully-featured fun-sport station J37103[®]

A fully-featured station equipped with the maximum possible number of fun-sport activities: grouped abs benches to encourage group exercises, balance board and treadmill to discover new sensations while toning the body, boxing equipment to unwind while having fun, tai-chi wheels for synchronisation to coordinate the brain and motor activities.



Overcome the loss of balance and hold the board steady and keep the bubble centred



Central column that also creates a meeting place



Unwind while boxing at the punchbag and punchball while enjoying a full muscle workout: arms, abs, legs

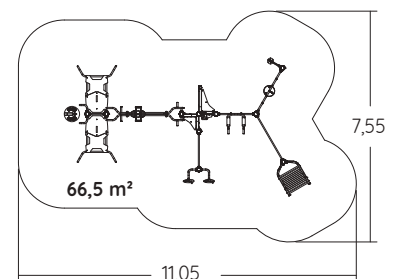
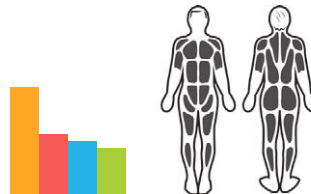
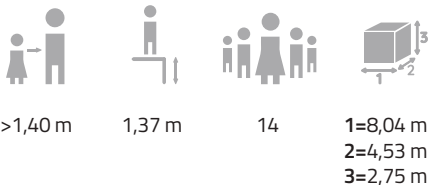
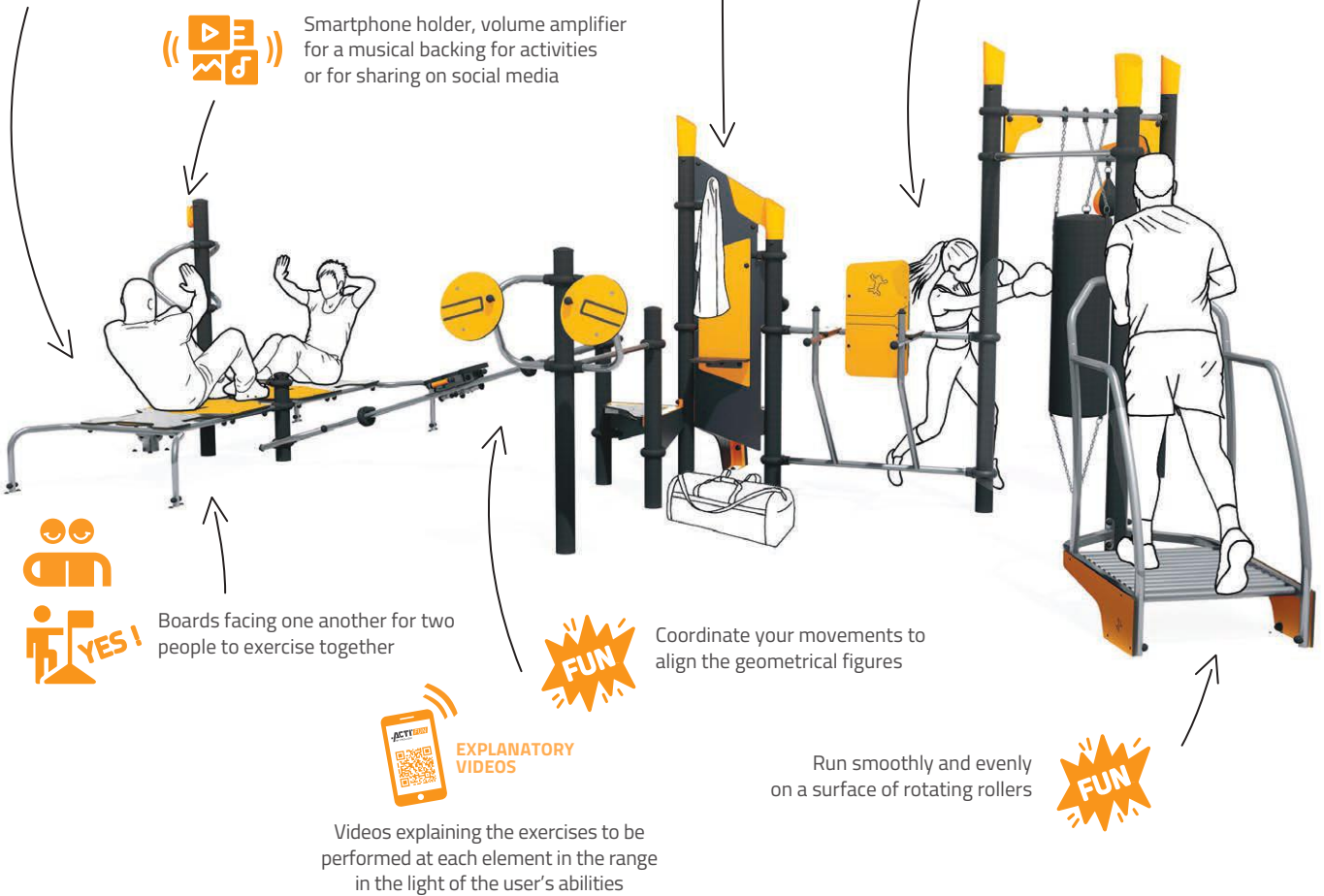

Multi-generational fun-sport station J37102®

A multi-generational station that encourages mixed-use. The variety of the different items of equipment, which complement one another perfectly, provides a sports and meeting place for everyone. The arm bike and the balance board are particularly suitable for older adults, while the dip bars and pull-up equipment will cater more for sports enthusiasts.



Smartphone holder, volume amplifier for a musical backing for activities or for sharing on social media



Central column that also creates a meeting place



EXPLANATORY VIDEOS



Overcome the loss of balance to hold the board steady and keep the bubble centred



Coordinate your movements to align the geometrical figures

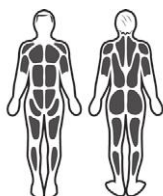
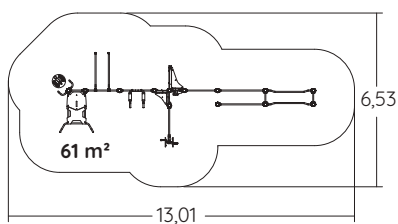

>1,40 m



1,10 m



11



1=9,86 m
2=3,55 m
3=2,35 m

Inclusive fun-sport station

J37101®

An inclusive station that brings together the maximum number of elements that can be accessed by wheelchair users: tai-chi wheels, shoulder disc, sloping monkey bars, dip bars and low horizontal bar.



Handles and opening suitable for wheelchair users



Central column that also creates a meeting place



Coordinate your movements to align the geometrical figures

Inclusive monkey bars for wheelchair users

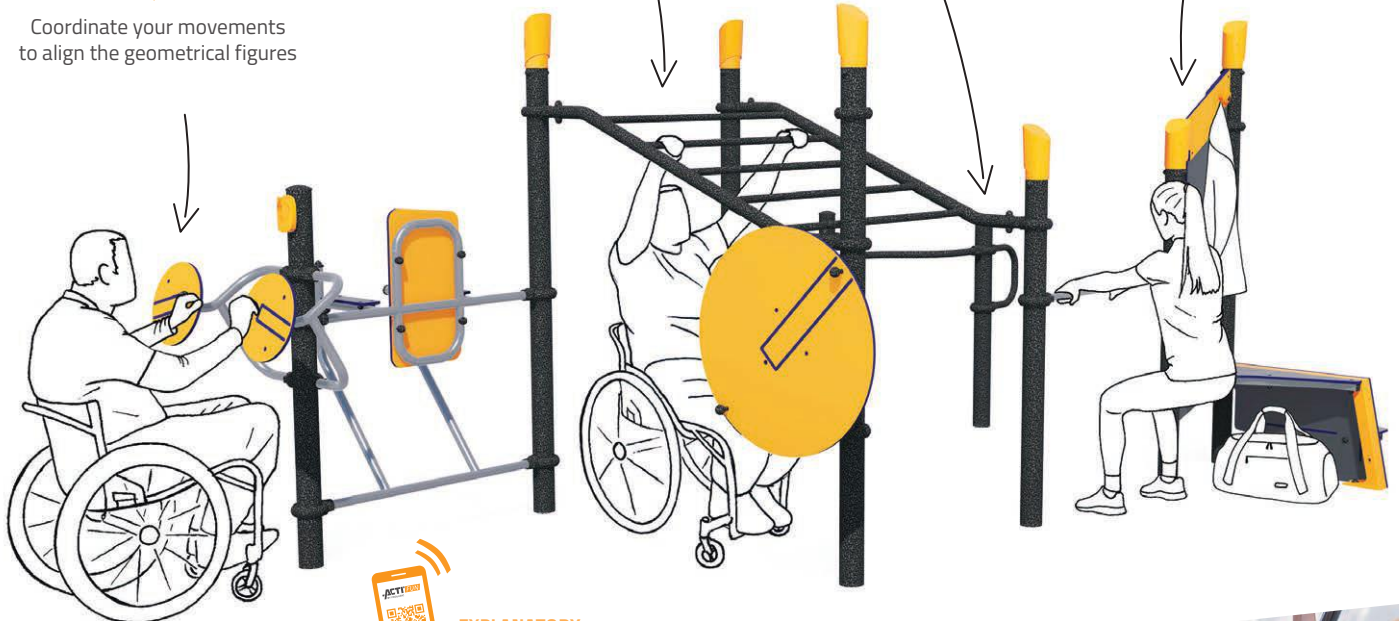

EXPLANATORY VIDEOS



>1,40 m



1,60 m



8



1=5,36 m
2=3,76 m
3=2,35 m

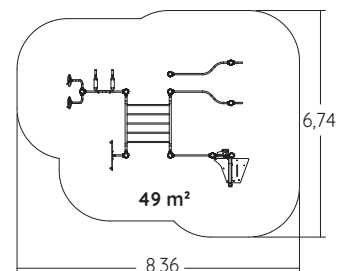
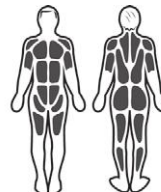

Compact fun-sport station J37100®

A compact fun-sport station organised around a central column with seat and coat rack. The station comprises of six items for an all-round athletic workout. The balance board, vertical jump and punchball give a recreational feeling on the activities and encourage athletic users to challenge one another.



The aim: to go and touch the highest target



Central column that also creates a meeting place



Unwind while boxing at the punchball while enjoying a full muscle workout: arms, abs, legs

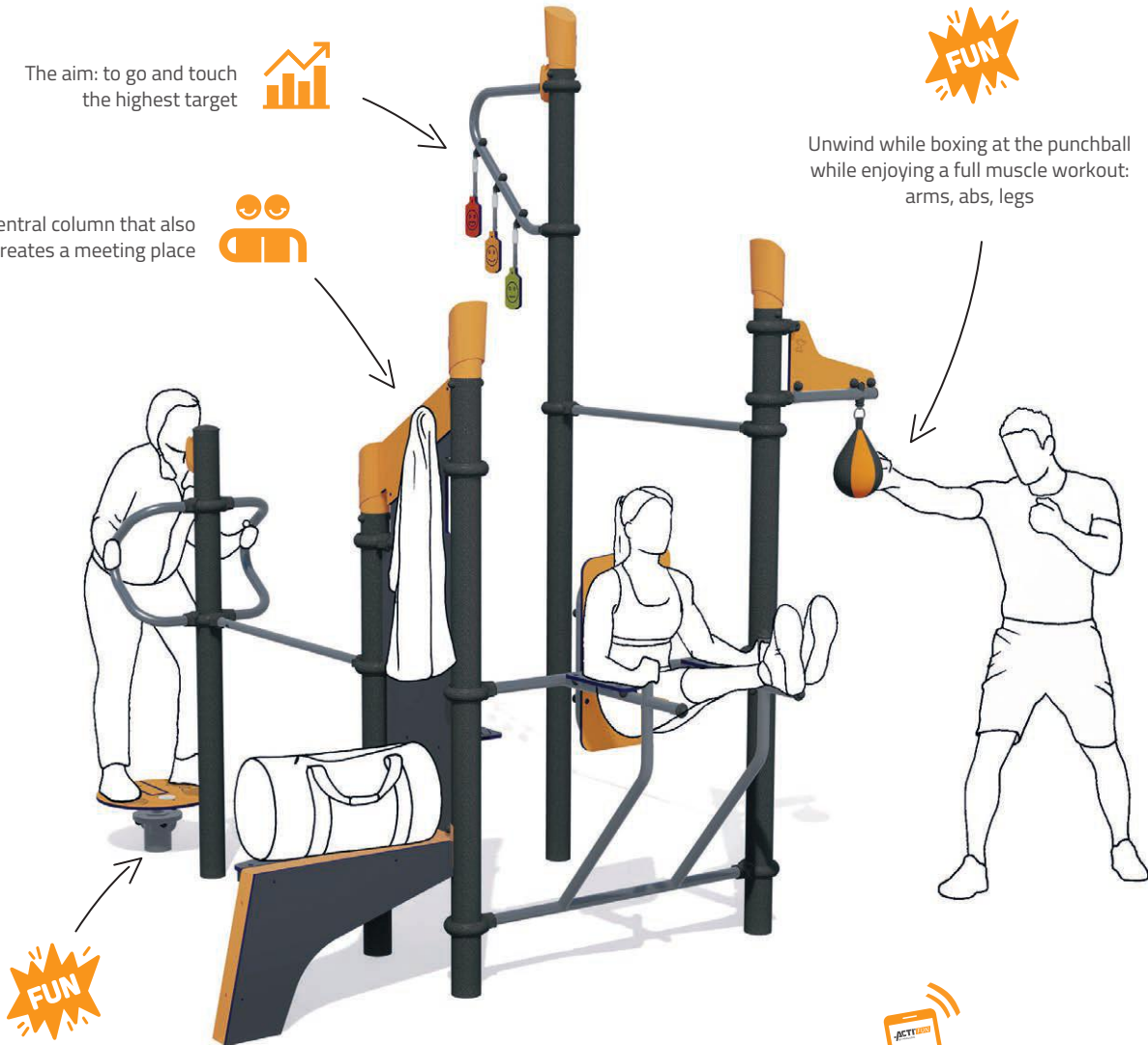

Overcome the loss of balance to hold the board steady and keep the bubble centred



EXPLANATORY VIDEOS

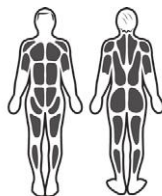
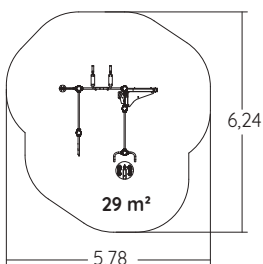

>1,40 m

1,10 m

6

1=2,77 m
2=2,60 m
3=3,45 m

Senior fun-sport station

J37105® **NEW**

A compact fun-sport station offering varied activities for gentle and progressive practice ideally suited to older users: balance with a balance board, coordination and joint mobilisation with Tai-Chi wheels, moderate strength intensity with an adjustable-resistance shoulder press.

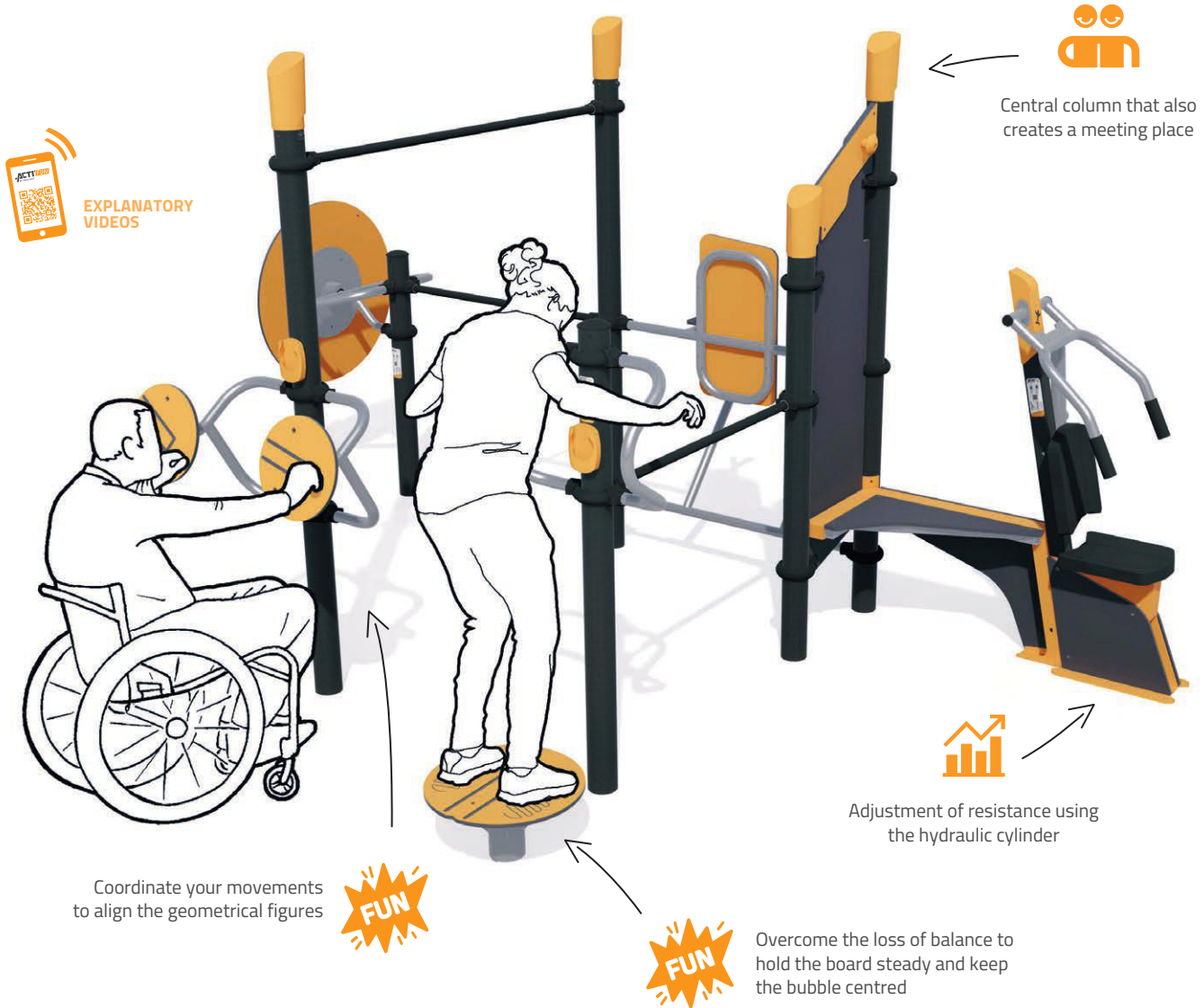

>1,40 m
 1,10 m
 10
 1=4,48 m
 2=3,21 m
 3=2,35 m

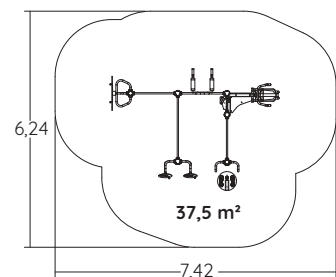



Compact Arm-Leg-Abs fun-sport station

NEW J37106®

A compact fun-sport station with equipment for a full-body workout: abs bench for the abdominal muscles, inclined bars for the arms and horizontal bars for the arms and a rowing machine for the legs. No particular physical abilities are required for this station making it suitable for beginners.

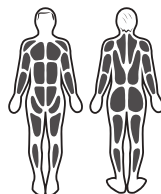
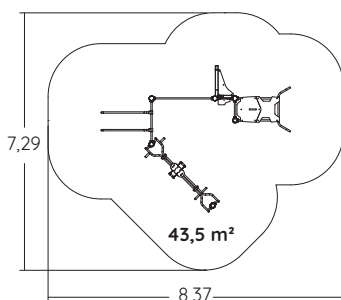
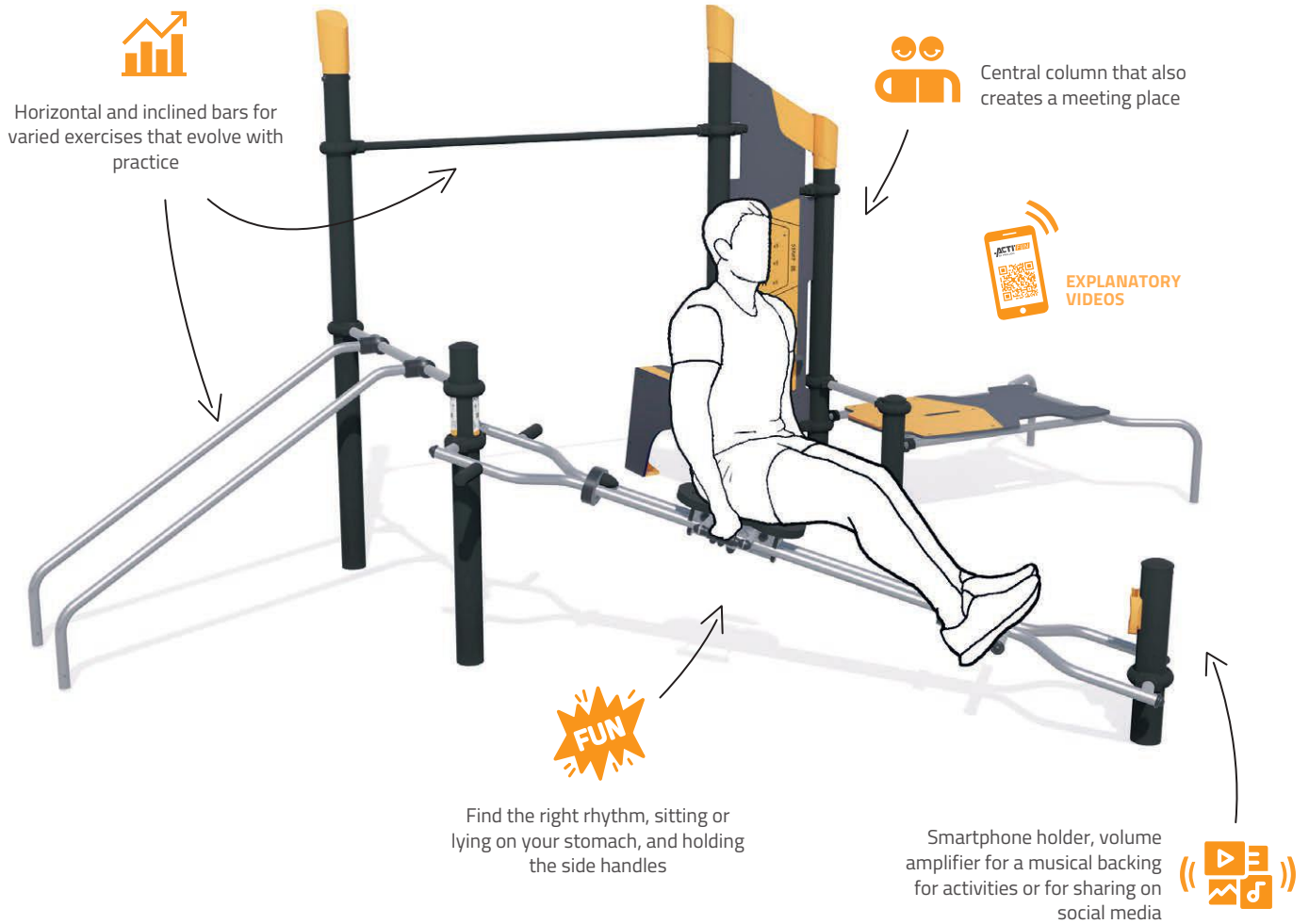

Strength fun-sport station

J37107[®] **NEW**

A fun-sport station designed to work on upper limb strength. The equipment offers a variable-resistance reclined bench press, power tower, freestyle horizontal bar and abs/push-up board. The overall workout is complemented by dynamic coordination and explosive strength exercises on a punchbag and speedball.



Unwind while boxing at the punchbag and punchball while enjoying a full muscle workout: arms, abs, legs



Group challenges

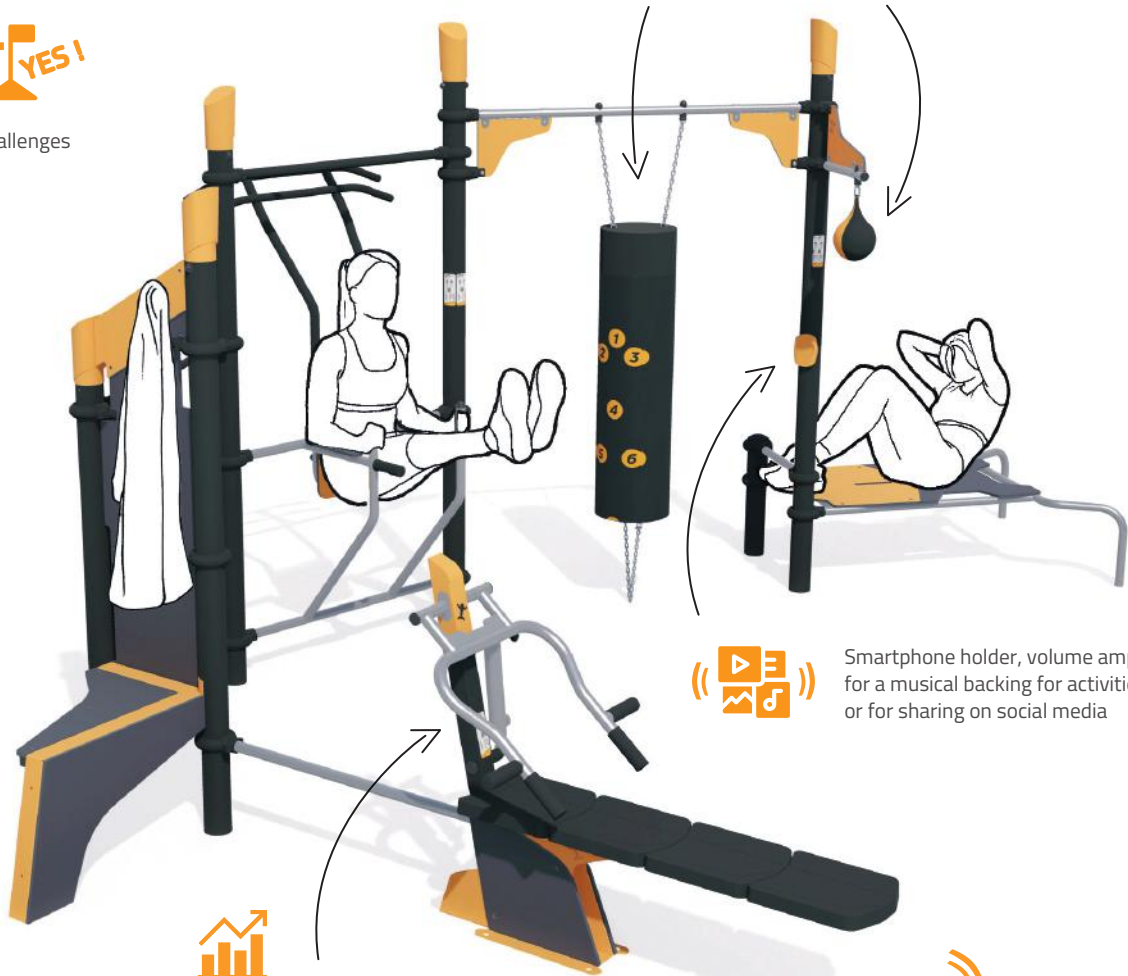

Smartphone holder, volume amplifier for a musical backing for activities or for sharing on social media



Adjustment of resistance using the hydraulic cylinder



EXPLANATORY VIDEOS



>1,40 m



1,27 m



10



1=6,52 m
2=3,96 m
3=2,74 m

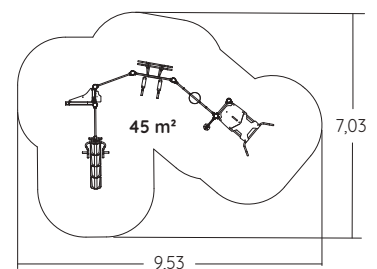
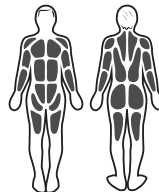



Sports centre fun-sport station

NEW J37108®

A fun-sport station offering a real outdoor gym. Covers all dimensions of sport (Strength, Balance, Coordination, Cardio) and all levels of ability (from beginners to the experienced). The number, variety and diversity of the activities help to build user loyalty and this combination can accommodate a large number of users at the same time.

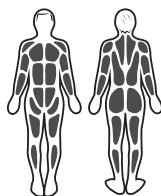
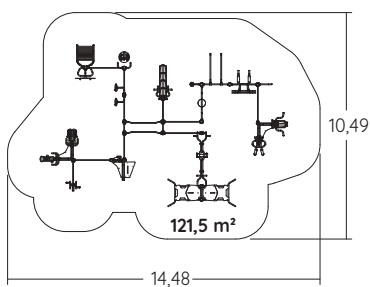



Bench press

J37220® **NEW**



>1,40 m 0,50 m

1 17 m² 1=1,65 m
2=0,83 m
3=1,24 m

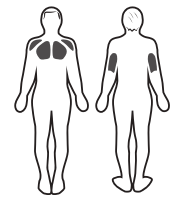
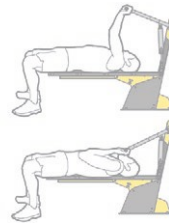

Squat

J37210® **NEW**



>1,40 m 0 m

1 11 m² 1=0,75 m
2=0,51 m
3=1,58 m

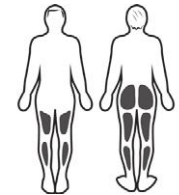
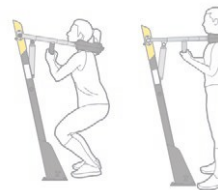

Overhead press

J37211® **NEW**



>1,40 m 0,50 m

1 13,5 m² 1=0,78 m
2=1,06 m
3=1,53 m

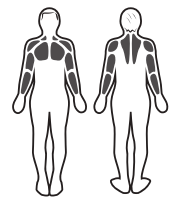
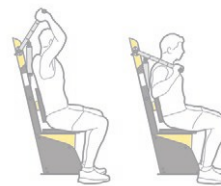

Chest press

J37218® **NEW**



>1,40 m 0,50 m

1 11,5 m² 1=0,78 m
2=0,57 m
3=1,53 m

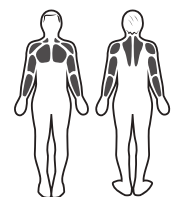
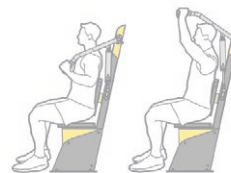

Apparatus with a hydraulic cylinder allowing adjustment of loads to be lifted, pulled or pushed. The load levels (up to 60 kg) guarantee individually adapted effort that increases with practice.

◀ The polyurethane foam seats and backrests ensure lasting comfort. Polyurethane foam is a resistant, anti-perspiration shape memory material that helps to prevent overheating.





1=0,77 m
2=0,57 m
3=1,49 m

>1,40 m

0,30 m

1

11,5 m²

Stepper

NEW J37216®

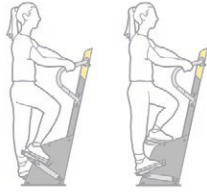
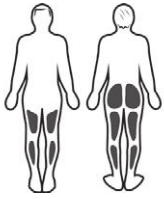

1=0,93 m
2=0,57 m
3=1,49 m

>1,40 m

0,78 m

1

12 m²

Bike

NEW J37217®

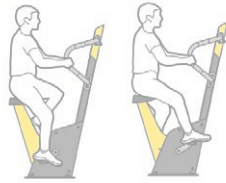
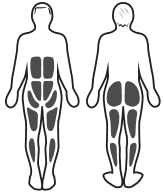

1=1,02 m
2=0,67 m
3=1,43 m

>1,40 m

0,35 m

1

13,5 m²

Elliptical trainer

NEW J37215®

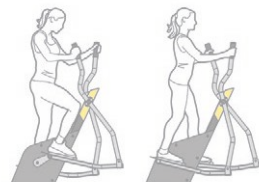
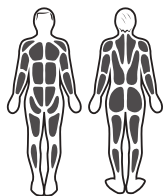

1=1,39 m
2=0,82 m
3=1,38 m

>1,40 m

0,52 m

1

17,6 m²

Air walker

NEW J37209®

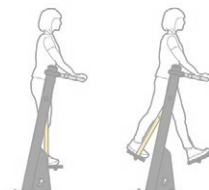
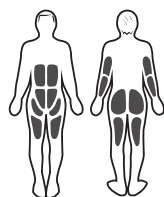



Balance board

J37203[®] **NEW**



>1,40 m <0,60 m

1 12 m² 1=0,82 m
2=0,63 m
3=2,12 m

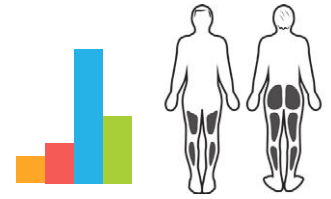
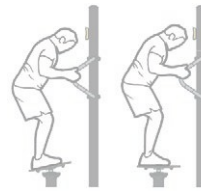

Arm bike

J37205[®] **NEW**



>1,40 m <0,60 m

1 11 m² 1=0,66 m
2=0,35 m
3=1,33 m

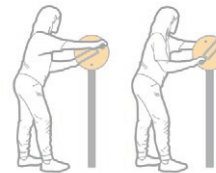

Tai-Chi wheels

J37206[®] **NEW**



>1,40 m <0,60 m

1 12,5 m² 1=1,02 m
2=0,54 m
3=1,62 m



Shoulder disc

J37204[®] **NEW**



>1,40 m <0,60 m

1 12 m² 1=0,90 m
2=0,63 m
3=1,80 m

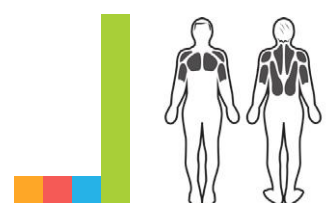



1=1,65 m
2=1,28 m
3=0,64 m

>1,40 m

<0,60 m

1

18 m²

Abs board/Push-ups

NEW J37207[®]

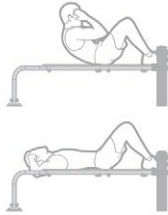
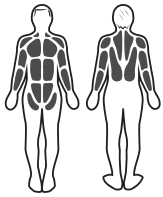

1=3,15 m
2=1,28 m
3=0,64 m

>1,40 m

<0,60 m

2

24,5 m²

Double abs board/Push-ups

NEW J37208[®]

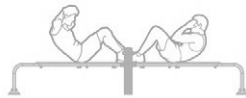
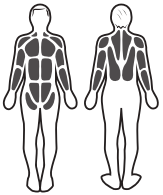

1=1,61 m
2=0,65 m
3=0,98 m

>1,40 m

0,50 m

1

14,9 m²

Abs bench

NEW J37219[®]

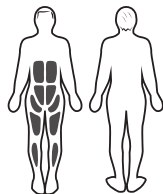

1=2,61 m
2=0,76 m
3=1,22 m

>1,40 m

0,95 m

1

19,5 m²

Rowing machine

NEW J37202[®]

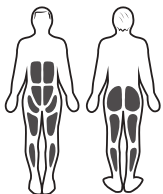

1=2,26 m
2=1,28 m
3=0,29 m

>1,40 m

1 m

1

22 m²

Fitness trampoline

NEW J37200[®]

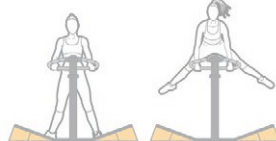
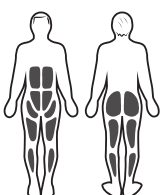



Runner

J37201[®] **NEW**



>1,40 m <0,60 m

1 13,5 m² 1=1,14 m
2=0,81 m
3=2,12 m

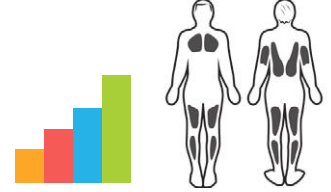
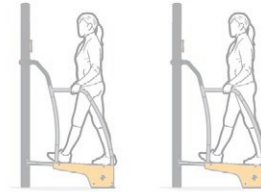

Power tower

J37212[®] **NEW**



>1,40 m 1,27 m

2 17 m² 1=1,45 m
2=1,26 m
3=2,32 m

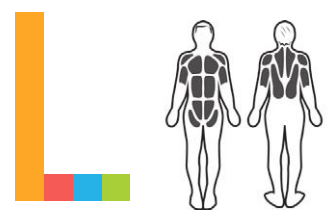
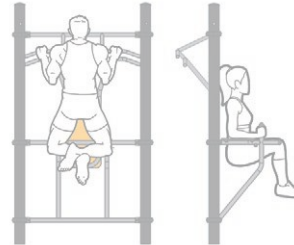

Sloping bars

J37213[®] **NEW**



>1,40 m 1,07 m

1 18 m² 1=1,51 m
2=1,45 m
3=1,22 m

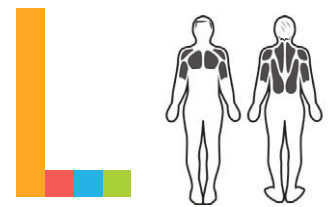
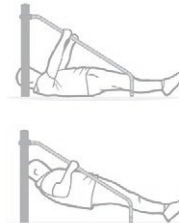

Punchbag

J37214[®] **NEW**



>1,40 m <0,60 m

1 20 m² 1=2,63 m
2=0,89 m
3=2,75 m

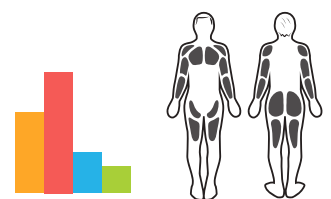
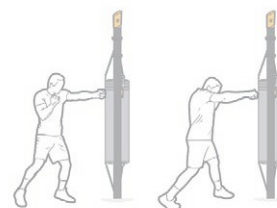

Over to you!

Create your customised **ACTI'Fit**[®] station, from a choice of 30 pieces of apparatus



 Abs board/
Push-ups



 +  Power tower





 +  Bike



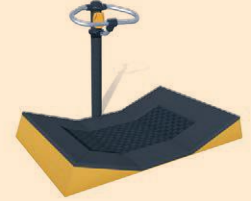

 +  Squat



 +  Fitness trampoline



  ✓ Muscle strengthening

 ✓ Heart health

 ✓ Coordination

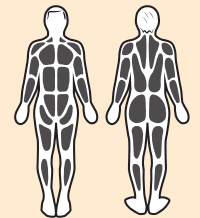

- ▶ Determine the number of pieces of apparatus
- ▶ Define your users' sports objectives
- ▶ Define the types of activities
- ▶ Define the inclusion level

The

Position 1 or 2 modules at a distance from the main station to create a quiet sports area for users who prefer more individual activities.

Can be combined with the ACTI'Street range



Contact us
to finalise
your project!



Motivations to enjoy fun-sport



ACTI'FUN app showing the scope of use of the equipment by means of videos.



Volume-amplifying smartphone holder for selfies, playing music, streaming videos, etc.



Multiple activities possible on the freestyle and aerial modules.



Various levels of equipment difficulty with explanatory videos.



Group activities.
Community support.



Adaptation and selection of apparatus to encourage contact and mixing.



Challenges via the ACTI'FUN app.



ACTI'Street[®]

BY PROLUDIC

By working together with the International Street Workout and Calisthenics Federation (WSWCF), Proludic has designed an array of high-performance equipment that is geared toward the needs of beginners and the more experienced.



Technical aspects such as height, diameter, spacing, slope, materials and coating have all been expertly defined and validated in cooperation with top-level athletes.

- ▶ 23 exercise modules are available to build the best bespoke Street Workout combinations.
- ▶ The structures address issues of current social importance by providing mixed, multi-generational and inclusive Street Workout zones.
- ▶ The entire range is certified by the World Street Workout and Calisthenics Federation for both Recreational and Professional use.

“ One of the main objectives of the WSWCF is the creation of new street workout training facilities of the highest standard worldwide. Facilities that are inclusive and suitable for people of all ages, genders and abilities. Together with Proludic, we have designed the new “Street Workout” range. It’s innovative, inclusive design sets a new benchmark for street workout training facilities. ”

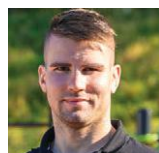

Rolands Kikors,
Vice-President and Member
of the Educational Board
of the World Street Workout
and Calisthenics Federation.



- ➔ Check out the partnership between Proludic and WSWCF and the benefits for Street Workout fans at proludic.com.



Technical aspects

- Parallel bars feature variable spacings so that exercises can be tailored to each user's body shape (women, men, or teenagers).

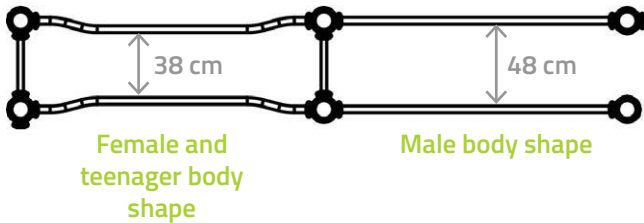

The bar diameter adapts to different types of exercises (pull-ups, dips, leg raises, turns, etc.) and guarantees excellent handling for all categories of users.

For pull-ups:

The federation recommendation: 34mm diameter

For dips:

The federation recommendation: 40mm diameter



Suitably adapted height



The incorporation of collars allows easier access for teenagers from 14 years of age and/or for smaller individuals.



Comfortable bars offering a secure grip are essential for Street Workouts. Proludic uses an epoxy coating to guarantee grip and safety during use.

Modules specifically designed for individuals with reduced mobility can be used to create inclusive Street Workout areas.



Simplified access



Fully-featured, inclusive combination J5223

The most complete combination with the maximum equipment configuration. Inclusive and accessible irrespective of body shape and the user's level of expertise, it permits users to practice all types of freestyle and power exercises.



Inclusive monkey bars and access to parallel bars adapted for wheelchair users

Sequence of horizontal bars for performing freestyle figures

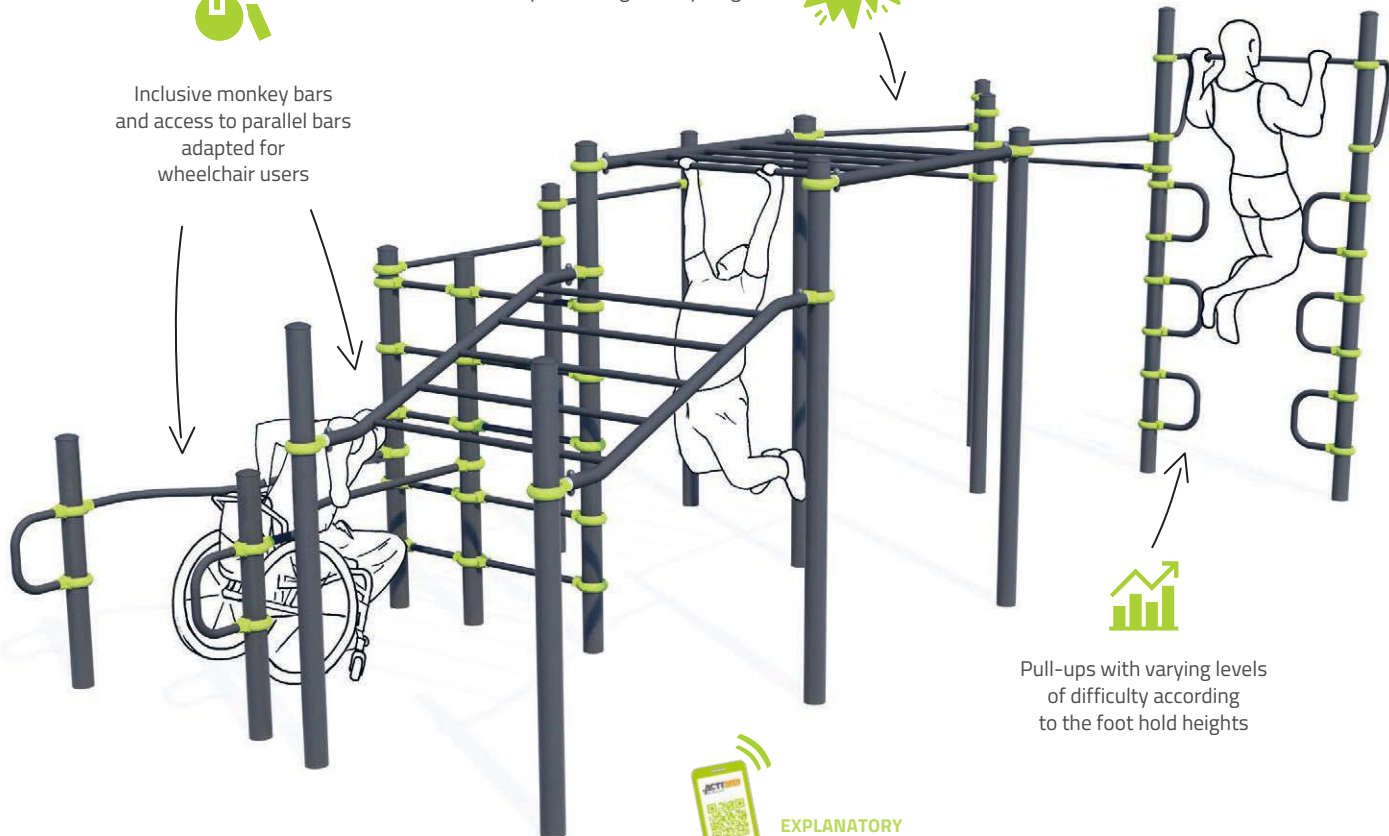

Pull-ups with varying levels of difficulty according to the foot hold heights

Videos explaining the exercises to be performed at each focal point on the equipment dependant upon the user's ability

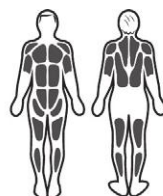
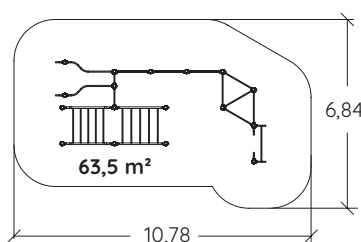

>1,40 m

1,70 m

17

1=7,64 m
2=3,76 m
3=3,02 m



Freestyle combination

J5220

The combination consists of bars for pull-ups and human flag exercises. Intended for enthusiasts wanting to practice their freestyle moves or static figures.



Sequence of horizontal bars arranged at different heights to permit freestyle figures



Variable bar heights and access step



EXPLANATORY VIDEOS



>1,40 m



1,40 m



9



1=3,61 m
2=3,52 m
3=2,52 m

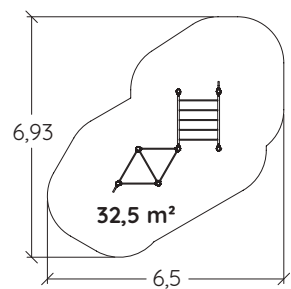
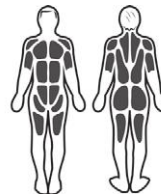



Mixed combination J5222

This linear combination consists of two areas, each of which promotes mixed usage. Low elements can be used by beginners, while high elements are intended for experienced athletes.



Parallel bars with variable spacings and heights adapted to different body shapes



Horizontal bars are positioned at three different heights to encourage group activities



Bar at 2.22m for users who want to practice freestyle moves

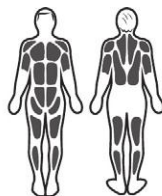
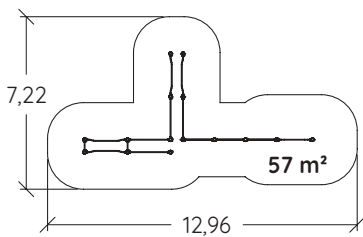
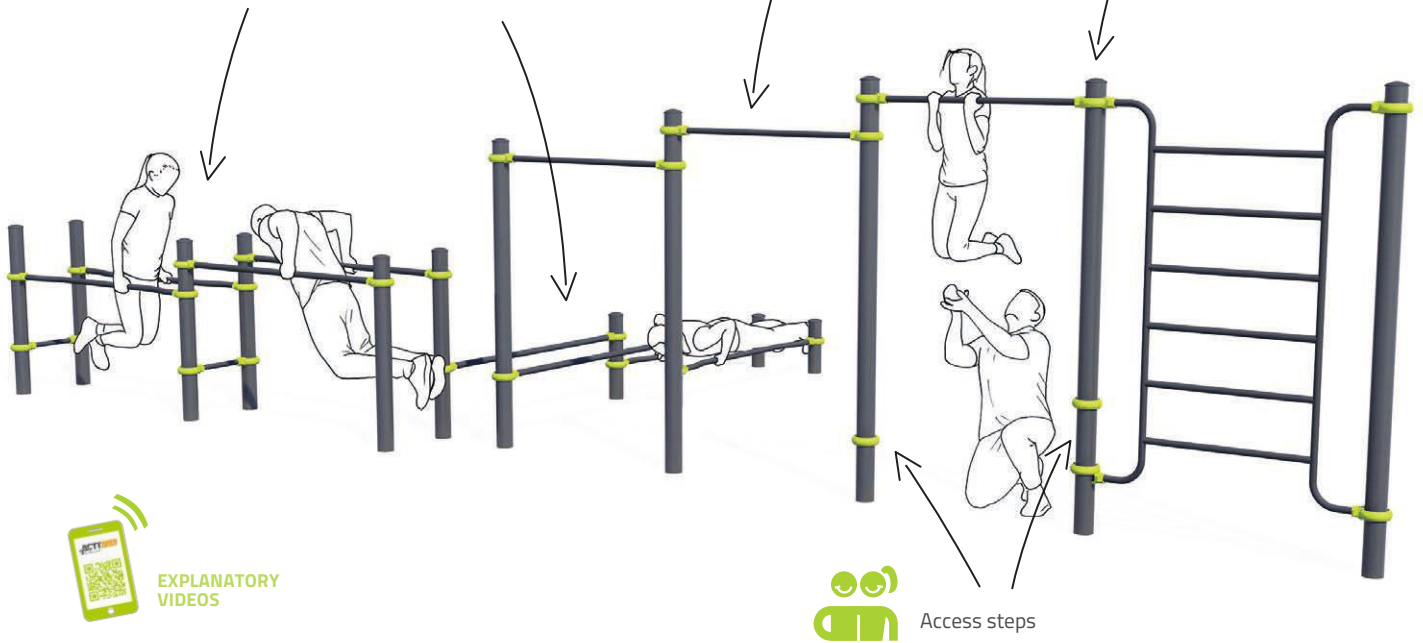

>1,40 m



2 m



9



1=9,68 m
2=3,75 m
3=2,32 m

Compact combination J5216

A compact, multipurpose combination with equipment that is accessible to beginners, wheelchair users and experienced athletes.



Inclusive monkey bars for wheelchair users



Sequence of horizontal bars for performing freestyle figures



Compact structure to help bring people together



>1,40 m



1,70 m



9



1=5,26 m
2=3,26 m
3=2,32 m

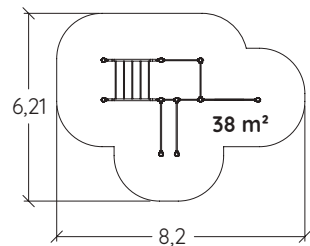
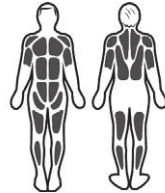

Combination for all levels J5218

A multi-purpose combination with low components for exercises allowing access for all users (abs bench, low bars, Swedish walls, parallel bars), and challenge components (Swedish wall for flag exercises and high pull-up bars) for experienced athletes.



Bar at 2.22m for users who want to practice freestyle moves



EXPLANATORY VIDEOS

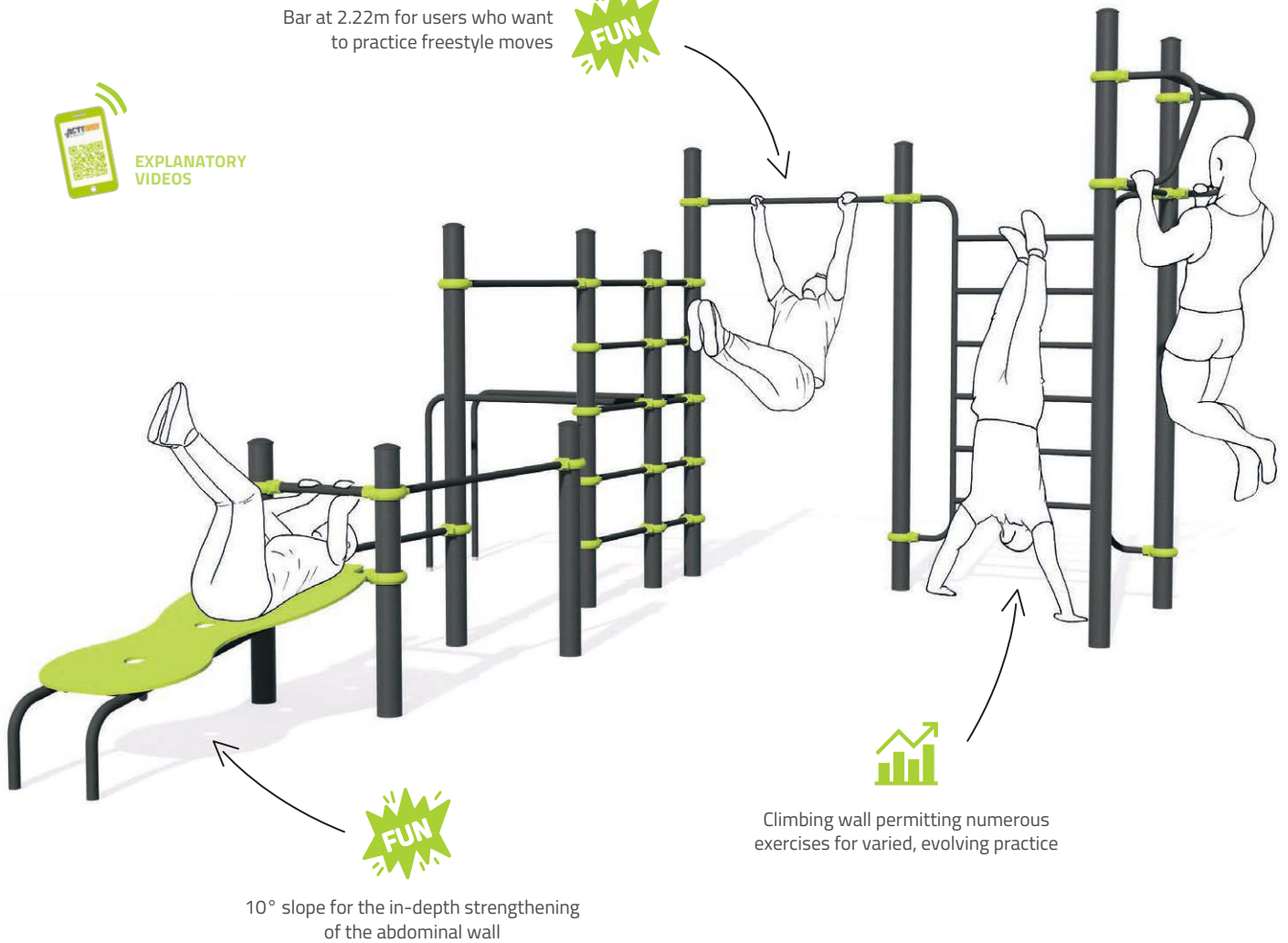

10° slope for the in-depth strengthening of the abdominal wall



Climbing wall permitting numerous exercises for varied, evolving practice

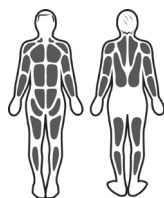
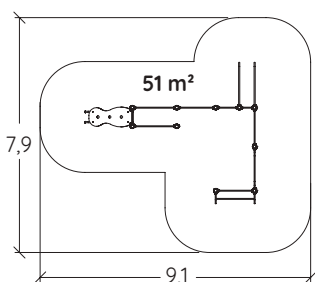

Inclusive combination 1
J5221

A combination of inclusive monkey bars and parallel bars with variable spacing for inclusive, mixed usage.



Inclusive monkey bars for wheelchair users

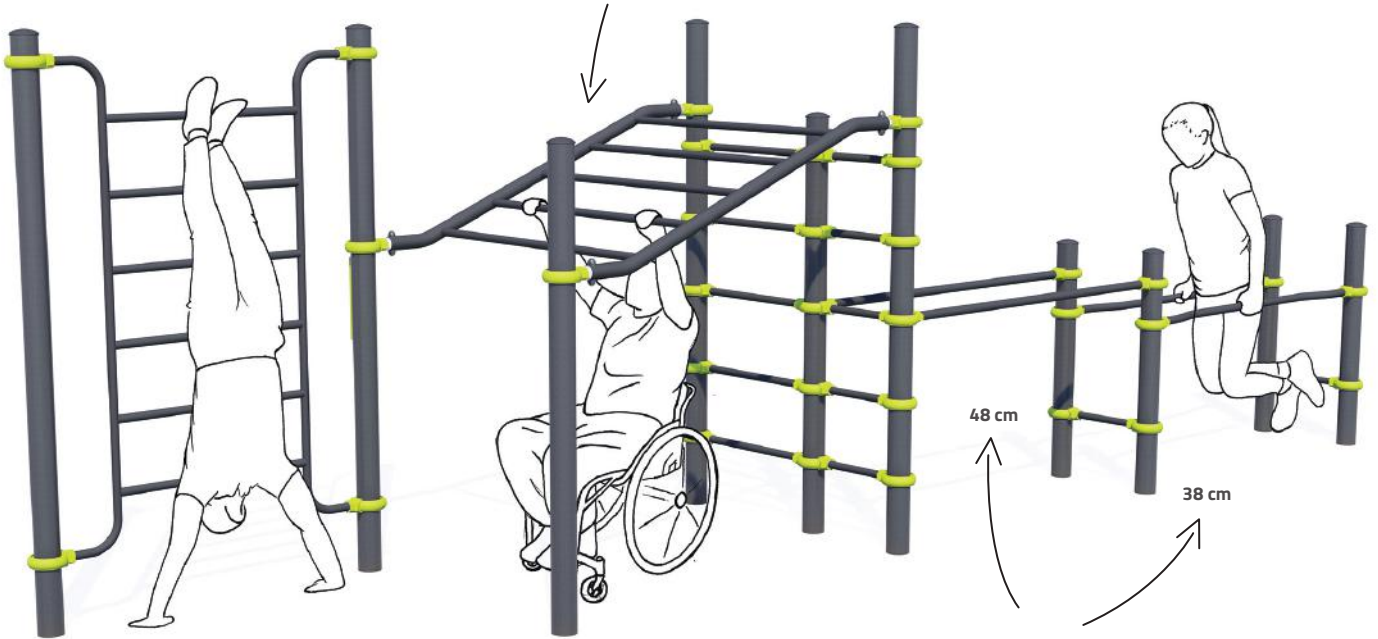

EXPLANATORY VIDEOS



Spacing adapted to different body shapes



>1,40 m



2 m



8



1=7,13 m
2=1,46 m
3=2,32 m

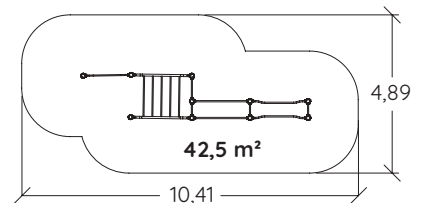
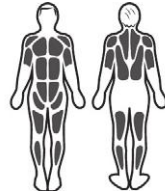



Inclusive mixed combination J5224

Parallel bars with variable spacings and heights adapted to different body shapes



A low combination, ideal for beginners, allowing easy exercises with 4 parallel bar components, one inclusive and two tailored to the female body shape, as well as 2 horizontal bar sets, in a low design to allow access for users with all levels of physical ability.

Handles and opening suitable for wheelchair users

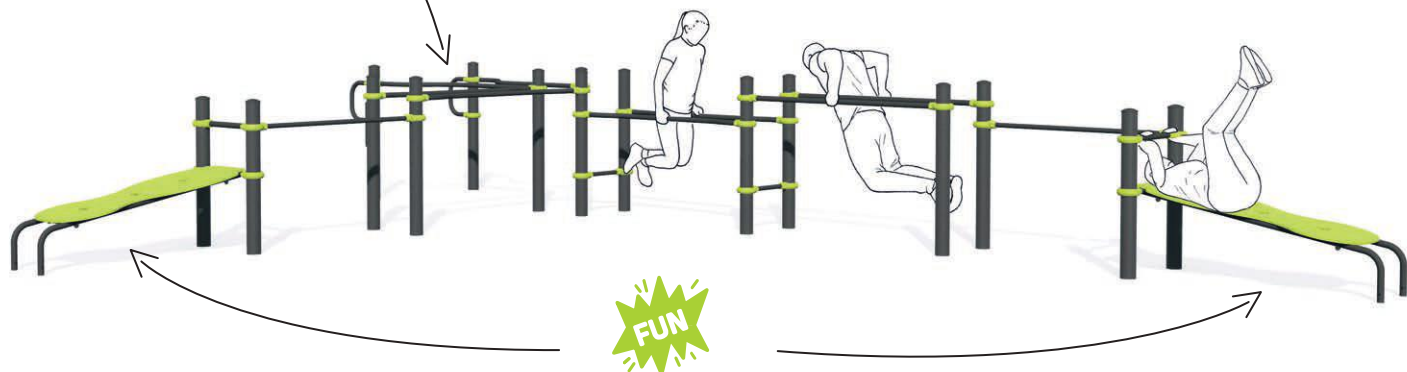

10° slope for the in-depth strengthening of the abdominal wall



EXPLANATORY VIDEOS

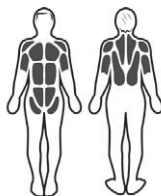
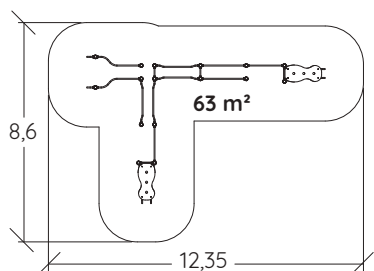
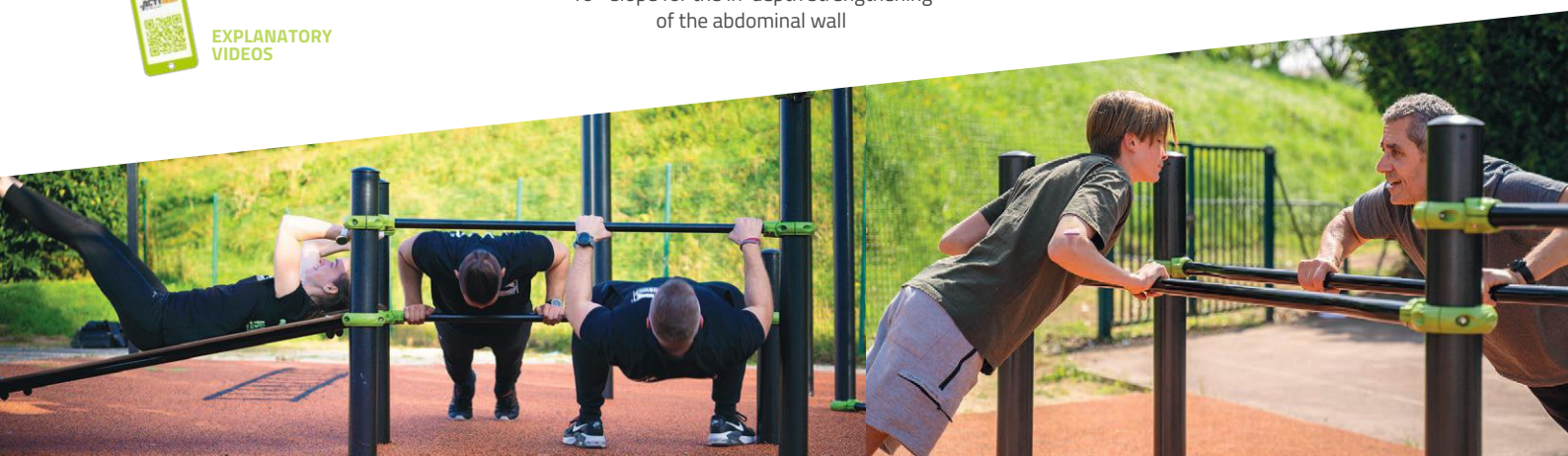

>1,40 m



1,10 m



8



1=9,36 m
2=5,83 m
3=1,22 m

Combination for experienced athletes
J5217

A fully-featured combination for experienced enthusiasts with a large number of hanging activities.



Sequence of horizontal bars at 2.32m and 2.72m for performing freestyle figures



Climbing wall permitting numerous exercises for varied, evolving practice

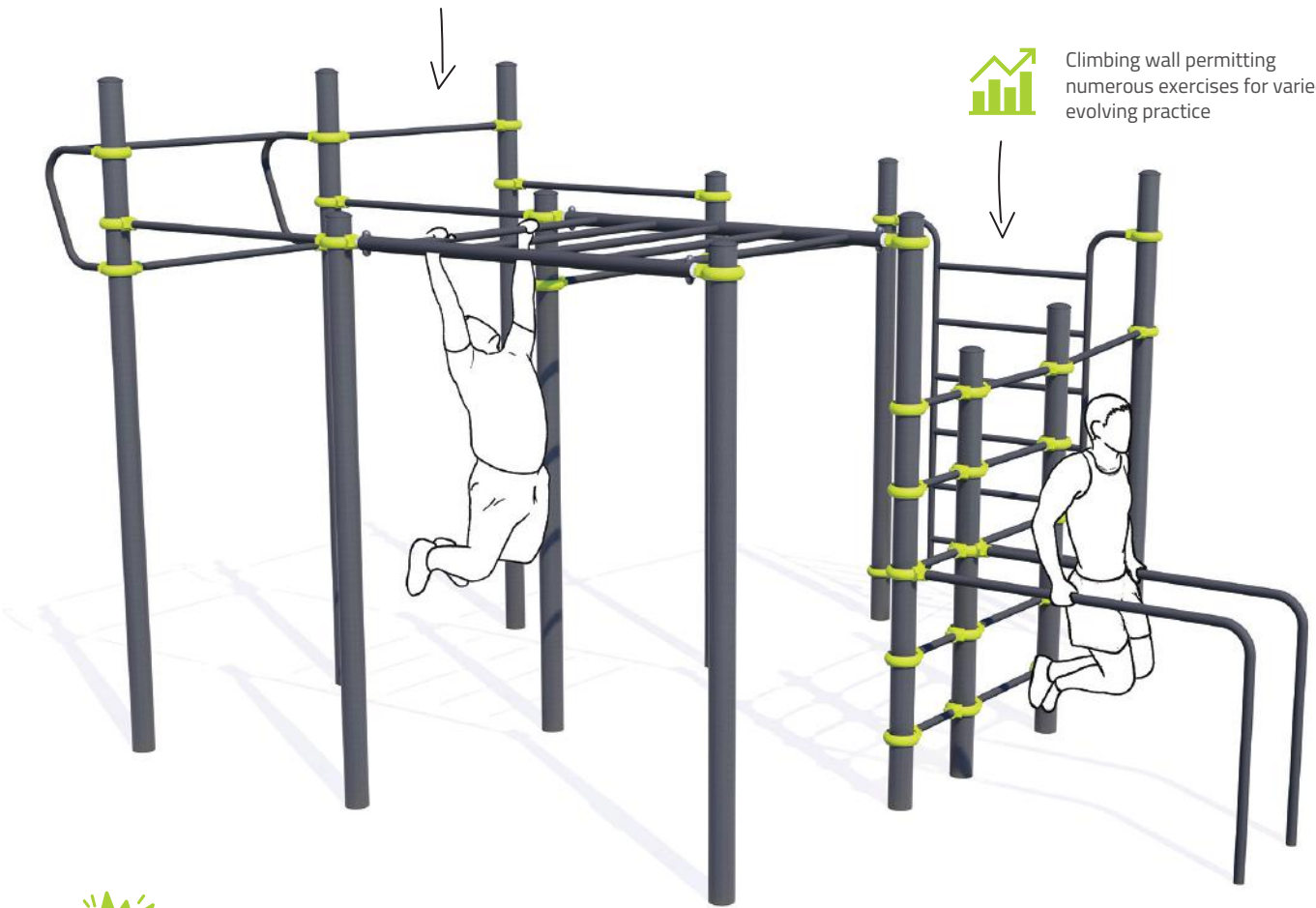

Wide variety of equipment



Group challenges



EXPLANATORY VIDEOS

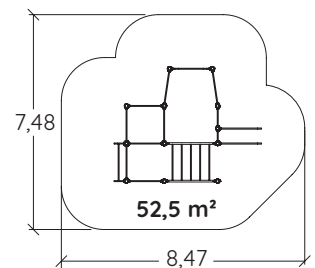
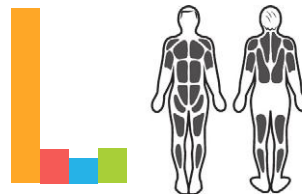
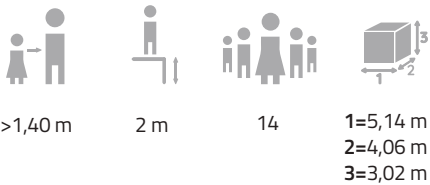



Inclusive combination 2

J5219

A combination for all levels including low elements for beginners, inclusive elements for wheelchair users and challenging elements (bars for human flag exercises and freestyle use) for enthusiasts.



Inclusive monkey bars for wheelchair users



EXPLANATORY VIDEOS

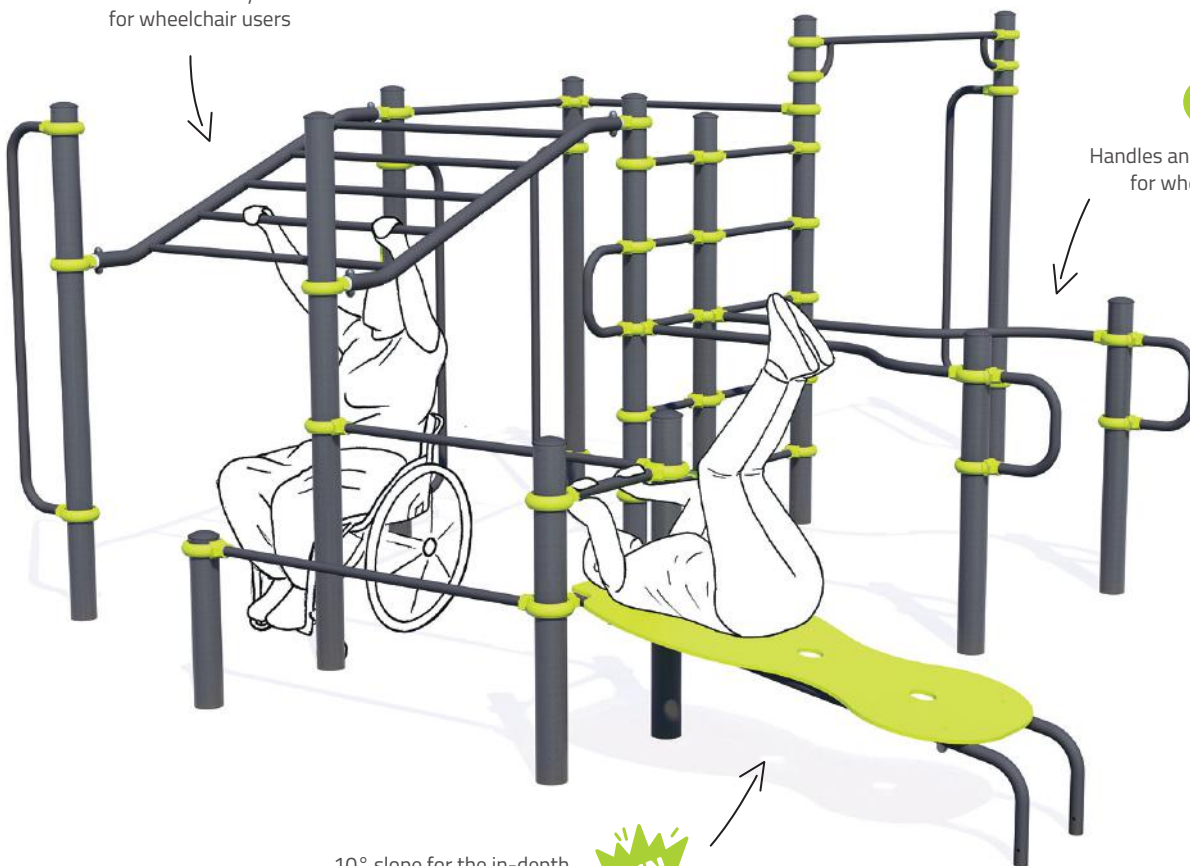

Handles and opening suitable for wheelchair users

10° slope for the in-depth strengthening of the abdominal wall

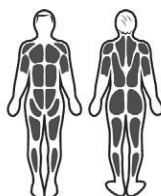
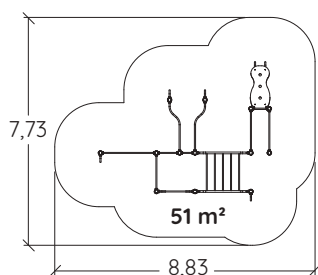

>1,40 m



1,70 m



16



1=5,88 m
2=4,73 m
3=2,32 m

Horizontal bars combination J5225

A combination of 3 horizontal bar sets of different heights (1.80m, 2m and 2.20m) for users of all sizes, men and women.



Sequence of horizontal bars for performing freestyle figures

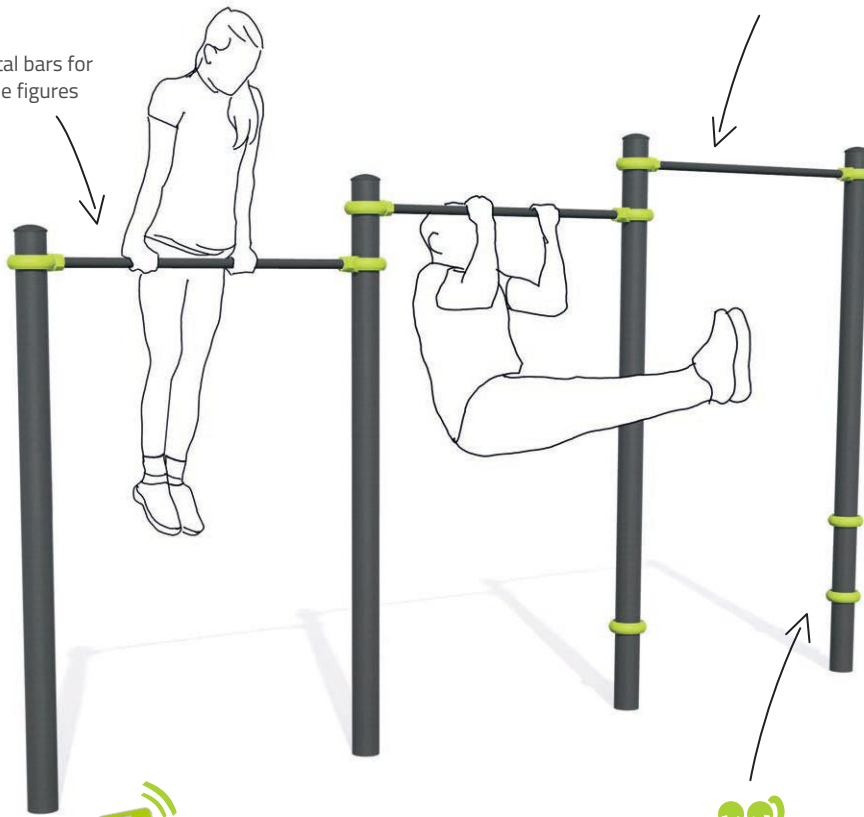

EXPLANATORY VIDEOS



Horizontal bars are positioned at three different heights to encourage group activities



Parallel bars with variable spacings and heights adapted to different body shapes

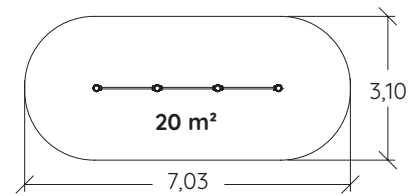
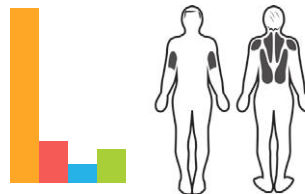
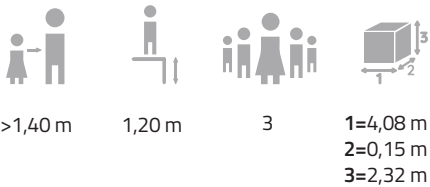

Over to you!

Create your customised **ACTI'Street**[®] combination
BY PROLUDIC

+ 20 pieces of apparatus available

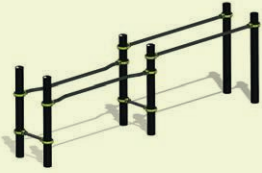

Parallel bars

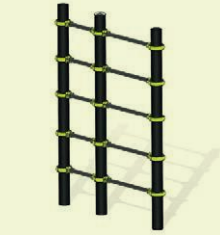

Wall bars



Inclusive monkey bars



Climbing wall

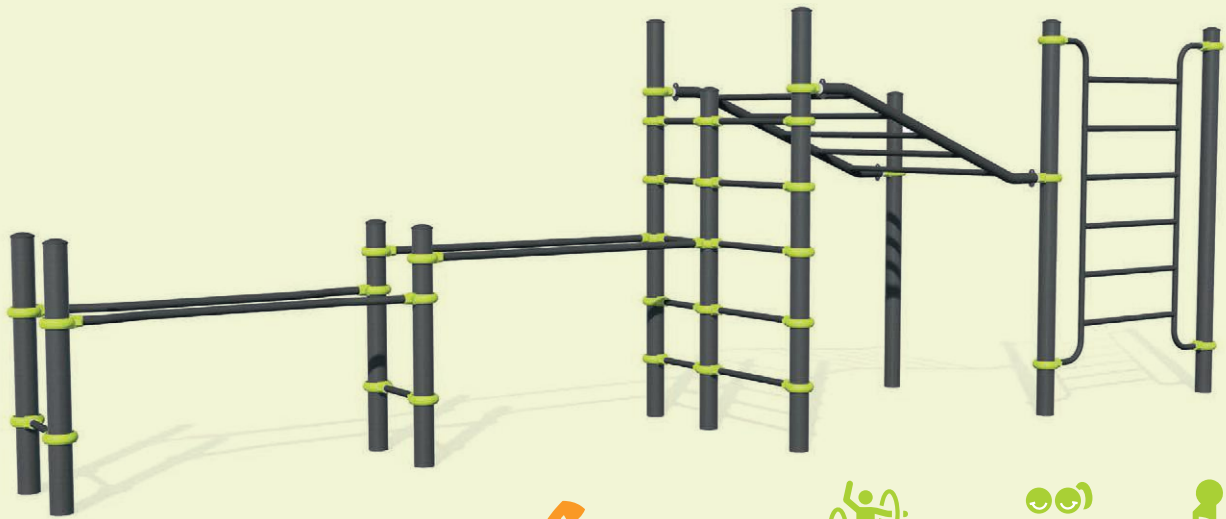

✓ Muscle strengthening



✓ Coordination



✓ Mixed



✓ Inclusive

- ▶ Determine the number of pieces of apparatus
- ▶ Define your users' sports objectives
- ▶ Define the types of activities
- ▶ Define the inclusion level

Can be combined with the ACTI'Fit range



Contact us to finalise your project!

Recommendation

Include high bars to allow activities using suspension straps and resistance bands for strength training.

The +

Include a smartphone holder for musical accompaniment to sports.

Ideal for creating atmosphere, setting the pace for activities or switching off in a musical bubble!



Motivations to enjoy fun-sport



Jumping, running, balance, stretching, slalom, crawling, climbing... lots of activities can be linked in a sequence.



Different levels of difficulty for the circuits and modules.



Group activities.
Relays.



Group activities that encourage people to mix.



Timed challenges.
Parallel and simultaneous trails.



ACTI'Ninja[®] BY PROLUDIC

The ACTI'Ninja trails are fun-sport obstacle courses designed to encourage as many people as possible to take up physical activity.

They consist of obstacles that can be linked together and that need to be overcome using strength, balance, endurance, or flexibility. Each person progresses at his or her own pace or tries to beat the stopwatch triggered at the starting line: depending on the sports targets and usage context.

▶ The great variety of available modules makes it possible to adapt the level of difficulty of the trails to users' ages.

- ▶ When designing a fitness trail, various exercises such as hurdles, pull-ups on horizontal bars or hanging ladders, stretching on Swedish walls, or gaining speed in slalom turns provide a complete workout for several muscle groups.
- ▶ The Stopwatch module invites users to challenge their friends.
- ▶ The surface graphic presentation with a coloured, learning-oriented and soft feel makes it possible to create a dynamic, challenging environment.
- ▶ The designs encourage sharing with family or friends and allow accompanying persons to track and encourage athletes over the entire course.

M-sized Ninja Trail

The **M-sized Ninja Trail** has been designed for young children (6+) and mainly includes balance modules. It can be designed as a return circuit.

This trail has been optimised for small spaces and can be installed on a lawn.

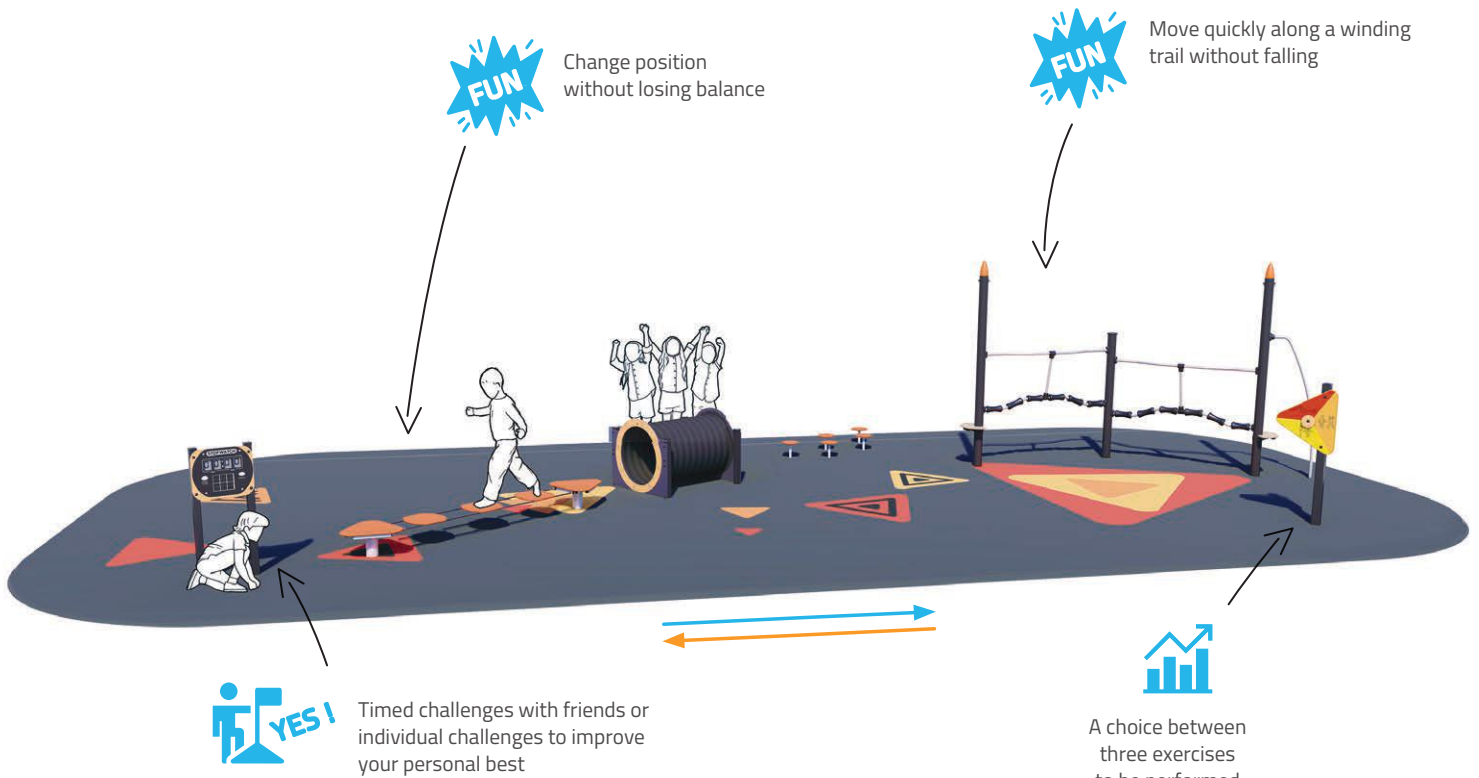

6+
 1 m
 13
 >1,40 m

DIFFICULTY



* EN 1176: 6+ / 8+
EN 16630: >1,40 m



L-sized Ninja Trail

The L-sized Ninja Trail has been designed for children aged 8 years or older. It offers a sequence of different physical activities with variable levels of difficulty. Its circular design encourages simultaneous use in both directions before crossing the centrally located ramp at the end of the trail.

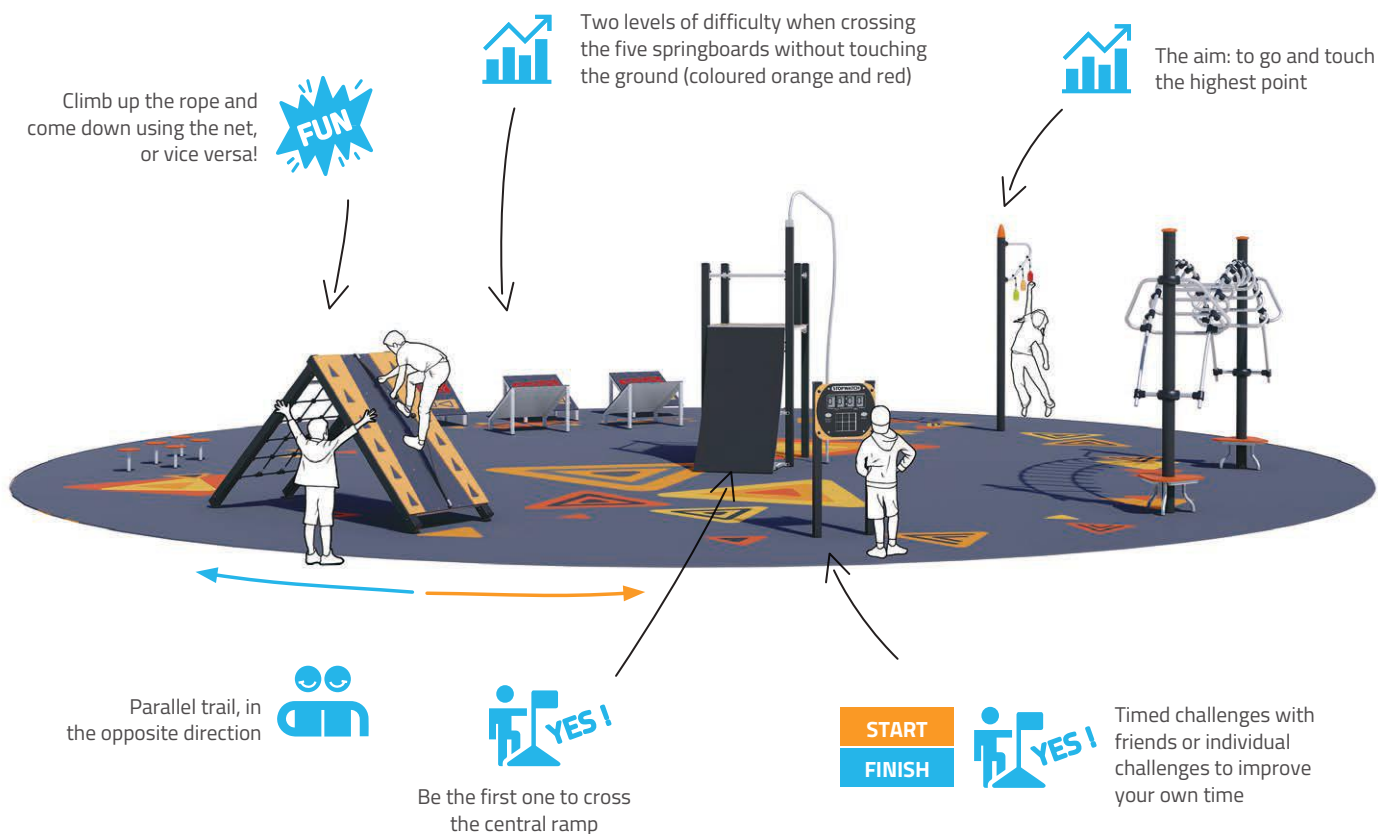

8+
>1,40 m

2,40 m

18

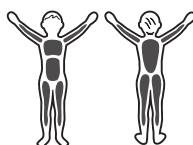

DIFFICULTY



XXL-sized Ninja Trail

The **XXL-sized Ninja Trail** is a full-scale trail offering the maximum challenge with 13 elements to be overcome. The variety of the modules calls on different dimensions of athletic prowess. The way they are sequenced requires frequent changes of rhythm: this is a genuine fun-sport environment.

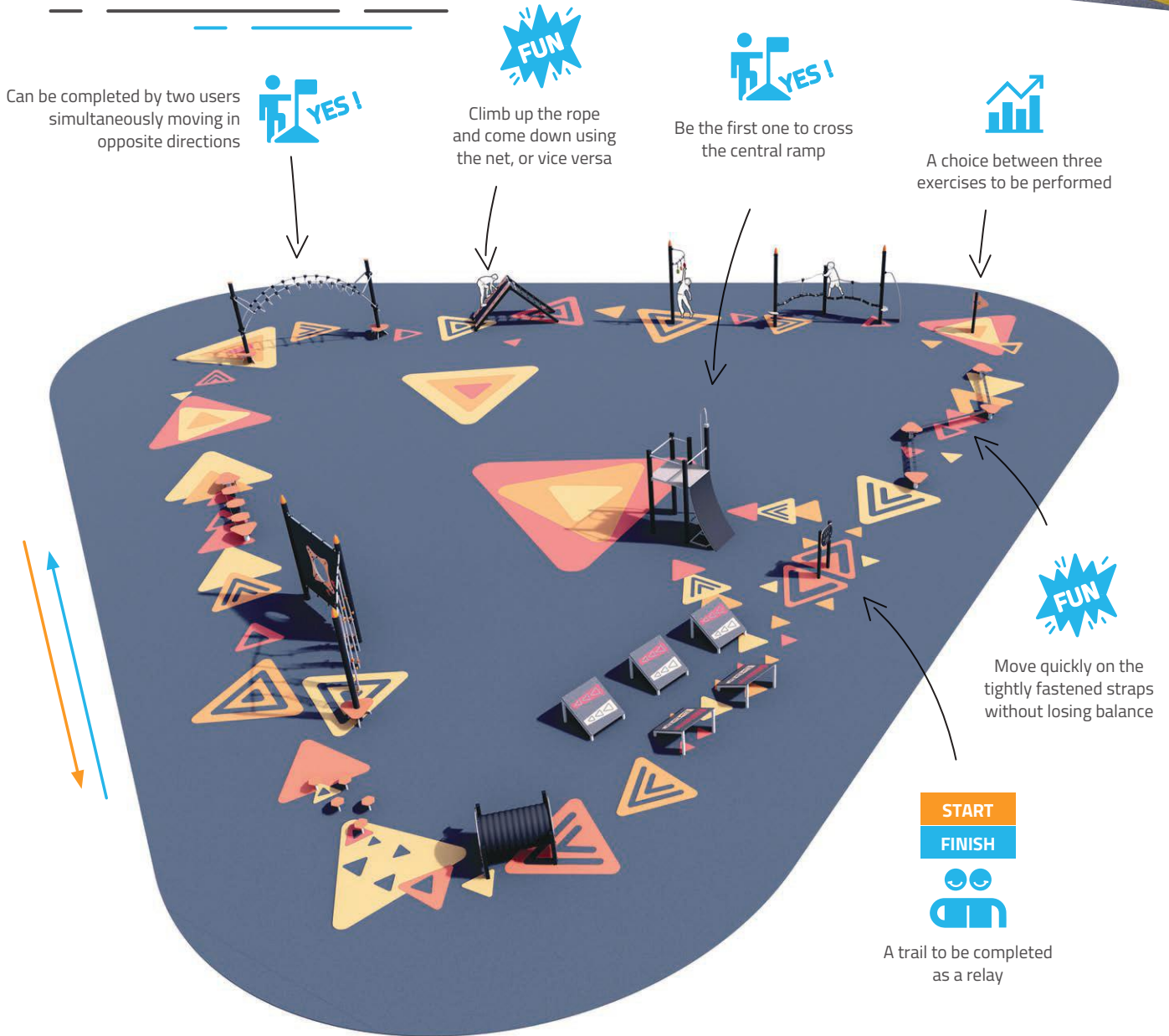

8+
*
>1,40 m

2,70 m

43

DIFFICULTY



* EN 1176: 6+ / 8+
EN 16630: >1,40 m



1=1,95 m
2=0,70 m
3=0,27 m

6+
>1,40 m

<0,60 m

4

16,5 m²

Steps
J5903®

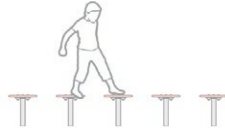

1=3,74 m
2=0,68 m
3=0,37 m

6+
>1,40 m

<0,60 m

2

23 m²

Unstable bridge
J5905®

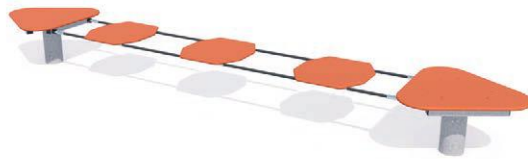
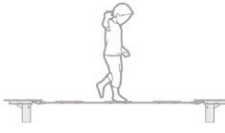

1=8,22 m
2=3,28 m
3=0,37 m

6+
>1,40 m

<0,60 m

10

44,5 m²

Slackline
J5910®

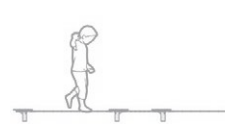

1=0,61 m
2=0,11 m
3=1,45 m

6+
>1,40 m

<0,60 m

1

39 m²

Stopwatch panel
J5914®



1=0,67 m
2=0,16 m
3=1,81 m

6+
>1,40 m

<0,60 m

1

10 m²

Exercise panel
J5912®





Tunnel
J5902®

6+ 0,60 m
>1,40 m

1 16,5 m²
1=1,38 m
2=1,17 m
3=1,04 m

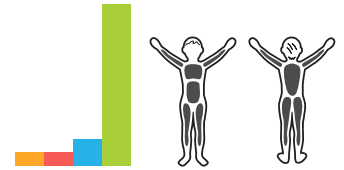
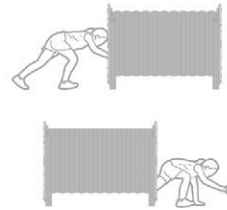
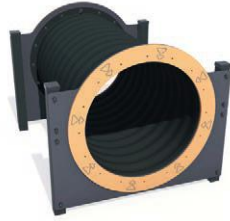

Suspended tunnel
J5909®

6+ 1,10 m
>1,40 m

3 21,5 m²
1=2,35 m
2=1,33 m
3=1,15 m

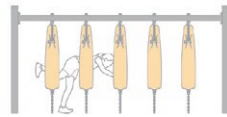

Climbing module
J5904®

6+ 2,70 m
>1,40 m

7 44 m²
1=5,34 m
2=1,61 m
3=3,01 m

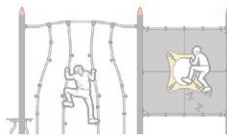

Winding tubes
J5911®

6+ 1 m
>1,40 m

4 27,5 m²
1=4,93 m
2=1,37 m
3=3,01 m

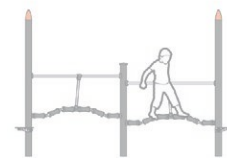

Aerial crossing
J5913®

6+ 1,55 m
>1,40 m

4 54 m²
1=10,51 m
2=3,37 m
3=3,21 m



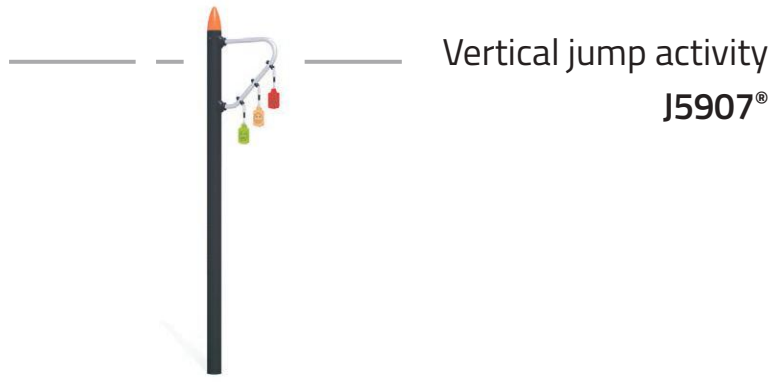

Vertical jump activity
J5907®

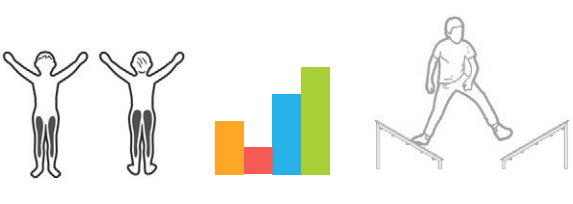
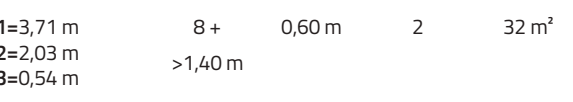

Slanted steps
J5901®

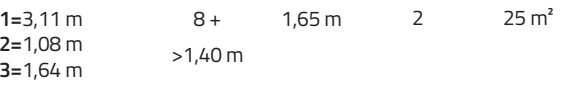

Climbing slope
J5906®

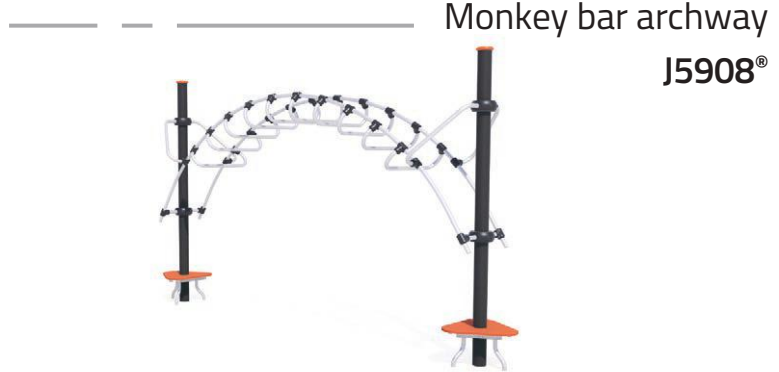
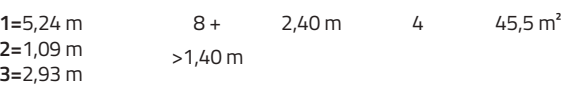

Monkey bar archway
J5908®

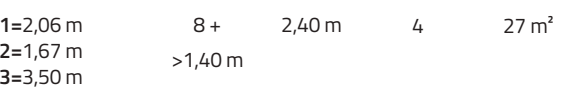

Ramp
J5915®



Junior parallel bars
JPS15-J-M



>1,40 m 0,60 m 1 16 m² 1=1,69 m
2=0,75 m
3=0,80 m

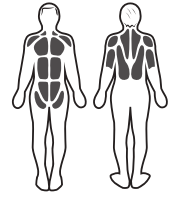

Junior double wall bars
JPS11-J-M

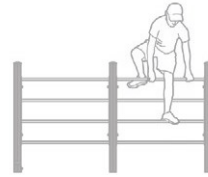

>1,40 m 1,30 m 2 16 m² 1=2,69 m
2=0,10 m
3=1,49 m

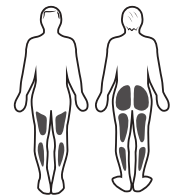

Junior leapfrog
JPS16-J-M

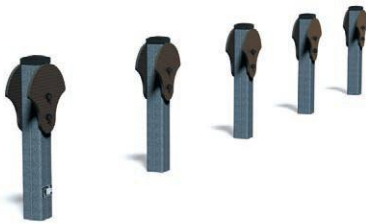

>1,40 m 0,70 m 2 23,5 m² 1=5,09 m
2=0,10 m
3=0,71 m

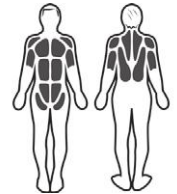

Junior hurdles
JPS12-J-M

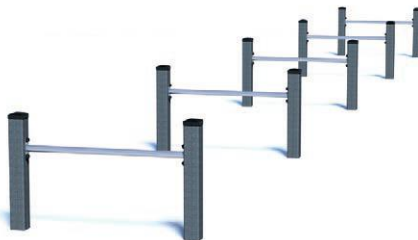

>1,40 m 0,40 m 2 53,5 m² 1=10,10 m
2=1,20 m
3=0,61 m

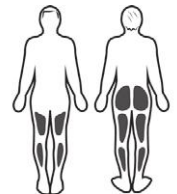

Junior slalom steppers
JPS10-J-M



>1,40 m 0,55 m 2 18,5 m² 1=2,26 m
2=1,19 m
3=2,21 m

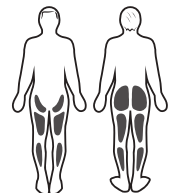

Junior monkey bars
JPS21-J-M

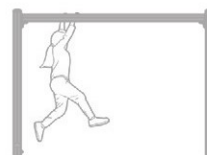

>1,40 m 0,70 m 2 18 m² 1=2,39 m
2=0,64 m
3=1,75 m

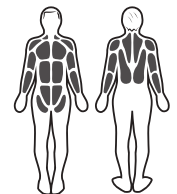



1=4,69 m
2=0,10 m
3=0,62 m

>1,40 m 0,55 m

2 22 m²

Balance beam
JPS14-M

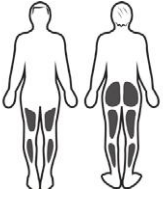

1=3,29 m
2=0,10 m
3=1,49 m

>1,40 m 1,20 m

2 18 m²

Senior support jump
JPS17-S-M

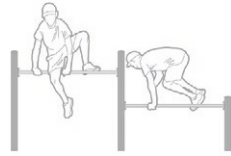
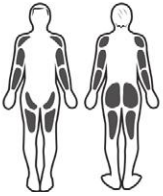

1=1,70 m
2=0,75 m
3=1,21 m

>1,40 m 1 m

1 16 m²

Senior parallel bars
JPS15-S-M

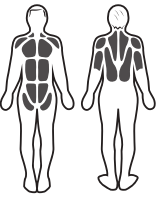

1=2,30 m
2=0,10 m
3=2,02 m

>1,40 m 1,80 m

2 17,5 m²

Senior horizontal bars
JPS19-S-M

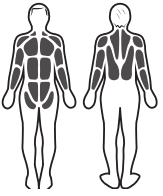

1=2,69 m
2=0,10 m
3=2,52 m

>1,40 m 2,40 m

2 24,5 m²

Senior double wall bars
JPS11-S-M

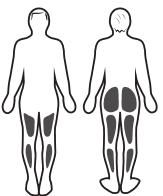

1=2,29 m
2=1,65 m
3=1,21 m

>1,40 m 1 m

2 20 m²

Senior push-up bars
JPS18-S-M

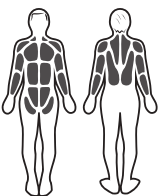



Senior leapfrog
JPS16-S-M

_____ >1,40 m 1 m

2 27,5 m² 1=6,29 m
2=0,10 m
3=1,01 m

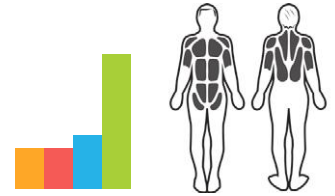

Springboard
JPS23-M

_____ >1,40 m 0,60 m

1 18 m² 1=2,04 m
2=0,94 m
3=0,62 m

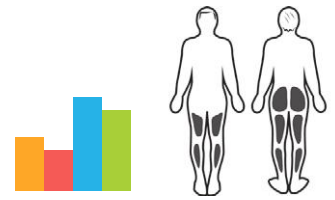

Senior abs bench
JPS13-S-M

_____ >1,40 m 0,60 m

1 18 m² 1=2,06 m
2=0,94 m
3=0,92 m

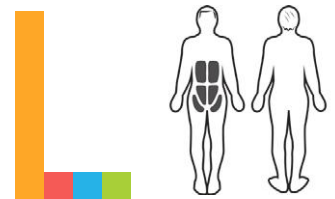
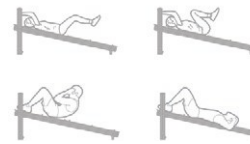
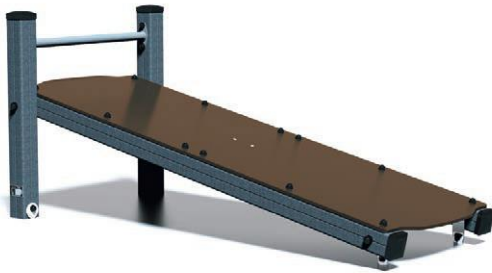

Senior hurdles
JPS12-S-M

_____ >1,40 m 0,80 m

2 61,5 m² 1=12,10 m
2=1,20 m
3=1,01 m

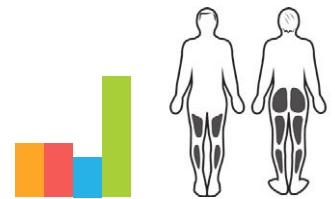

Senior jump bars
JPS20-S-M

_____ >1,40 m 0,50 m

1 21 m² 1=2,40 m
2=1,20 m
3=0,50 m

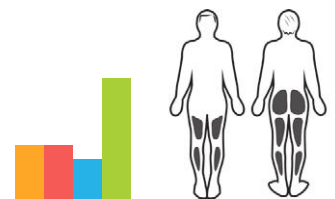
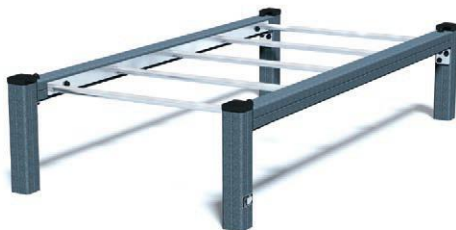

1=1,78 m
2=1,40 m
3=1,80 m

>1,40 m 1,55 m 1 22,5 m²

Climbing ladders
JPS22-M

1=2,40 m
2=0,65 m
3=2,51 m

>1,40 m 1,40 m 2 18 m²

Senior monkey bars
JPS21-S-M

1=0,10 m
2=0,25 m
3=1,21 m

Direction arrows
JPS31-M

1=2,30 m
2=0,04 m
3=1,80 m

Start-Finish sign
J3722

1=0,28 m
2=0,05 m
3=1,80 m

Walking trail signpost

J3736 J3735 J3734 J3733 J3732

The ACTI'Ninja Metal trails are supplied with special signage informing users of the difficulty level of each exercise and the cardio-intensity of the activity.

Over to you!

Design your own **ACTI'Ninja**[®] trail
BY PROLUDIC



Slanted steps



Slackline



Climbing slope

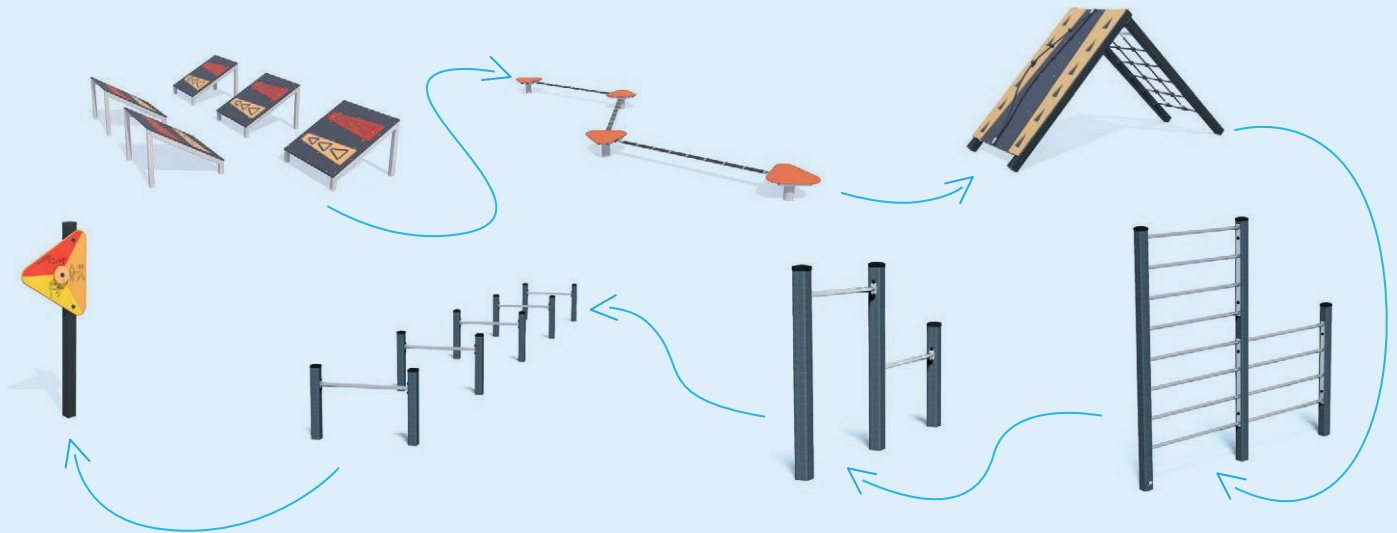

Exercise panel



Senior hurdles



Senior horizontal bars



Senior double wall bars



✓ 14+ trail



✓ Muscle strengthening



✓ Heart health



✓ Coordination



✓ Balance

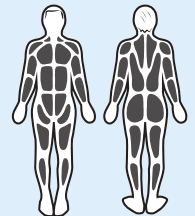

- ▶ Determine the age range
- ▶ Determine the number of pieces of apparatus
- ▶ Define your users' sports objectives
- ▶ Define the types of activities



Contact us
to finalise
your project!

Extra options

Include a stopwatch to challenge users!







Motivations to enjoy fun-sport



Optional. Volume-amplifying smartphone holder. For selfies, playing music, videos, etc.



Speed, tactics and team spirit inject pace and atmosphere into play areas!



Improving shots and passes with each match.



Team sport activities.



Group activities that encourage people to mix.



Ball games of all types: endless challenges for players of all ages!



MULTI-USE GAMES AREAS

Multi-Use Games Areas (MUGAs) are structures that appeal in particular to the young generation and provide facilities for various ball sports in a single location: football, basketball, handball, volleyball, hockey, badminton, etc.

These areas encourage social interaction among users and feature increasingly innovative accessories that maximise the fun sport's potential and offer users new shared experiences.

▶ 18 structures available with a wide range of personalisation options (fence heights and colours, access methods, adjustable basketball hoop heights, custom boards...)

▶ High-quality materials:

- Aluminium fences, collars flanges = anti-corrosion, solidity
- Galvanised and painted steel posts = resistance, durability

▶ Reinforced fence design:

- 3 horizontal tubes, 40mm diameter, 3mm thick
- Vertical tubes, 20mm diameter, 2mm thick
- The vertical tubes are inserted into the horizontal tubes to improve resistance to impacts from balls

▶ Anti-noise design:

- Fences made from aluminium, known for its acoustic absorption properties
- Central horizontal tube improves the structure's rigidity and stability
- Post/fence connection collars to reduce fence vibration

MULTI-USE GAMES AREAS

Accessories and fun-sports options to enhance the potential of multi-use games areas



Side or rear basketball hoop

2 possible heights

To create an additional play area at the back or play over the width of the court to include more users



Mini-goals

Maximise use and sharing of the court or pitch

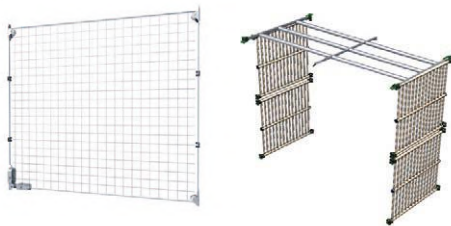

Ball nets / Goal ball stop fencing

Create a secure space to avoid having to retrieve balls from outside the structure

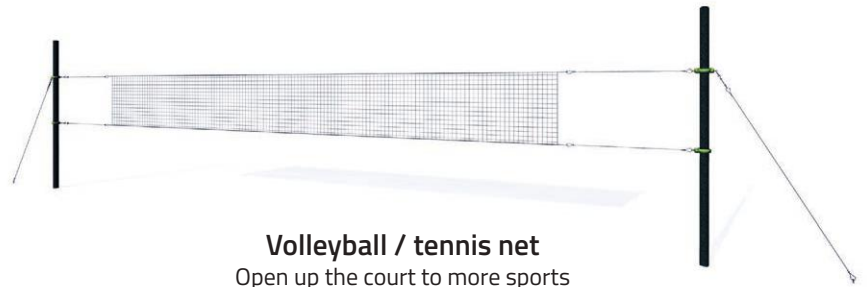

Volleyball / tennis net

Open up the court to more sports and supervised activities

Seat canopy

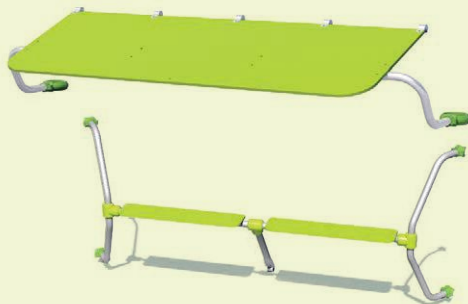

Side seats

With or without covers, for use as substitutes' benches or terraces

Coat hanger

To leave belongings before going to play



Smartphone holder

Inject energy into sessions with music (sound amplifier: + 10 dB)
Take selfies or videos



Shooting targets

Secured to the fences to test the precision of shots

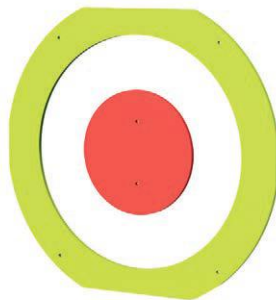

Vertical jump activity

Improve the quality of jumps

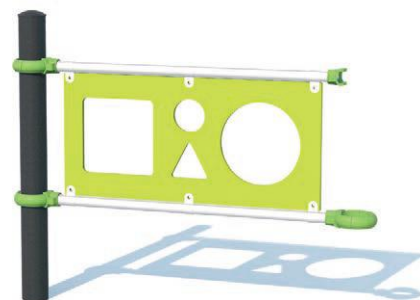

Tennis/ball skills training panel

Installed outside the pitch or court
To refine ball control with the foot or racket



Scoreboard

Increase and track results

Cycle rack

For easy parking of bikes (without taking up nearby public space)

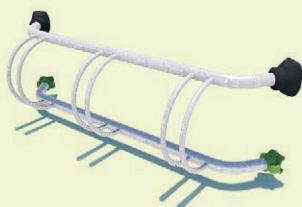

Customisable decorative panels

(engraved or with prints)



RAL

Personalised colour

Coordinate colours with the surrounding environment



MULTI-USE GAMES AREAS

J22225®



6+

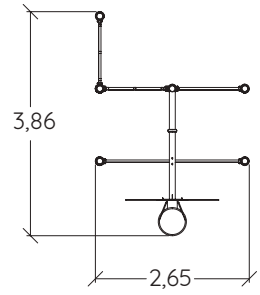

J22226®



6+

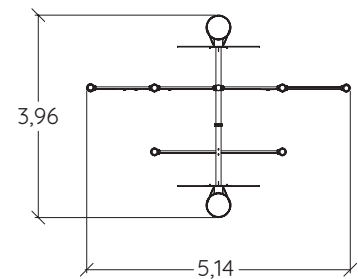

NEW
J22228



6+

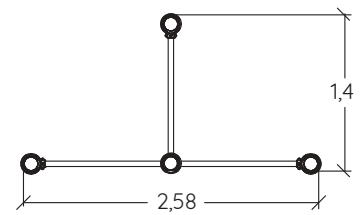



J22218®

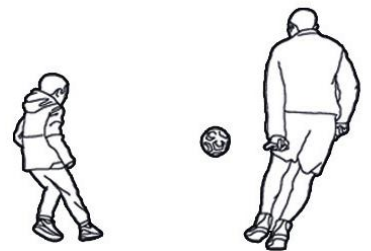
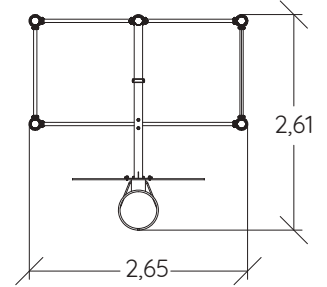

J22219®

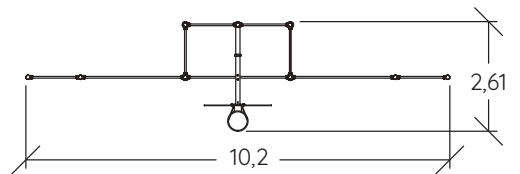

J22200®



6+

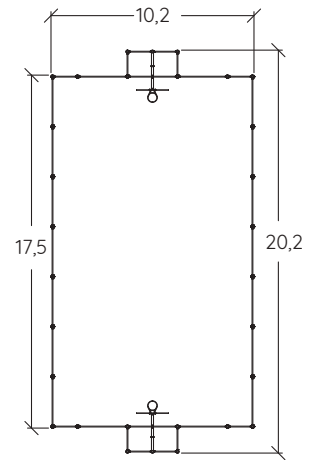

J22209®



6+

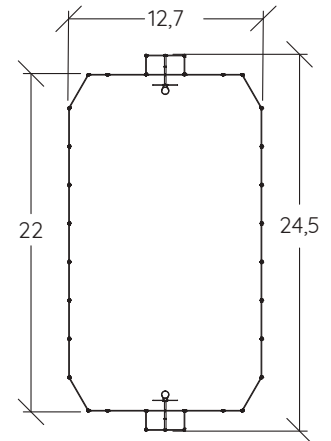



J22220®

6+

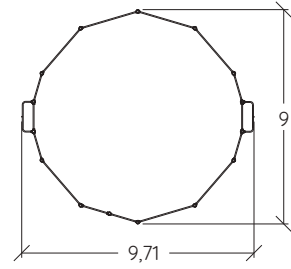

J22221®

6+

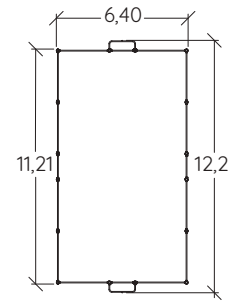

J22227®

6+

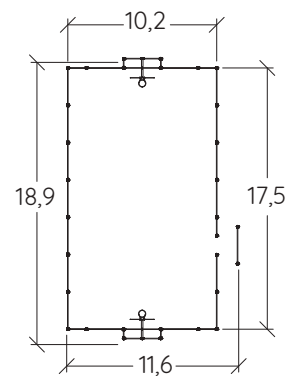
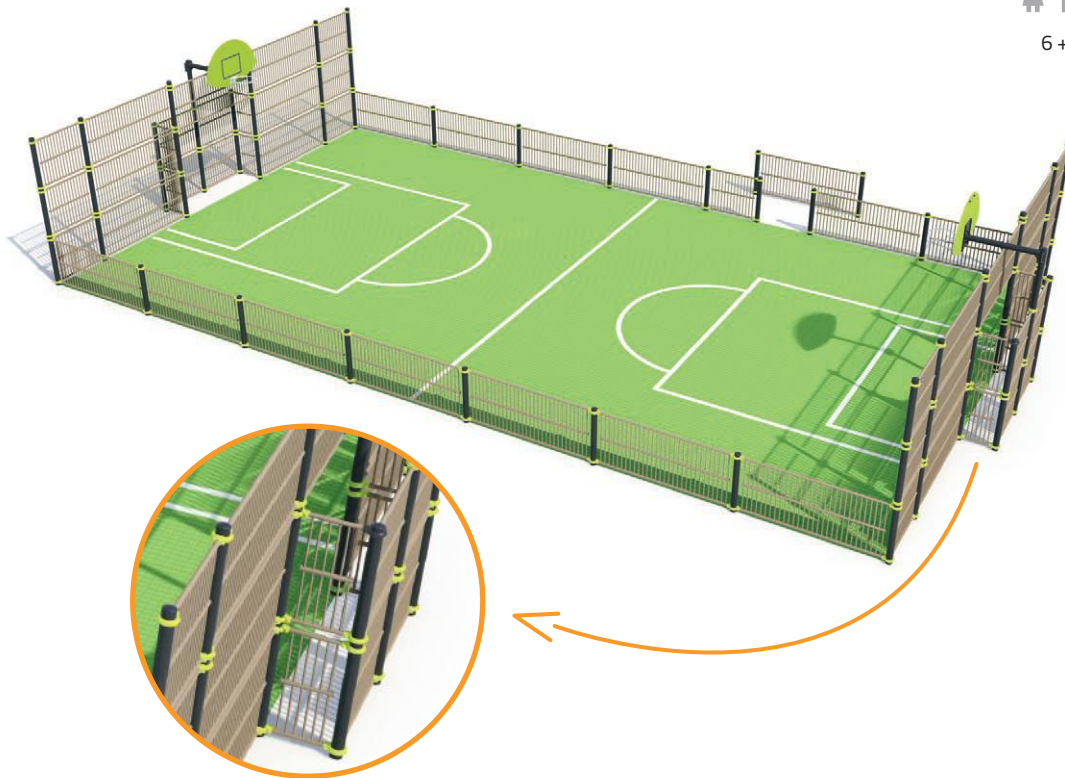

3 heights available

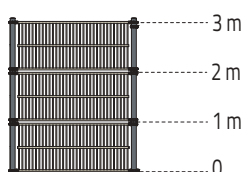



► Choose the dimensions and heights

- Length and width of the games area
- 3 heights available: 1m, 2m and 3m
- Square or angled corners

► Define the access points

- Inclusive access at the goal ends
- Inclusive access on the sides
- Gates on the sides
- Anti-cycle chicane

► Choose your colours

- Fence panels according to the RAL colour chart
- Collars available in black and green

► Define the surfacing and floor markings

- Unfinished or painted asphalt
- Artificial grass
- Markings: football, basketball, volleyball, hand-ball, etc.



R1002



4

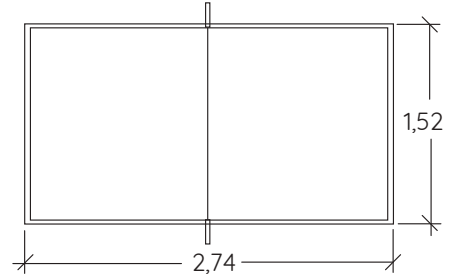

R37-8000



6+

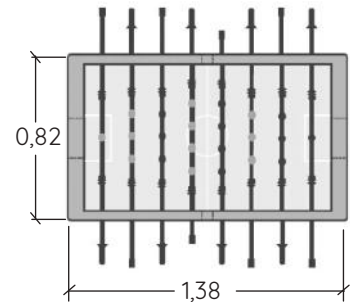

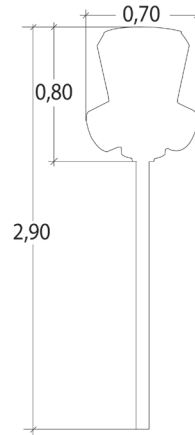

R2212

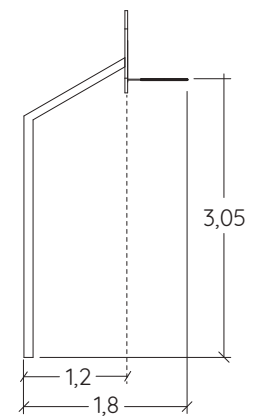
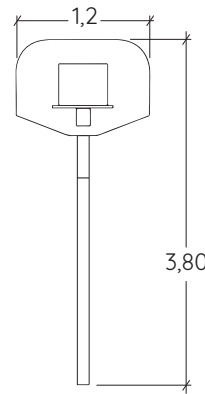

R1390

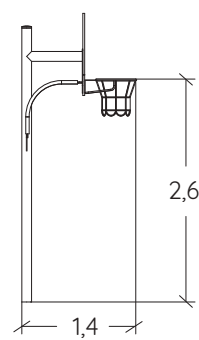
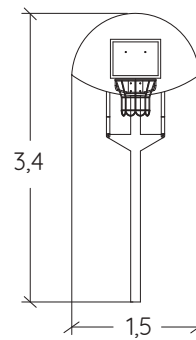

J2211



Motivations to enjoy fun-sport



Adrenaline, speed
and freestyle moves!



Technique perfected
with repeated use of the
equipment.



Activities practised individually
or in a group, with the
encouragement of friends.



Group activities
that encourage
people to mix.



Physical or strategic challenges.
Keeping your balance, resisting
speed, maintaining your
concentration.



DYNAMIC STRUCTURES

Designed for adrenaline-loving pre-teens, teenagers and young adults, the Dynamic Structures encourage users to push their limits and embrace new challenges in a fun environment.

Most of the equipment is inspired by extreme sports, generally practiced in the air, on water, or in the mountains. These sports have been reinterpreted in games encompassing a wide range of physical activities: heights, speed, acrobatics and rotation.

- ▶ Kite-surfing, snowboarding, parachuting, windsurfing, climbing... these sports are the main inspirations behind the Dynamic Structures range.
- ▶ The equipment has received the Janus de l'Industrie award, a design label from the French Design Institute.

DYNAMIC STRUCTURES

Skysurf

J3505

Skysurf is a fun interpretation of 2 water sports: windsurfing and kite-surfing.

The activity is carried out by two people. One person stands on a slightly inclined platform, in a dynamic position: the other is suspended on a handle, ready to resist the centrifugal force and perform beautiful acrobatic movements.

Working in coordination to create rhythm and speed, both users can enjoy the sweeping arcs of the Skysurf and experience the sensation of gliding over water and flying above the waves.



“ Sliding, acrobatics and adrenaline! ”



The platform requires less physical effort and allows mixed use

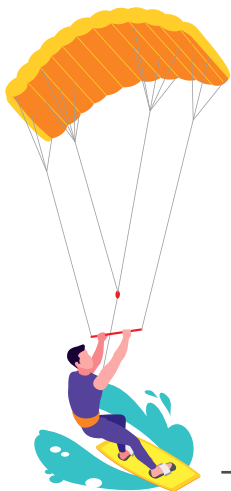

Coordination between the 2 users is essential to create the rotating movement and build speed



Maintain the acrobat's position for as long as possible



Great travel distance and freedom of movement. Centrifugal force and acrobatics



12 +



2,35 m



2



1=4,92 m
2=1,27 m
3=3,22 m

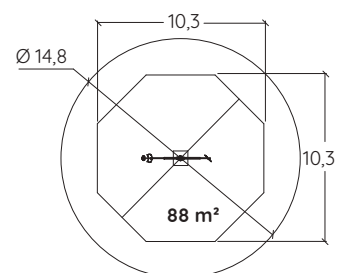
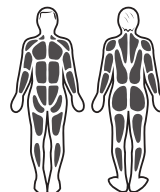

Aeroskate J2581-M



The Aeroskate is a fun take on skateboarding. A curved rail allows great travel distance and the board is propelled by synchronised movements.

To initiate and maintain the gliding effect, skaters need to coordinate their movements by pushing with their legs and pulling the chains with their arms. While working with a lack of balance, users need to continuously adjust the position of their body to maintain the maximum travel distance.

This challenge requires quick learning followed by the reward of an amazing gliding sensation.

“ Surf & Fun! ”



Management of lack of balance and the lateral movement from one end to the other guarantees adrenaline thrills



Learning the technique allows users to control their body and its movements in the space



Stay on the board for as long as possible and travel further

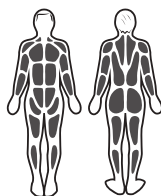
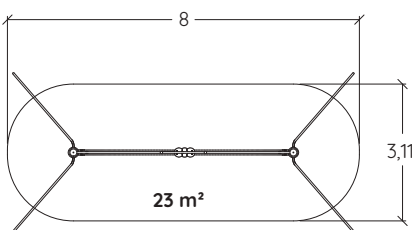

6 +



1,50 m



1



1=7,80 m
2=3,70 m
3=3,00 m

Turnfly J3504-N

The Turnfly gives you the impression of floating up to the clouds...

Inspired by acrobatic sports such as skydiving, kite-surfing, or wing foiling, the movement of this structure is initiated by the two users running at speed until they take off from the ground.

The centrifugal force then requires a firm grip on the handles, which have a 360° rotation system that increases the sensation of being carried along by the wind.



“ Dynamic suspension! ”



Speed combined with rotation gives a sensation of floating in the air



Stay suspended for as long as possible



Coordination between the users is essential to create the movement and build speed

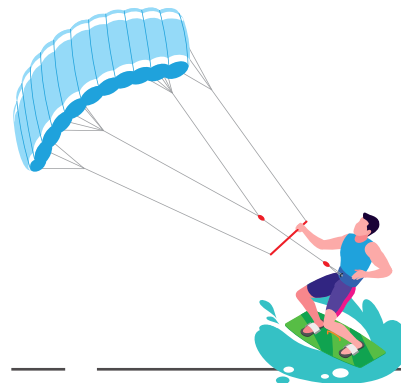

12 +	0,90 m	2	1=3,66 m 2=0,35 m 3=3,01 m

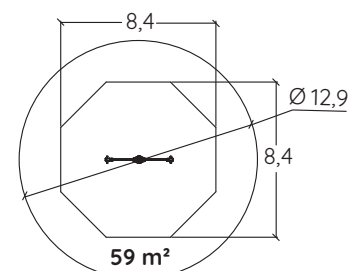
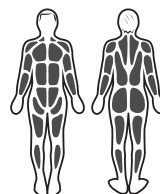



Rodeoboard J3501

The Rodeoboard requires technique and dexterity to generate, maintain and control the movement.

Users stand on an oscillating platform mounted on 3 powerful springs and hold onto a solid support bar. They need to defy the laws of physics and gravity to keep steady and deal with the inevitable lack of balance.

The platform is designed for use by up to 4 people. With additional people, there is the challenge of synchronising movements before performing their very own rodeo show.

“ Stay on track without falling! ”



The platform and the central grab bar allow access for all users from age 8 years



Turning and moving in every direction!



Stay on the rotating platform for as long as possible



Coordination between the users is essential to create the movement and build speed

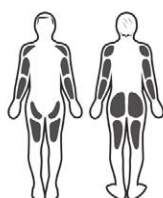
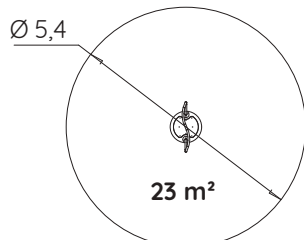

8+



0,55 m



4



1=0,84 m
2=0,84 m
3=1,50 m

DYNAMIC STRUCTURES

Altima

J3503

With its double grip system on the feet or hands, the Altima requires a technique similar to climbing.

You pull yourself up the pole using the strength of your arms, legs and abdominals. All muscles help to take you higher, assisted by the right technique and coordination! When a skilled climber makes it all the way to the top, almost 4 metres above the ground, they can then turn the flag to mark the achievement of reaching the summit.



The grip system can be adapted to all body shapes



Complete the climb, embrace the challenge!



Climbing, up to a height of 4 metres, creates great sensations



Soar to new heights!



14 +



2,80 m



1



1=0,76 m
2=0,50 m
3=4,20 m

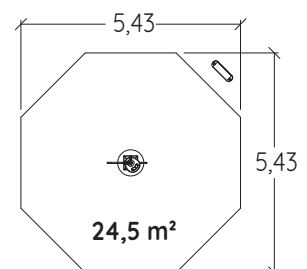
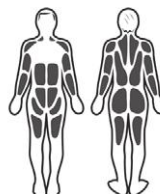



Stay standing inside the structure for as long as possible

Rollrunner J3510®



It turns fast, very fast and even faster!

E-Rollrunner J3511®

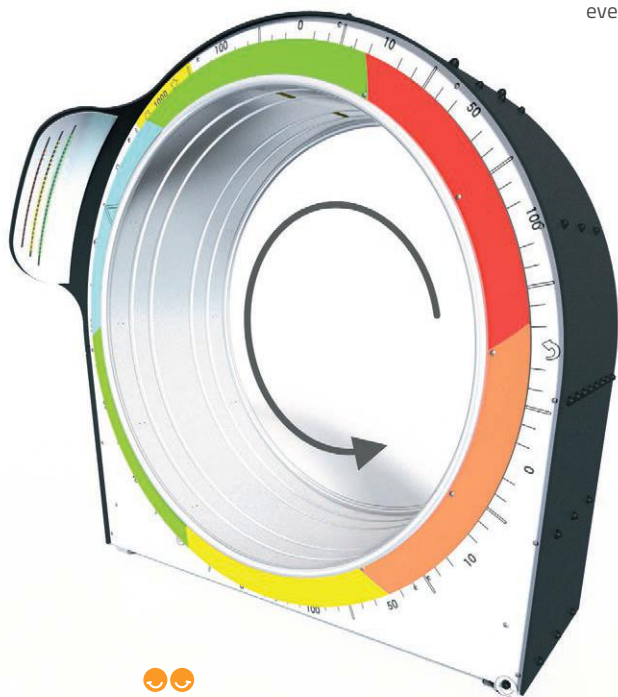

Coordination between the users is essential to create the movement and build speed



Running in a wheel without losing your balance



The Rollrunner is a vertical wheel with a 1.80 meter diameter with movement generated from the inside. Whether crawling, walking or running, users choose the right pace to maintain their balance.

This structure adds a fun and sporty touch to a play area and is ideal for challenges: who can turn it the fastest? Who can stop the wheel at the right time to line up the patterns? Who can achieve the best score shown on one of the sides?

The electronic version includes a sound and light panel on the structure that is activated according to the speed of the wheel. The faster the turns, the more the colour LEDs light up and, as the ultimate reward... music is played when the top speed is reached!

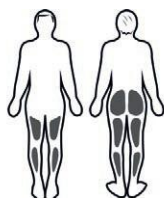
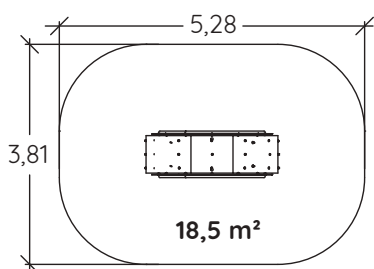

6+



0,70 m



3



1=2,28 m
2=0,79 m
3=2,25 m

DYNAMIC STRUCTURES

Swing Ball

J3508

A dynamic but less physical activity, the Swing Ball is a reflex and strategy game inspired by pinball and table football.

The players stand around the circle and try to control the sometimes surprising, trajectories of a ball inside and score as many points as possible.

Whether in attack or defence mode, they manoeuvre the circular tube in all directions, trying to position the ball in one of the cages opposite their opponents' goals to have the best shooting angle.

You need quick reactions and thinking to win: a great social atmosphere is guaranteed around the Swing Ball!



“ Pinball wizard! ”



Be faster and more agile than your opponents to attack and defend!



An activity suitable for everyone, children of all generations and genders (from 8 years)

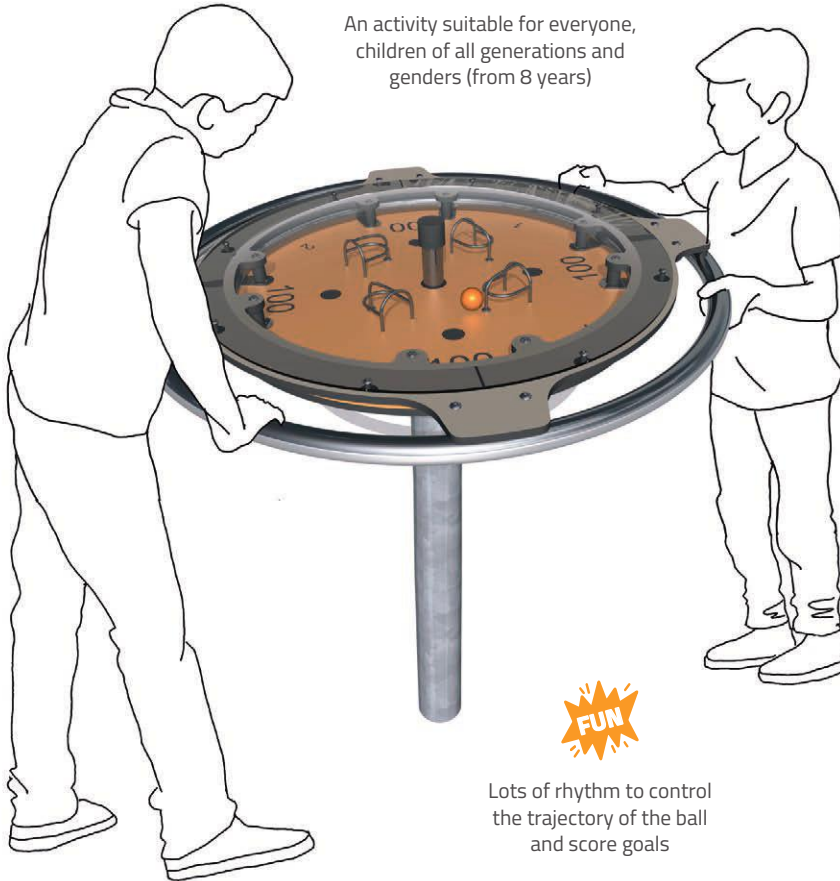

Up to 4 players can compete, individually or in teams of 2



Lots of rhythm to control the trajectory of the ball and score goals



8+ 0 m 4 1=1,10 m
2=1,10 m
3=1,08 m

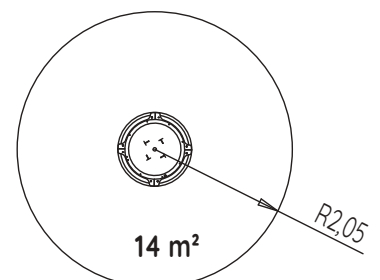

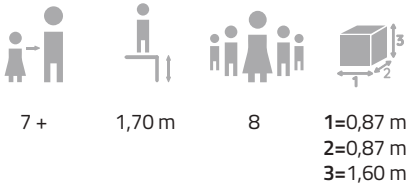

Stay suspended for as long as possible

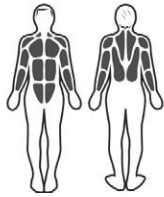
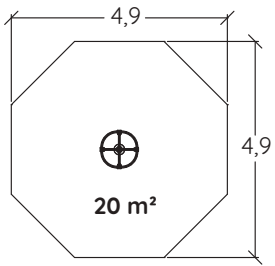

Roll-Up
J2591



Coordination between the users is essential to create the movement and build speed

The Roll-Up is rotating play equipment that is set in motion by users' momentum. The hanging position and centrifugal force create a real sense of flight.

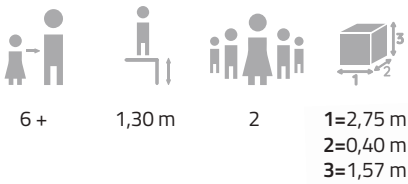

The Hip-Hop combines rotational and vertical bouncing movements. Users need to synchronise their movements to accelerate and increasingly rise up from the ground, in complete safety thanks to the wide seats and grab handles.

Hip-Hop
J2410

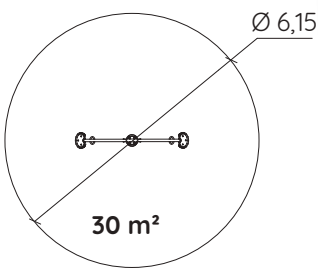
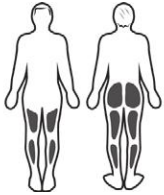

An activity suitable for everyone



Speed combined with rotation gives a sensation of flying into the air





TRAMPOLINES

The trampoline invites users of all ages to embark on adventures full of twists and turns!

It is easy to use and the fun starts straight away: you simply need to push on your feet to take off and then build momentum and confidence to progress to higher and more acrobatic jumps.

The trampoline is also ideal to encourage a natural approach to sports. It helps children develop motor skills, coordination, balance and muscle strength. It invites adults to go back to their childhood... or to practice a fitness activity guaranteeing a complete workout with cardio, muscle-building, toning and balance.

- ▶ In a 3D version with sloping side jump surfaces or installed at ground level, the trampoline is an ideal addition to every fun-sport area for different user groups.
- ▶ Ground-level trampolines are protected by a frame with rounded edges and allow easy access to the centre for users in wheelchairs. With a helping hand from a carer or playmate, they can then gently experience the sensation of bouncing.

Motivations to enjoy fun-sport



Virtual coaching with exercise videos and training programmes.



Volume-amplifying smartphone holder. For selfies, playing music, videos, etc.



Adrenaline and freestyle moves!



Technique perfected with repeated use of the equipment.



This activity can be practiced individually or in a group, with friends or family.



Group activities that encourage people to mix.



Jumps and acrobatic moves.

Fitness trampoline

NEW J37200®

Creatively designed, this innovative trampoline oozes fun and lets users exercise without even noticing it! Consisting of one flat surface, two sloping side surfaces and a central pillar for safe bouncing, this item guarantees users a completely new bouncing sensation. The smartphone holder built into the apparatus allows users to place their phones in front of them and use the ACTI'FUN app to access all the fun-sport activities that can be performed on this equipment.



Activity to be accompanied by music or shared on social media

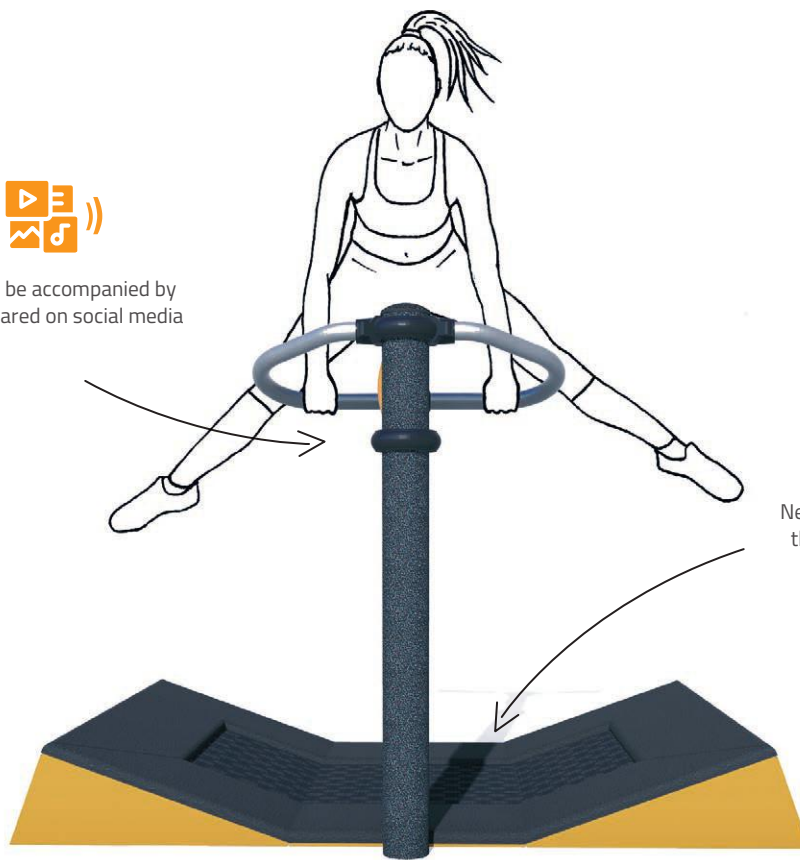

New sensations thanks to the 3D bounce surfaces

Jump straight up or to the side, with legs bent or apart, front-on or twisting... Many different moves are possible and guarantee varied use that evolves with practice

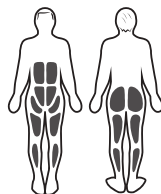
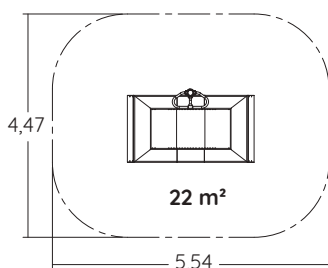

>1,40 m



1 m



1



1=2,26 m
2=1,28 m
3=0,29 m

TRAMPOLINES



Square trampoline

R34-ETP-000



3+

1 m

1

1=1,50 m

2=1,50 m

3=0,03 m

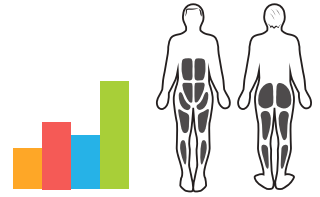
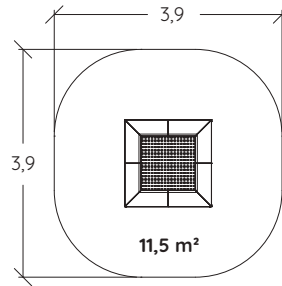
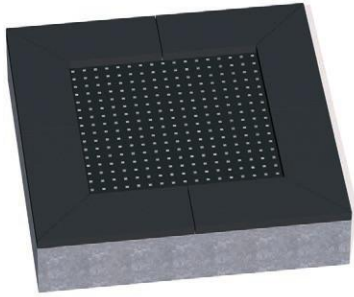

Round trampoline

R34-ETP-010



3+

1 m

1

1=1,50 m

2=1,50 m

3=0,03 m

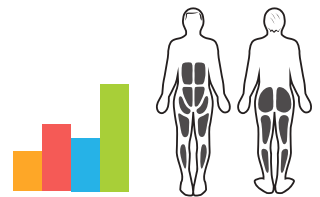
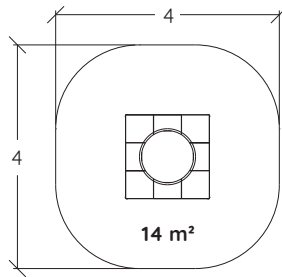
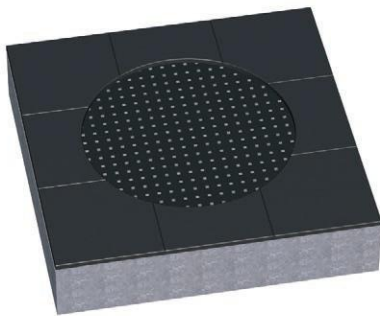



1=2,00 m
2=2,00 m
3=0,00 m

3 +

1 m

1

Large square trampoline



R34-ETP-500

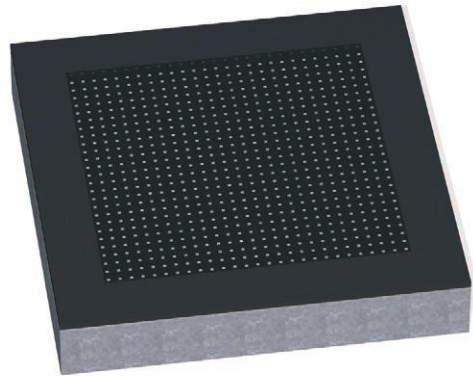
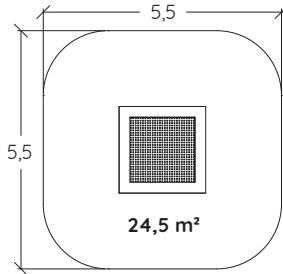
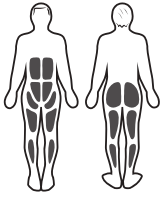

1=4,40 m
2=1,60 m
3=0,03 m

3 +

1 m

2

Rectangle trampoline



R34-ETP-004

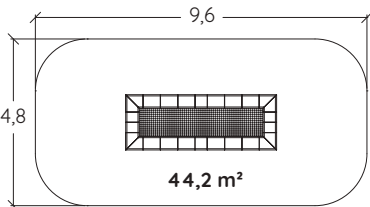
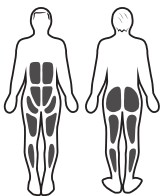

Increase the fun-sports potential of your area!

Various patterns are available as standard but the possibilities are endless...



Clock

Circular floor exercises, balance, coordination of movements and changes in direction.



Even more FUN!
The surface is also used

Rhythm ladder

For use in warm-ups to work on holds and increase speed.



▶ Chasse steps, cross steps, supported by the hands, hopping or jumping.



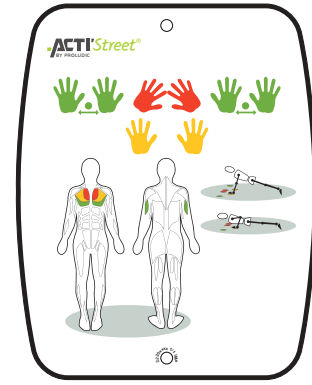

Hands Each coloured hand represents a different type of press-up and a different muscle group.

The panel shows the user where to place his or her hands to work the target muscle group.



- ▶ Diamond press-up, normal press-up, wide grip press-up and narrow grip press-up.

Pattern embedded directly in the surface

Trail arrows Indicates the direction of the trail and emphasises the concept of a circuit.

Stimulates physical activity and injects energy into key areas of the trail (roll-call zone, take-off zone, landing zone and restart zones).



Examples of **ACTI'FUN** layouts



...in a campsite



A layout that is a real attraction for holiday leisure time!

Dynamic Structures appeal to the whole family: kids can have fun running in the Rollrunner, while older children enjoy sliding, climbing, flying and spinning in all directions on equipment inspired by extreme sports.

This play area makes the campsite more attractive, providing an additional promotional tool to appeal to holidaymakers seeking high-quality leisure facilities and memorable social connections.



...in a park

A large-scale installation in the heart of the city which brings together urban life, with health and wellbeing opportunities.

The space is structured around numerous fun-sport activity hubs subdivided by age group. The different areas are clearly distinguished but are close enough to one another to encourage contact and communication, permit shared family times and create a genuine centre for urban life.



...in a residential district

A truly local facility that reinforces the community and social dynamic of the district.

The space, which consists of a Street Workout structure, fitness equipment and outdoor furniture, encourages socialising around mixed, intergenerational fun-sport activities.



...in a school

An installation that is both recreational and educational.

The various fun-sport structures arranged within the school playground help support the children's play-based learning and provide teachers with great facilities.



...in a sports complex



A multi-purpose solution to complement indoor sports facilities.

The site is developing its full sports potential with an outdoor fitness area adjacent to the town's gym.

The types of activities offered and the variations make this sports area ideal for use by schools and local sports associations. It is also becoming a place for practicing fun sports activities with family or friends in leisure time.



...in a shopping centre

A design incorporating the customer journey and emphasising the brand's dynamic image.

The creation of a fun sports area with structures designed for a wide range of users as well as the furniture makes the shopping centre a more attractive destination. From a sales retail space, it becomes a place of friendly interaction that encourages the whole family to visit, spend time and return.

It offers multi-generation activities that are accessible for everyone. The benches and tables installed nearby also allow customers to take a break from shopping before setting off for more purchases with renewed energy.



J2		J37201®	30	J5221	40	JPS17-S-M	55
J2211	71	J37202®	29	J5222	37	JPS18-S-M	55
J22200®	66	J37203®	28	J5223	35	JPS19-S-M	55
J22209®	66	J37204®	28	J5224	41	JPS20-S-M	56
J22218®	65	J37205®	28	J5225	44	JPS21-J-M	54
J22219®	65	J37206®	28	J5901®	53	JPS21-S-M	57
J22220®	67	J37207®	29	J5902®	52	JPS22-M	57
J22221®	67	J37208®	29	J5903®	51	JPS23-M	56
J22225®	64	J37209®	27	J5904®	52	JPS31-M	57
J22226®	64	J37210®	26	J5905®	51	R1	
J22227®	67	J37211®	26	J5906®	53	R1002	70
J22228	64	J37212®	30	J5907®	53	R1390	71
J2410	81	J37213®	30	J5908®	53	R2	
J2581-M	75	J37214®	30	J5909®	52	R2212	71
J2591	81	J37215®	27	J5910®	51	R3	
J3		J37216®	27	J5911®	52	R34-ETP-000	84
J3501	77	J37217®	27	J5912®	51	R34-ETP-004	85
J3503	78	J37218®	26	J5913®	52	R34-ETP-010	84
J3504-N	76	J37219®	29	J5914®	51	R34-ETP-500	85
J3505	74	J3722	57	J5915®	53	R37-8000	70
J3508	80	J37220®	26	JP			
J3510®	79	J3732	57	JPS10-J-M	54		
J3511®	79	J3733	57	JPS11-J-M	54		
J37100®	21	J3734	57	JPS11-S-M	55		
J37101®	20	J3735	57	JPS12-J-M	54		
J37102®	19	J3736	57	JPS12-S-M	56		
J37103®	18	J5		JPS13-S-M	56		
J37105®	22	J5216	38	JPS14-M	55		
J37106®	23	J5217	42	JPS15-J-M	54		
J37107®	24	J5218	39	JPS15-S-M	55		
J37108®	25	J5219	43	JPS16-J-M	54		
J37200®	29, 83	J5220	36	JPS16-S-M	56		

Discover all our products on our website
proludic.com



- ▶ **The metal posts** are made from galvanised steel to meet requirements for robustness and safety of play structures.

An optimum lifespan is guaranteed for the posts in a wide range of climatic conditions thanks to galvanisation of the steel, one of the most effective processes to combat corrosion, and the application of a polyester powder that is extremely resistant to ultraviolet light and temperature variations.

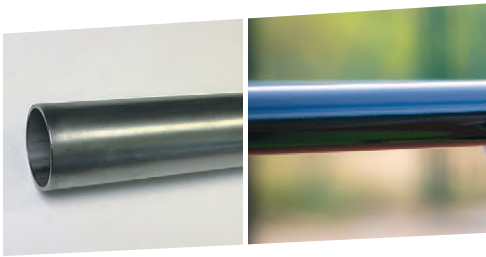

- ▶ **The tubes.** Unaffected by graffiti, weather and urban pollution, the stainless steel tubes require limited maintenance and are resistant to highly aggressive solvents.

They are used in suspension and traction equipment, and are made from electro-galvanised steel (diameter 34mm) and stainless steel (diameter 40mm), coated with an epoxy paint.



- ▶ **The collars** are made from painted aluminium.

Aluminium is a corrosion-resistant material thanks to the natural formation of an oxide layer on the surface. The application of a coating of polyester epoxy paint on the aluminium makes it extremely resistant to ultraviolet rays and temperature variations, guaranteeing a long lifespan for the equipment in a wide range of environments.

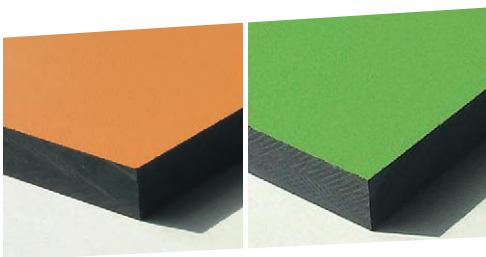

- ▶ **The coloured panels** are made from a 13mm thick compact material (HPL). Robust in construction, it has excellent weather and vandal resistance properties.

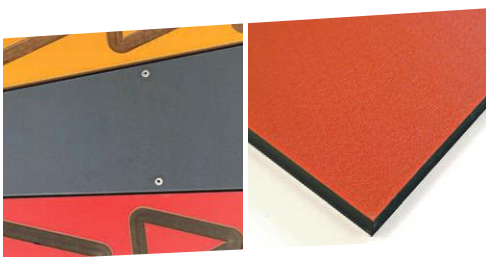

- ▶ **The climbing ramps and orange floors of the ACTI'Ninja modules** are machined from 12mm thick anti-slip polyethylene panels. The anti-slip polyethylene provides excellent grip and performance on obstacles.

The surfaces of references J5901 and J5906 are also made from inlaid compact laminate (HPL) panels.



Guarantees

Proludic is committed to the quality and durability of its products.

In addition to using carefully selected materials and applying the highest manufacturing standards, Proludic provides extensive guarantees.

25 years for any structural failure of sport or play products due to a material or manufacturing failure of:

- Panels (lacquered plywood / coloured compact / polyethylene)
- Posts and supporting structures (painted galvanised steel, galvanised steel, stainless steel)
- Stainless steel tubes

15 years for structural failure of products due to a material defect or a manufacturing defect on the solid wood planks and timber frame posts.

10 years for any structural failure of sport or play products due to a material or manufacturing failure of:

- Metal components (with the exception of springs, moving or mechanical parts and fixings)
- High density plastic parts (with the exception of moving or mechanical parts)
- Non-slip plywood and compact panels
- Planks and treated timber frame posts

5 years for any structural failure of sport or play products due to a material or manufacturing failure of:

- Springs and mechanical systems
- Moulded or rotary moulded plastic parts (with the exception of moving parts)
- Metal crimps and rope assemblies

2 years for any defect or manufacturing fault of component parts.

The guarantee includes the provision of spare parts or free repair but does not include intervention by a technician.

The colours reproduced in this brochure may not be true to life, Proludic reserves the right to change specifications and make product improvements to any of our products at any time without notice. Information in this brochure was correct at the time of printing. While every effort has been made to ensure the accuracy of information, Proludic cannot accept any responsibility for any errors or omissions and this brochure does not form part of any contract.

Photo credit: Proludic & Freepik



PROLUDIC LTD
The Play Hub
Bradmore Business Park
Loughborough Road
Bunny, Nottinghamshire
NG11 6QA
Tel. 01159 823 980
E-Mail: info@proludic.co.uk
proludic.co.uk